

# NON-ISOLATED DC/DC CONVERTERS

## 12V Input / 1.0 – 5.0V Output / 10A

**bel**  
POWER PRODUCTS

BP06VRPB-10A

### VRPB-10A Series

### RoHS Compliant

- Nonisolated
- Industry standard pinout
- Fixed frequency
- High efficiency means less power dissipation
- Optimized for cost
- Remote on/off
- Remote sense
- Undervoltage lockout
- Over current and short circuit protection
- Overtemperature shutdown

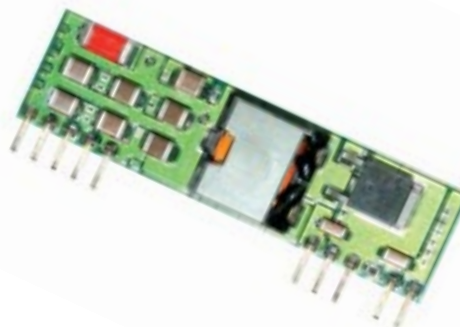

### Description

The Bel VRPB-10A series modules are non-isolated, step down DC/DC power converters that operate from a nominal 12V source. These converters are available in a range of output voltages from 1.0V to 5.0V. They are packaged in an industry standard single-in-line footprint and provide a maximum 10A output. Standard features include remote on/off, remote sense, over current and short circuit protection, overtemperature shutdown and output voltage adjust. Remote on/off logic is an optional feature. These products may be used almost anywhere low-voltage silicon is employed and a 12V source is available. Typical applications include file servers, routers, line cards and other computing and communications equipment.

### Applications

- Telecommunications
- Networking
- Computers and peripherals

### Options

- Remote on/off logic

### Part Number Selection

Output Voltage	Input Voltage	Max. Output Current	Max. Output Power	Typical Efficiency	Part Number	Part Number Active Low Option
5.0V	12V	10A	50W	94%	VRPB-10A50S	VRPB-10A50L
3.3V	12V	10A	33W	92%	VRPB-10A33S	VRPB-10A33L
2.5V	12V	10A	25W	90%	VRPB-10A25S	VRPB-10A25L
2.0V	12V	10A	20W	88%	VRPB-10A20S	VRPB-10A20L
1.8V	12V	10A	18W	87%	VRPB-10A18S	VRPB-10A18L
1.5V	12V	10A	15W	86%	VRPB-10A15S	VRPB-10A15L
1.2V	12V	10A	12W	83%	VRPB-10A12S	VRPB-10A12L
1.0V	12V	10A	10W	82%	VRPB-10A10S	VRPB-10A10L

©2006 Bel Fuse Inc. Specifications subject to change without notice. 02.06

Bel Fuse Inc. 206 Van Vorst Street, Jersey City, NJ 07302 • Tel 201-432-0463 • Fax 201-432-9542 • www.belfuse.com

page 1

BP06VRPB-10A

## Absolute Maximum Ratings

Parameter	Symbol	Min	Typical	Max	Unit
Continuous Input Voltage	V <sub>in</sub>	-0.3		15	V
Output Enable Terminal Voltage	V <sub>outen</sub>	-0.3		15	V
Ambient Temperature	T <sub>amb</sub>	-40		85	°C
Storage Temperature	T <sub>stor</sub>	-40		125	°C

Note: Use beyond the maximum ratings may cause a reliability degradation of the DC/DC converter or may permanently damage the device.

## Input Specifications

Parameter	Symbol	Min	Typical	Max	Units
Operating Input Voltage	V <sub>in</sub>	10.8		13.2	V
Input Current	I <sub>in</sub>			5.5	A
No Load Input Current				60	mA
Remote Off Input Current			3	15	mA
Input Reflected Ripple Current <sup>1</sup>				120	mA <sub>rms</sub>
Input Reflected Ripple Current (P-P) <sup>1</sup>				300	mApk
I <sup>2</sup> t Inrush Current Transient			0.08	0.12	A <sup>2</sup> s
Turn On Voltage Threshold			9.7		V
Turn Off Voltage Threshold		8.0	8.8	10.0	V

Note: Input capacitance 22µF tantalum.

1. With simulated source impedance of 800nH, 5Hz to 20MHz.

# NON-ISOLATED DC/DC CONVERTERS

## 12V Input / 1.0 – 5.0V Output / 10A



BP06VRPB-10A

### Output Specifications

Parameter	Module	Symbol	Min	Typical	Max	Units
Output Voltage Set Point <sup>1</sup>	5.0V	V <sub>out</sub>	4.900	5.0	5.100	V
	3.3V		3.247	3.3	3.353	
	2.5V		2.460	2.5	2.540	
	2.0V		1.968	2.0	2.032	
	1.8V		1.771	1.8	1.829	
	1.5V		1.476	1.5	1.524	
	1.2V		1.181	1.2	1.219	
	1.0V		0.984	1.0	1.016	
Load Regulation	5.0V			10	20	mV
	3.3V			6	16	
	2.5V			6	12	
	2.0V			5	10	
	1.8V			5	9	
	1.5V			3	7	
	1.2V			3	6	
	1.0V			3	5	
Line Regulation	5.0V			2	10	mV
	3.3V			2	10	
	2.5V			2	8	
	2.0V			2	6	
	1.8V			2	5	
	1.5V			2	5	
	1.2V			2	5	
	1.0V			2	5	
Regulation Over Temperature -40° to +85° C	5.0V			17	35	mV
	3.3V			15	30	
	2.5V			12	25	
	2.0V			11	22	
	1.8V			10	20	
	1.5V			9	18	
	1.2V			8	16	
	1.0V			7	15	
Total Output Voltage Regulation	5.0V			29	65	mV
	3.3V			23	56	
	2.5V			20	45	
	2.0V			18	38	
	1.8V			17	34	
	1.5V			14	30	
	1.2V			13	27	
	1.0V			12	25	

Note: All specifications are typical at nominal input, full load at 25° C unless otherwise stated.

1. V<sub>in</sub> = 12V, I<sub>out</sub> = full load, T<sub>a</sub> = 25° C.

BP06VRPB-10A

### Output Specifications

Parameter	Module	Symbol	Min	Typical	Max	Units
Output Ripple and Noise <sup>2</sup>	5.0V			50	75	mVp-p
	3.3V			45	60	
	2.5V			40	55	
	2.0V			30	45	
	1.8V			30	45	
	1.5V			30	45	
	1.2V			25	40	
	1.0V			20	35	
Output Ripple and Noise <sup>2</sup>	5.0V			17	25	mVrms
	3.3V			14	22	
	2.5V			10	15	
	2.0V			9	15	
	1.8V			8	12	
	1.5V			6	10	
	1.2V			5	8	
	1.0V			5	8	
Output Current Range	All	I <sub>out</sub>	0		10	A
Output DC Current Limit	All	I <sub>outlim</sub>	13		22	A
Short Circuit Surge	All	I <sub>outsurge</sub>		0.8	1.5	A <sup>2</sup> s
Turn on Time	All	T <sub>on</sub>			80	ms
Overshoot at Turn On	All			0	3	%
Output Capacitance	All	C <sub>out</sub>	0		3300	μF

Note: All specifications are typical at nominal input, full load at 25° C unless otherwise stated.  
2. 0 - 20MHz BW, 22μF tantalum cap on output.

# NON-ISOLATED DC/DC CONVERTERS

## 12V Input / 1.0 – 5.0V Output / 10A



BP06VRPB-10A

### Output Specifications

Parameter	Module	Symbol	Min	Typical	Max	Units
<b>Transient Response <sup>3</sup></b>						
$\Delta V$ 50% to 100% of Max Load	5.0V			200	250	mV
Settling Time		Ts		50	80	$\mu s$
$\Delta V$ 100% to 50% of Max Load				200	250	mV
Settling Time		Ts		50	80	$\mu s$
<b>Transient Response <sup>3</sup></b>						
$\Delta V$ 50% to 100% of Max Load	3.3V			160	200	mV
Settling Time		Ts		50	80	$\mu s$
$\Delta V$ 100% to 50% of Max Load				160	200	mV
Settling Time		Ts		50	80	$\mu s$
<b>Transient Response <sup>3</sup></b>						
$\Delta V$ 50% to 100% of Max Load	2.5V			180	220	mV
Settling Time		Ts		50	80	$\mu s$
$\Delta V$ 100% to 50% of Max Load				180	220	mV
Settling Time		Ts		50	80	$\mu s$
<b>Transient Response <sup>3</sup></b>						
$\Delta V$ 50% to 100% of Max Load	2.0V			140	180	mV
Settling Time		Ts		50	80	$\mu s$
$\Delta V$ 100% to 50% of Max Load				140	180	mV
Settling Time		Ts		50	80	$\mu s$

Note: All specifications are typical at nominal input, full load at 25° C unless otherwise stated.  
 3. di/dt = 0.5A/uS, Vin = 12VDC, Ta = 25° C, and with a 22 $\mu$ F tantalum cap on output.

BP06VRPB-10A

## Output Specifications

Parameter	Module	Symbol	Min	Typical	Max	Units
<b>Transient Response <sup>3</sup></b>						
$\Delta V$ 50% to 100% of Max Load	1.8V			140	180	mV
Settling Time		Ts		50	80	$\mu s$
$\Delta V$ 100% to 50% of Max Load				140	180	mV
Settling Time		Ts		50	80	$\mu s$
<b>Transient Response <sup>3</sup></b>						
$\Delta V$ 50% to 100% of Max Load	1.5V			140	180	mV
Settling Time		Ts		50	80	$\mu s$
$\Delta V$ 100% to 50% of Max Load				140	180	mV
Settling Time		Ts		50	80	$\mu s$
<b>Transient Response <sup>3</sup></b>						
$\Delta V$ 50% to 100% of Max Load	1.2V			100	150	mV
Settling Time		Ts		50	80	$\mu s$
$\Delta V$ 100% to 50% of Max Load				100	150	mV
Settling Time		Ts		50	80	$\mu s$
<b>Transient Response <sup>3</sup></b>						
$\Delta V$ 50% to 100% of Max Load	1.0V			100	150	mV
Settling Time		Ts		50	80	$\mu s$
$\Delta V$ 100% to 50% of Max Load				100	150	mV
Settling Time		Ts		50	80	$\mu s$

Note: All specifications are typical at nominal input, full load at 25° C unless otherwise stated.  
 3. di/dt = 0.5A/ $\mu s$ , Vin = 12VDC, Ta = 25° C, and with a 22 $\mu F$  tantalum cap on output.

# NON-ISOLATED DC/DC CONVERTERS

## 12V Input / 1.0 – 5.0V Output / 10A



BP06VRPB-10A

### General Specifications

Parameter	Module	Symbol	Min	Typical	Max	Units
Efficiency <sup>1</sup>	5.0V	$\eta$	91	94		%
	3.3V		89	92		
	2.5V		87	90		
	2.0V		85	88		
	1.8V		84	87		
	1.5V		83	86		
	1.2V		80	83		
	1.0V		79	82		
Switching Frequency	All	Fsw	180	200	220	kHz
Overtemperature Shutdown	All	Tc		130		°C
Output Voltage Trim Range <sup>2</sup>	All		90		110	%
Remote Sense Compensation	All				10	%
Weight	All			10		g

1. Vin=12V, full load and Ta=25° C.
2. 1V module is 95% to 110%.

### Control Specifications

Parameter	Module	Symbol	Min	Typical	Max	Units
Remote On/Off	All	Vouten				V
Signal Low (Unit Off)	V7PB-10AxxS		-0.3		0.4	V
Signal High (Unit On)			2.8		13.2	V
Signal Low (Unit On)	V7PB-10AxxL		-0.3		0.4	V
Signal High (Unit Off)			2.8		13.2	V

BP06VRPB-10A

**Efficiency Data**

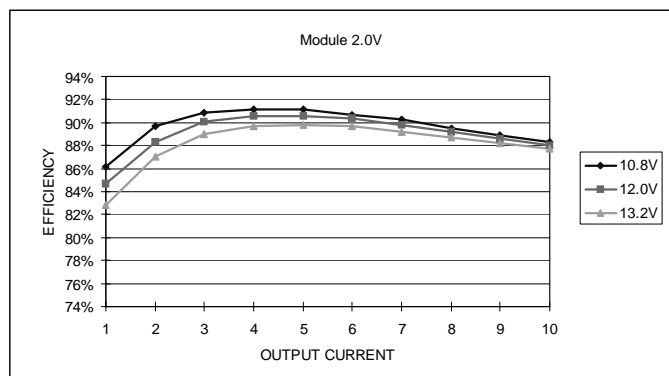
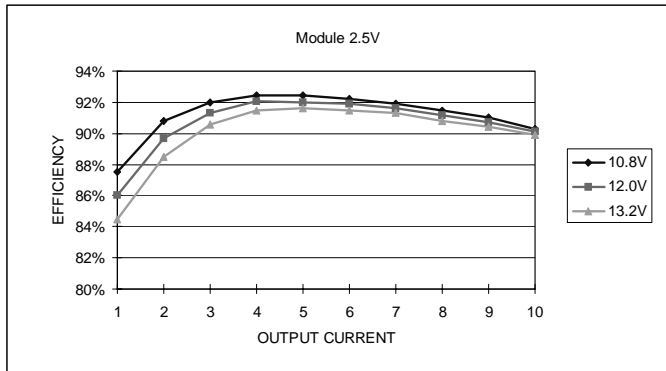
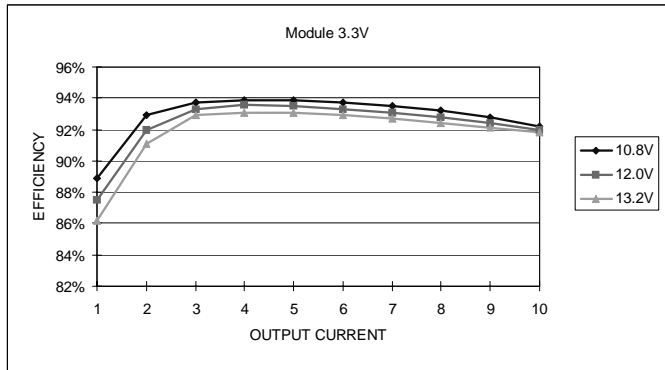
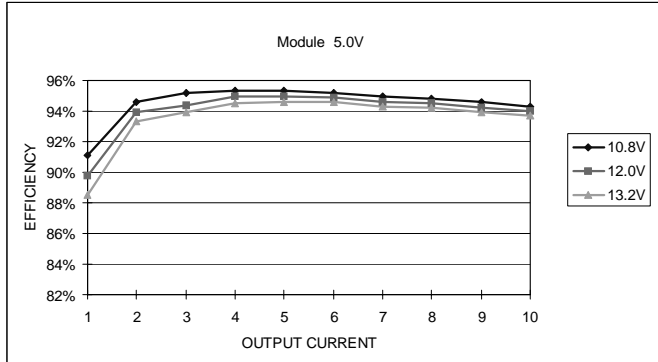

# NON-ISOLATED DC/DC CONVERTERS

12V Input / 1.0 – 5.0V Output / 10A



BP06VRPB-10A

## Efficiency Data

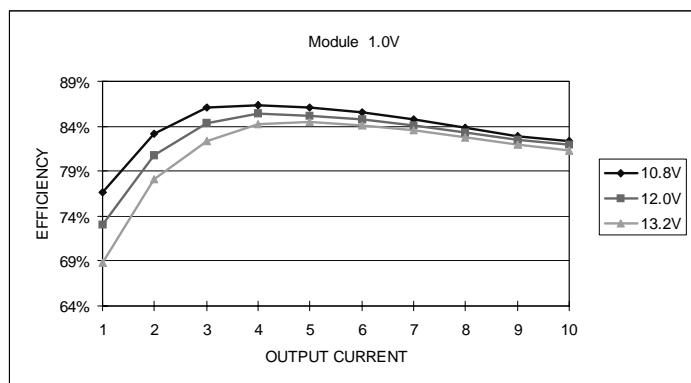
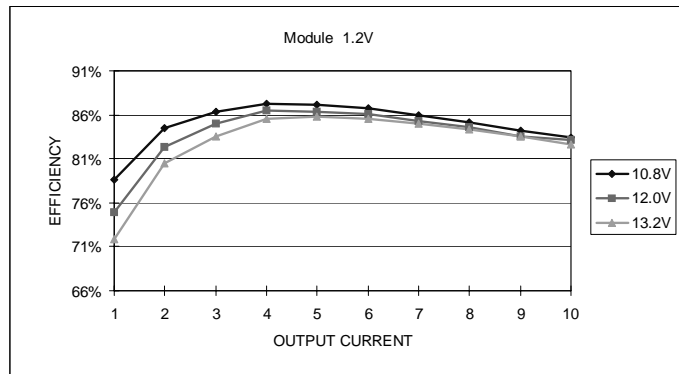
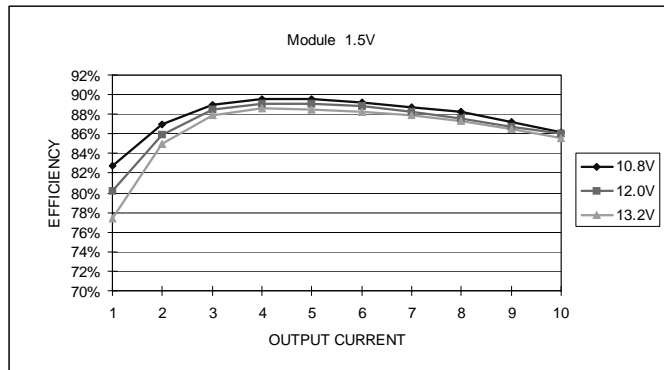
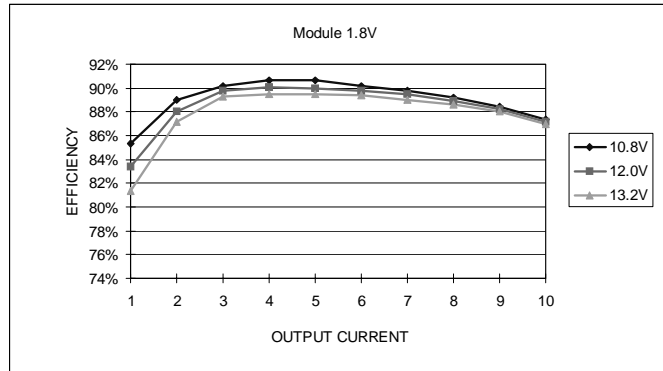

BP06VRPB-10A

### Ripple and Noise

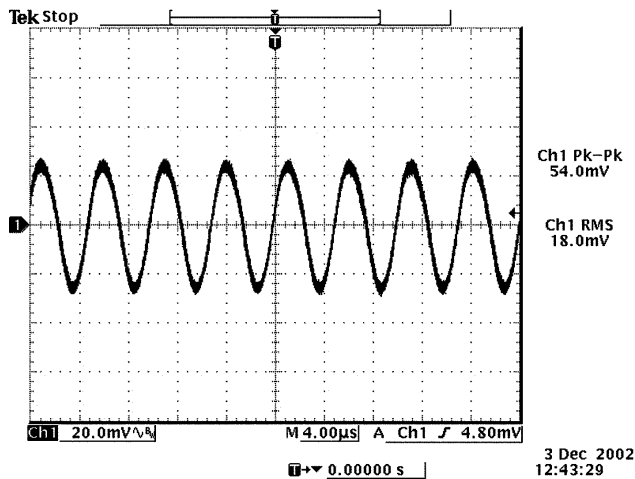

Ripple and noise at full load and 12Vdc input, 5.0Vdc output, full load with an external 22µF tantalum capacitor and Ta=25° C

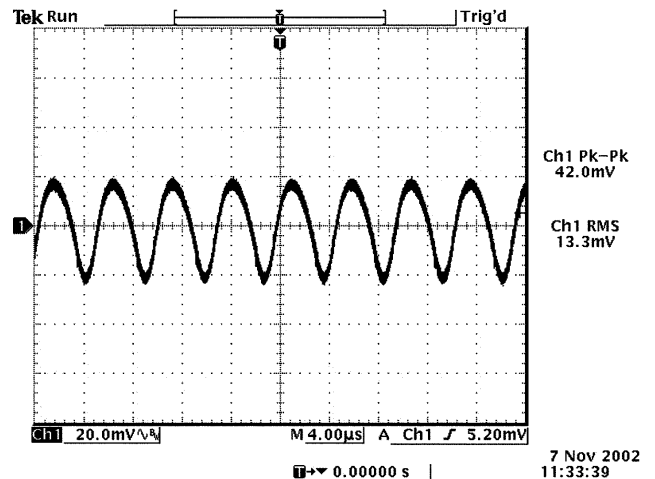

Ripple and noise at full load and 12Vdc input, 3.3Vdc output, full load with an external 22µF tantalum capacitor and Ta=25° C

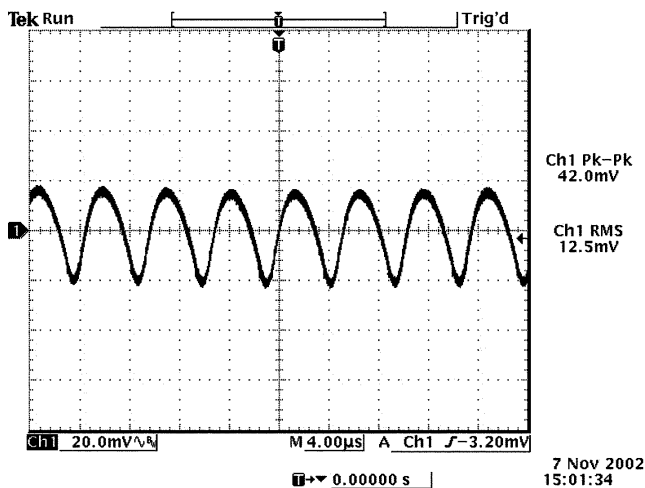

Ripple and noise at full load and 12Vdc input, 2.5Vdc output, full load with an external 22µF tantalum capacitor and Ta=25° C

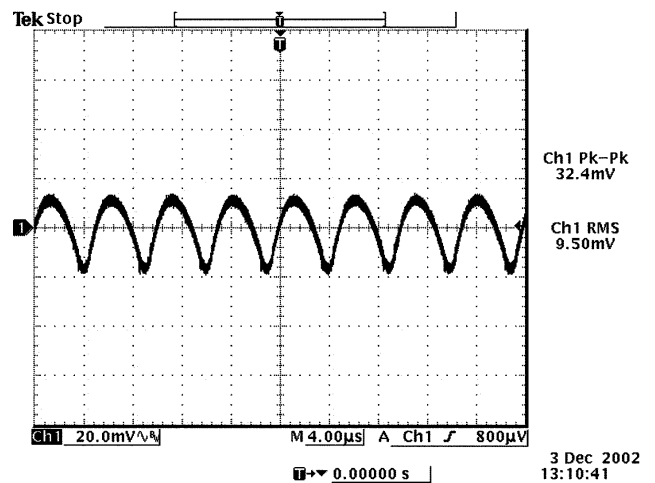

Ripple and noise at full load and 12Vdc input, 2.0Vdc output, full load with an external 22µF tantalum capacitor and Ta=25° C

# NON-ISOLATED DC/DC CONVERTERS

## 12V Input / 1.0 – 5.0V Output / 10A



BP06VRPB-10A

### Ripple and Noise

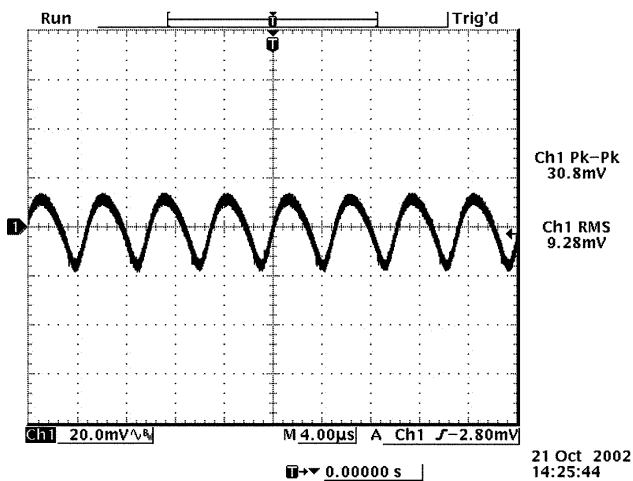

Ripple and noise at full load and 12Vdc input, 1.8Vdc output, full load with an external 22µF tantalum capacitor and Ta=25° C

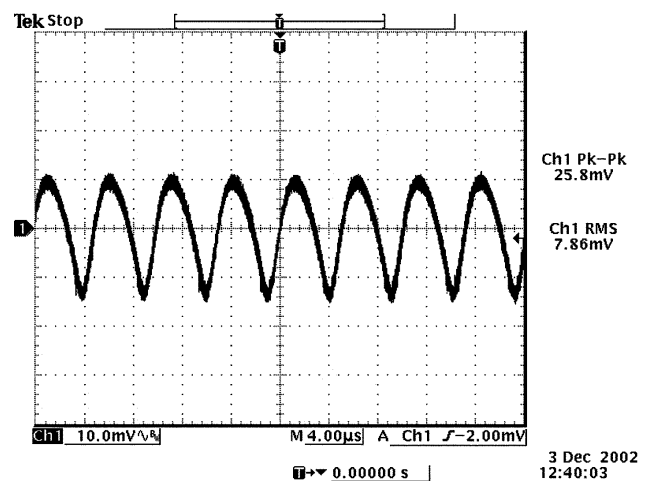

Ripple and noise at full load and 12Vdc input, 1.5Vdc output, full load with an external 22µF tantalum capacitor and Ta=25° C

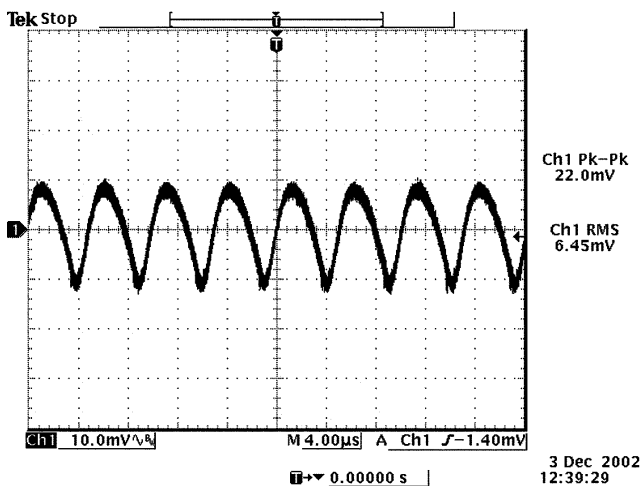

Ripple and noise at full load and 12Vdc input, 1.2Vdc output, full load with an external 22µF tantalum capacitor and Ta=25° C

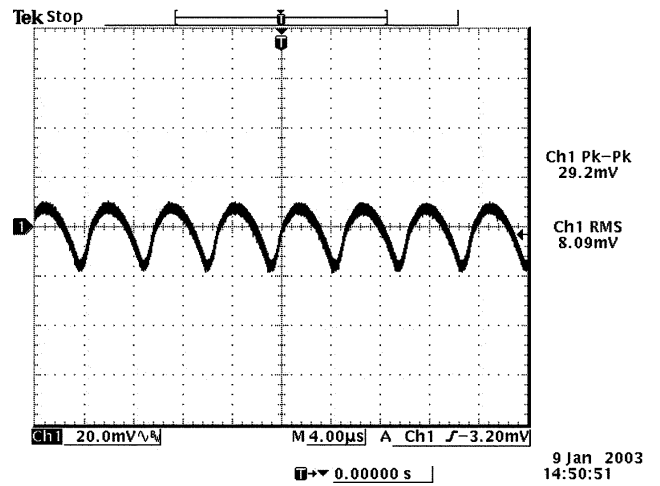

Ripple and noise at full load and 12Vdc input, 1.0Vdc output, full load with an external 22µF tantalum capacitor and Ta=25° C

BP06VRPB-10A

### Transient Response

Transient response:  $di/dt = 0.5A/\mu S$ , external load capacitance  $C_o = 22\mu F$  (Tantalum capacitor)

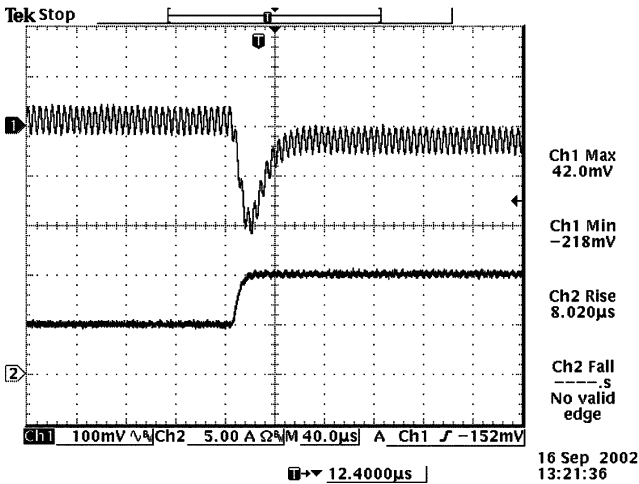

Vout=5.0V  
50% to 100% load transients at 12V input and Ta=25° C

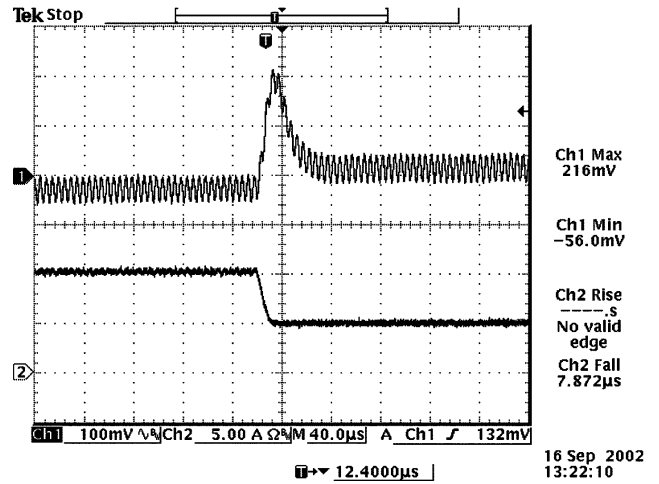

Vout=5.0V  
100% to 50% load transients at 12V input and Ta=25° C

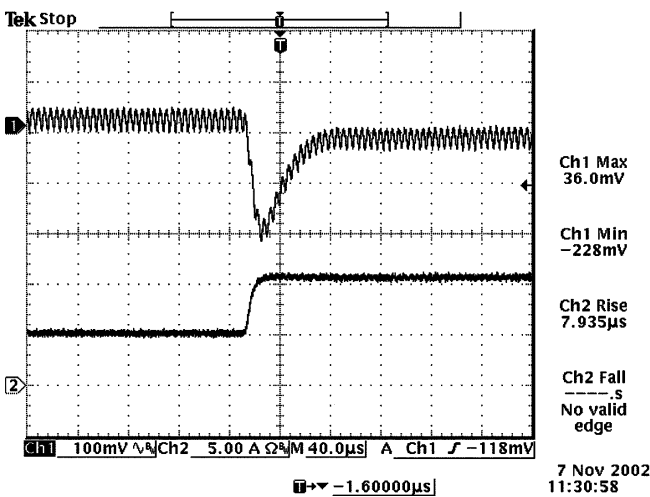

Vout=3.3V  
50% to 100% load transients at 12V input and Ta=25° C

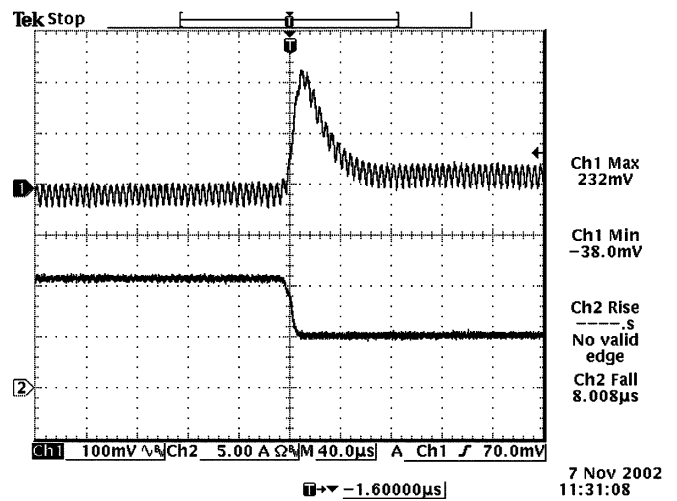

Vout=3.3V  
100% to 50% load transients at 12V input and Ta=25° C

# NON-ISOLATED DC/DC CONVERTERS

## 12V Input / 1.0 – 5.0V Output / 10A



BP06VRPB-10A

### Transient Response

Transient response:  $di/dt = 0.5A/\mu S$ , external load capacitance  $C_o = 22\mu F$  (Tantalum capacitor)

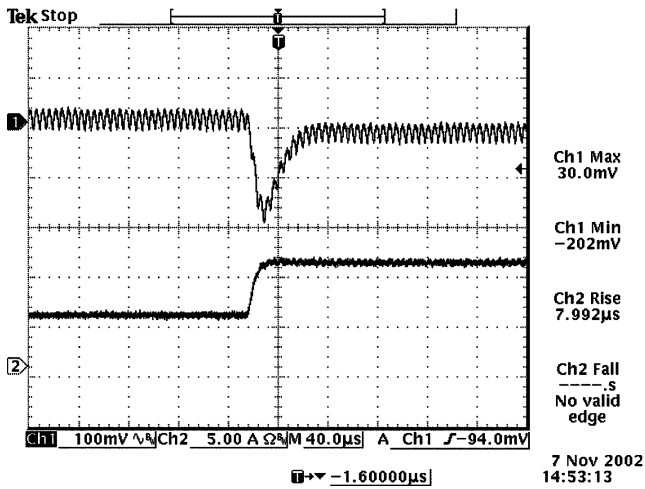

$V_{out}=2.5V$   
50% to 100% load transients at 12V input and  $T_a=25^\circ C$

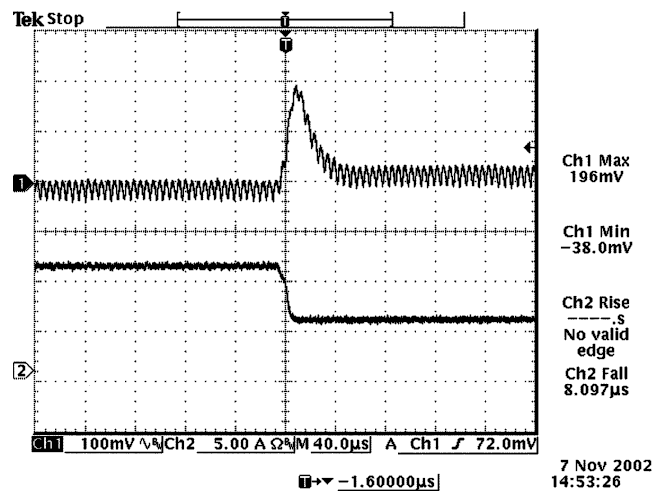

$V_{out}=2.5V$   
100% to 50% load transients at 12V input and  $T_a=25^\circ C$

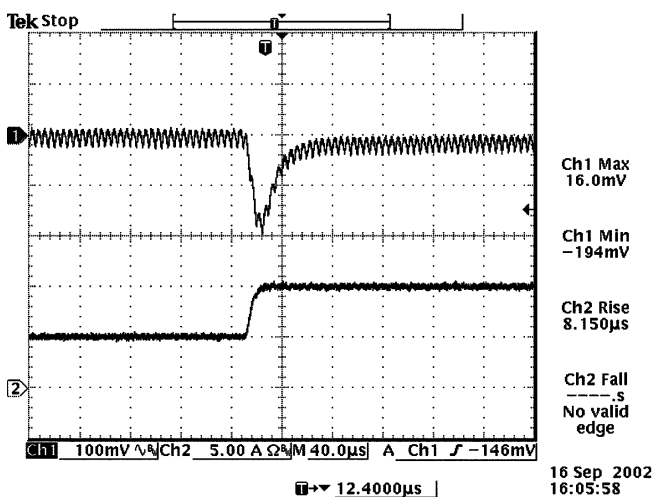

$V_{out}=2.0V$   
50% to 100% load transients at 12V input and  $T_a=25^\circ C$

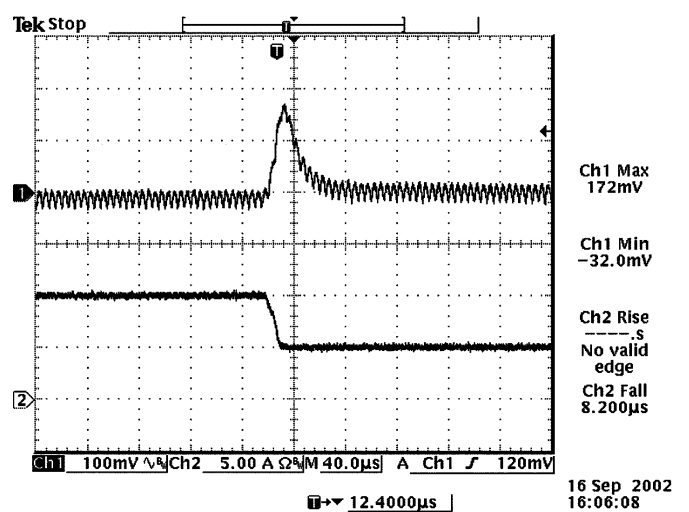

$V_{out}=2.0V$   
100% to 50% load transients at 12V input and  $T_a=25^\circ C$

BP06VRPB-10A

### Transient Response

Transient response:  $di/dt = 0.5A/\mu S$ , external load capacitance  $C_o = 22\mu F$  (Tantalum capacitor)

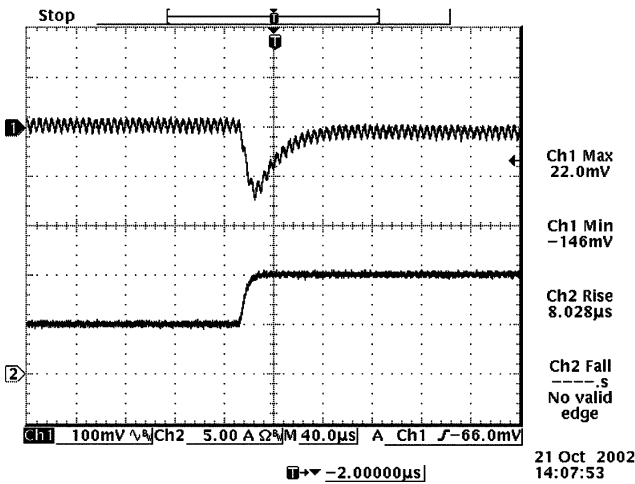

Vout=1.8V  
50% to 100% load transients at 12V input and Ta=25° C

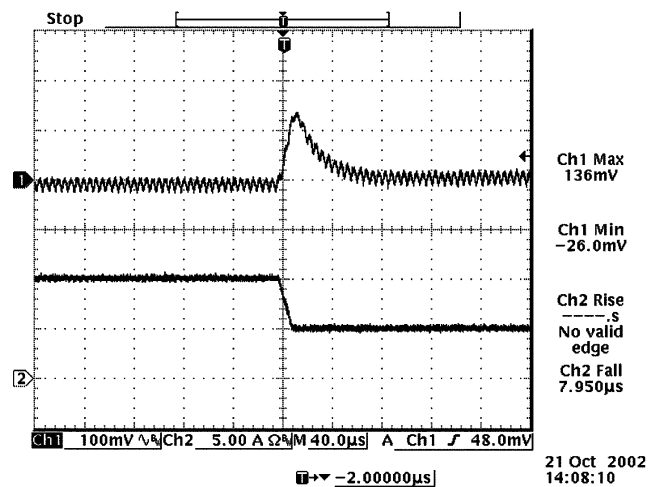

Vout=1.8V  
100% to 50% load transients at 12V input and Ta=25° C

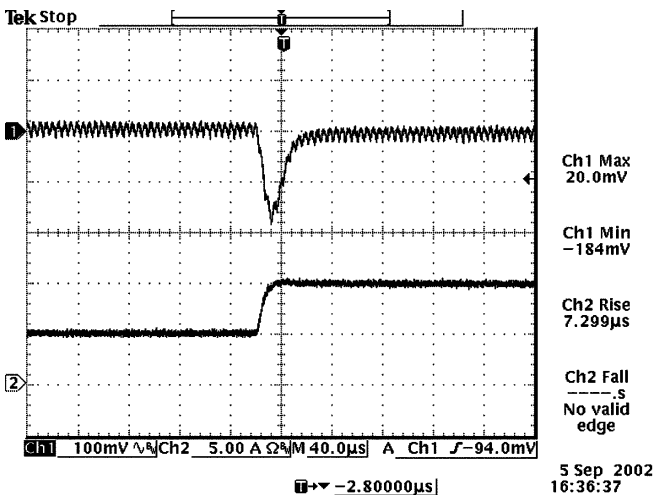

Vout=1.5V  
50% to 100% load transients at 12V input and Ta=25° C

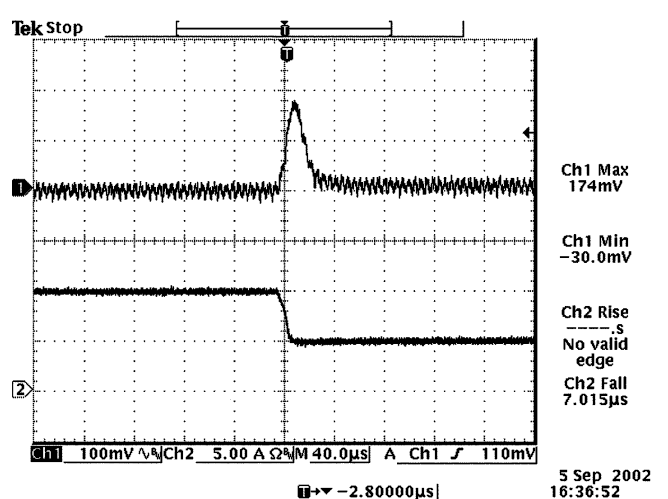

Vout=1.5V  
100% to 50% load transients at 12V input and Ta=25° C

# NON-ISOLATED DC/DC CONVERTERS

## 12V Input / 1.0 – 5.0V Output / 10A



BP06VRPB-10A

### Transient Response

Transient response:  $di/dt = 0.5A/\mu S$ , external load capacitance  $C_o = 22\mu F$  (Tantalum capacitor)

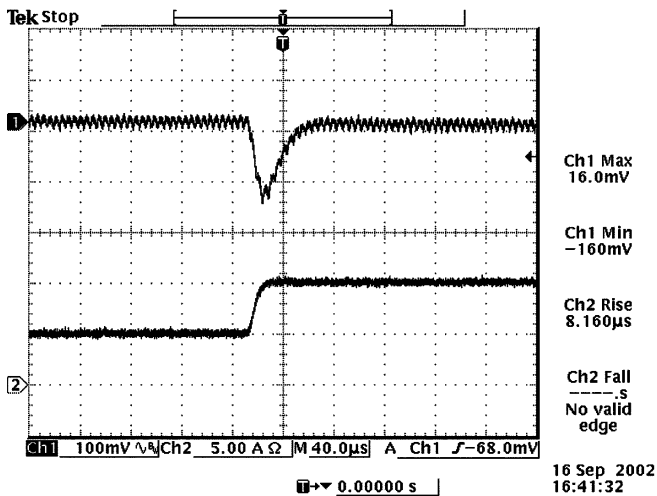

Vout=1.2V  
50% to 100% load transients at 12V input and Ta=25° C

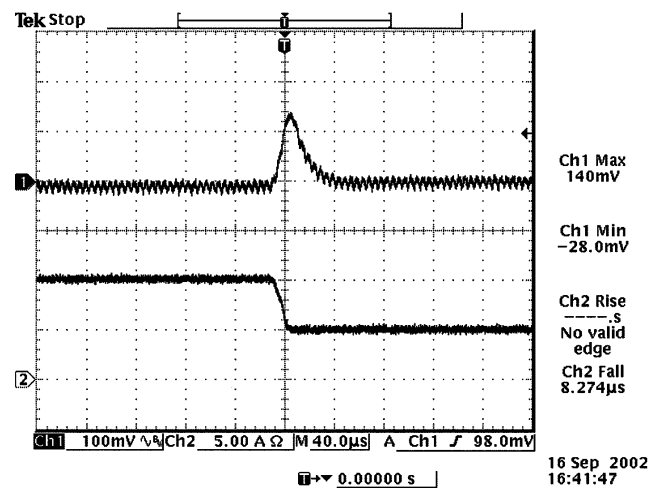

Vout=1.2V  
100% to 50% load transients at 12V input and Ta=25° C

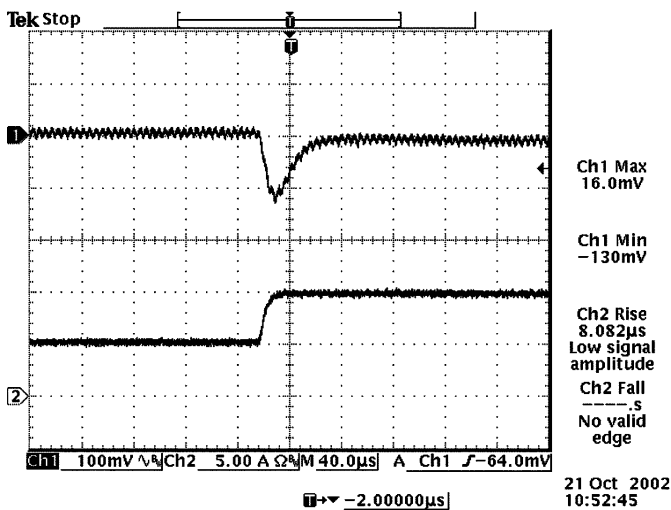

Vout=1.0V  
50% to 100% load transients at 12V input and Ta=25° C

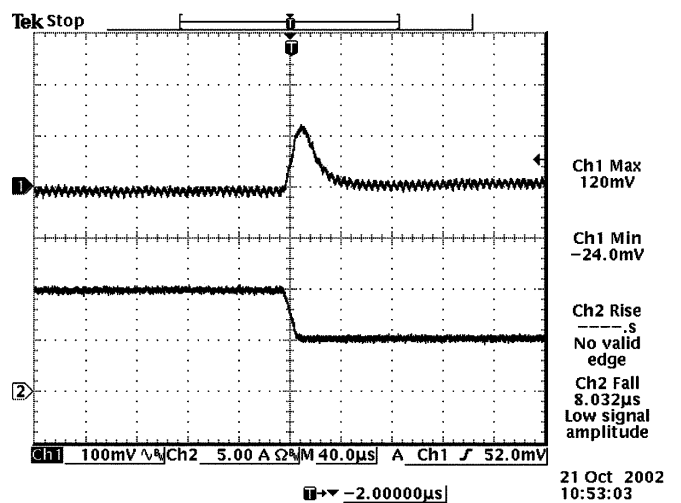

Vout=1.0V  
100% to 50% load transients at 12V input and Ta=25° C

BP06VRPB-10A

### Thermal Considerations

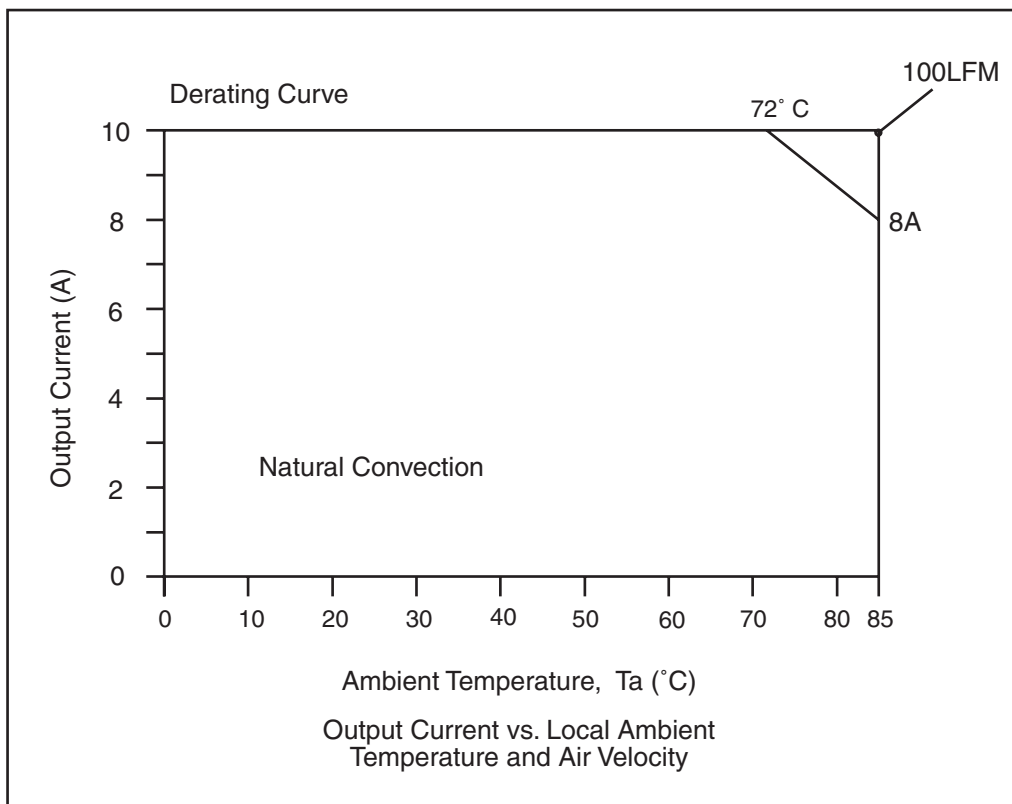

# NON-ISOLATED DC/DC CONVERTERS

12V Input / 1.0 – 5.0V Output / 10A



BP06VRPB-10A

## Output Voltage Set-Point Adjustment

Trim Down Test Circuit

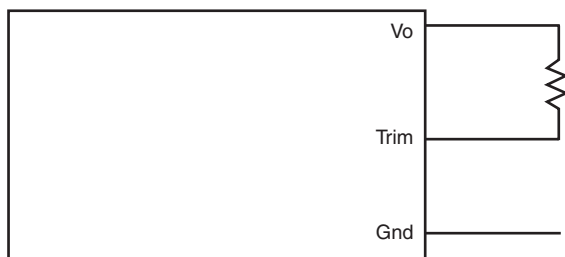

Trim Up Test Circuit

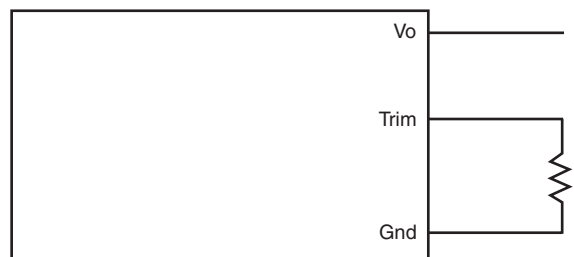

## Output Voltage Set-Point Adjustment

### VRPB-10A50x Trim Resistor Calculation

$$R_{\text{trim down}} = \left( \frac{7.5 (V_o \text{ adj} - 0.8)}{V_o \text{ nom} - V_o \text{ , adj}} - 10 \right) \text{ Kohm}$$

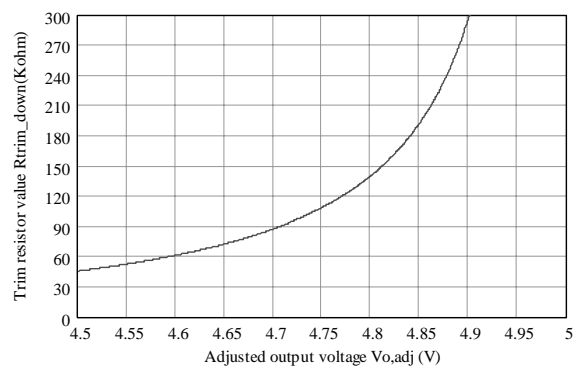

$$R_{\text{trim up}} = \left( \frac{6}{V_o \text{ , adj} - V_o \text{ nom}} - 10 \right) \text{ Kohm}$$

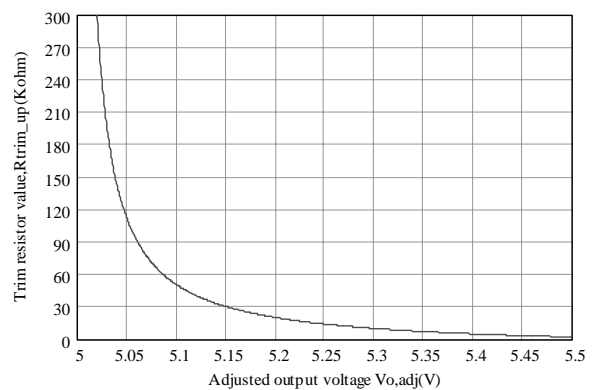

BP06VRPB-10A

### Output Voltage Set-Point Adjustment

#### VRPB-10A33x Trim Resistor Calculation

$$R_{\text{trim down}} = \left( \frac{7.5 (V_o \text{ adj} - 0.8)}{V_o \text{ nom} - V_o \text{ , adj}} - 15 \right) \text{ Kohm}$$

$$R_{\text{trim up}} = \left( \frac{6}{V_o \text{ , adj} - V_o \text{ nom}} - 15 \right) \text{ Kohm}$$

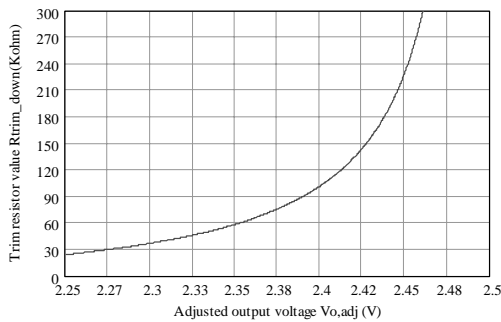
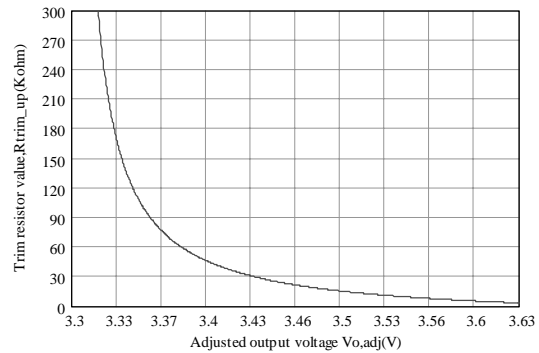
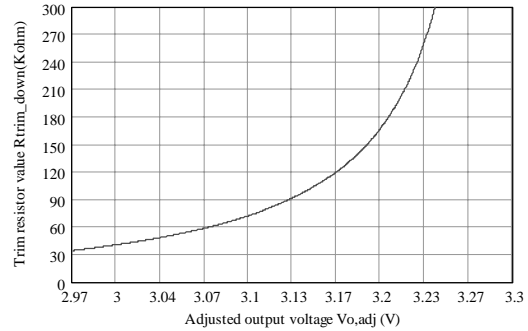

#### VRPB-10A25x Trim Resistor Calculation

$$R_{\text{trim down}} = \left( \frac{7.5 (V_o \text{ adj} - 0.8)}{V_o \text{ nom} - V_o \text{ , adj}} - 20 \right) \text{ Kohm}$$

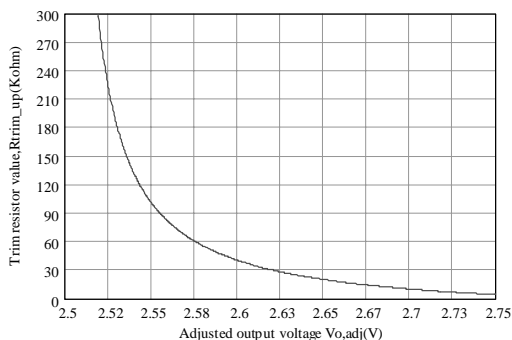

$$R_{\text{trim up}} = \left( \frac{6}{V_o \text{ , adj} - V_o \text{ nom}} - 20 \right) \text{ Kohm}$$

# NON-ISOLATED DC/DC CONVERTERS

## 12V Input / 1.0 – 5.0V Output / 10A



BP06VRPB-10A

### Output Voltage Set-Point Adjustment

#### VRPB-10A20x Trim Resistor Calculation

$$R_{\text{trim down}} = \left( \frac{4.64 (V_o \text{ adj} - 0.8)}{V_o \text{ nom} - V_o \text{ , adj}} - 15.4 \right) \text{ Kohm}$$

$$R_{\text{trim up}} = \left( \frac{3.72}{V_o \text{ , adj} - V_o \text{ nom}} - 15.4 \right) \text{ Kohm}$$

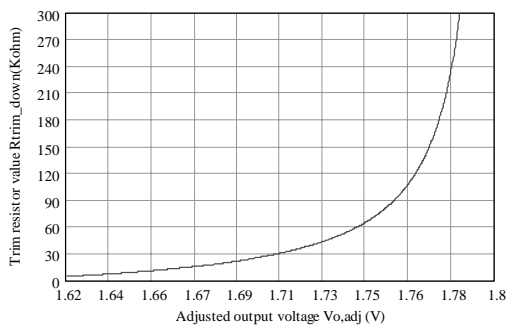
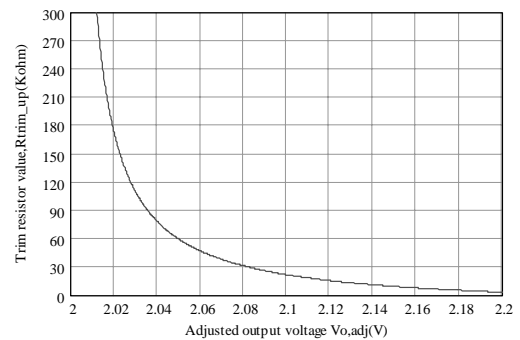
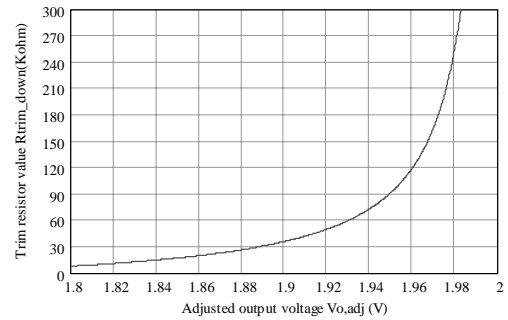

#### VRPB-10A18x Trim Resistor Calculation

$$R_{\text{trim down}} = \left( \frac{4.64 (V_o \text{ adj} - 0.8)}{V_o \text{ nom} - V_o \text{ , adj}} - 16.9 \right) \text{ Kohm}$$

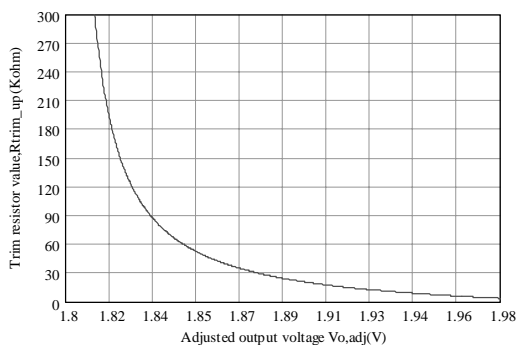

$$R_{\text{trim up}} = \left( \frac{3.72}{V_o \text{ , adj} - V_o \text{ nom}} - 16.9 \right) \text{ Kohm}$$

©2006 Bel Fuse Inc. Specifications subject to change without notice. 02.06

BP06VRPB-10A

### Output Voltage Set-Point Adjustment

#### VRPB-10A15x Trim Resistor Calculation

$$R_{\text{trim down}} = \left( \frac{4.64 (V_o \text{ adj} - 0.8)}{V_o \text{ nom} - V_o, \text{adj}} - 13.3 \right) \text{ Kohm}$$

$$R_{\text{trim up}} = \left( \frac{3.72}{V_o, \text{adj} - V_o \text{ nom}} - 13.3 \right) \text{ Kohm}$$

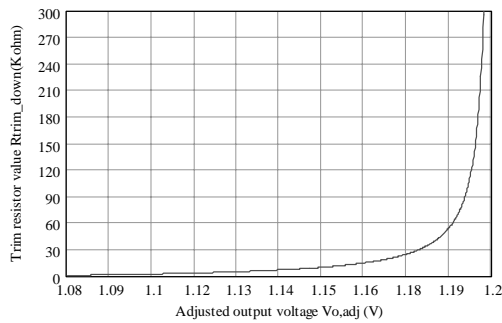
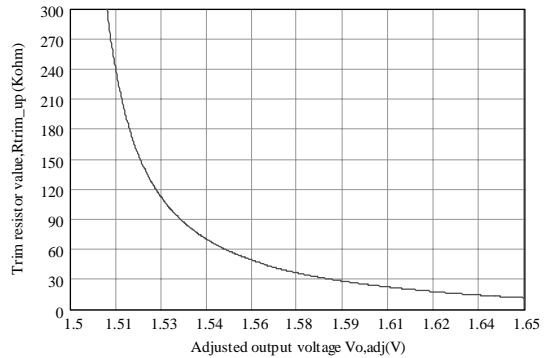
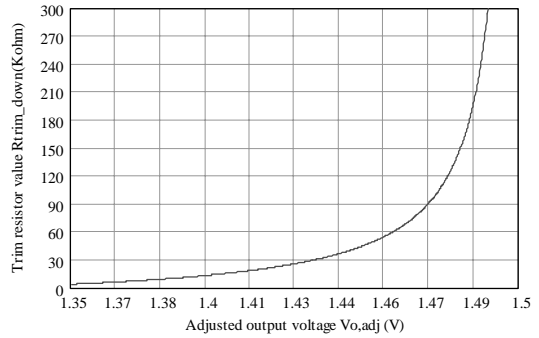

#### VRPB-10A12x Trim Resistor Calculation

$$R_{\text{trim down}} = \left( \frac{1.82 (V_o \text{ adj} - 0.8)}{V_o \text{ nom} - V_o, \text{adj}} - 3.16 \right) \text{ Kohm}$$

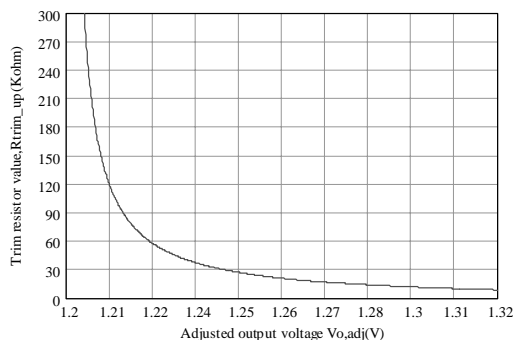

$$R_{\text{trim up}} = \left( \frac{1.46}{V_o, \text{adj} - V_o \text{ nom}} - 3.16 \right) \text{ Kohm}$$

# NON-ISOLATED DC/DC CONVERTERS

12V Input / 1.0 – 5.0V Output / 10A



BP06VRPB-10A

## Output Voltage Set-Point Adjustment

### VRPB-10A10x Trim Resistor Calculation

$$R_{\text{trim down}} = \left( \frac{1.82 (V_o \text{ adj} - 0.8)}{V_o \text{ nom} - V_o \text{ , adj}} - 0.909 \right) \text{ Kohm}$$

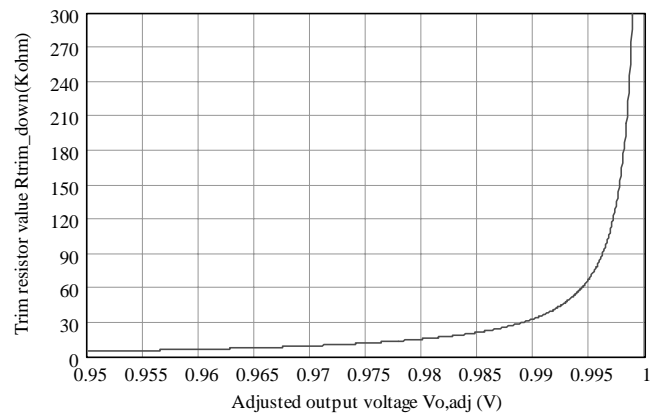

$$R_{\text{trim up}} = \left( \frac{1.46}{V_o \text{ , adj} - V_o \text{ nom}} - 0.909 \right) \text{ Kohm}$$

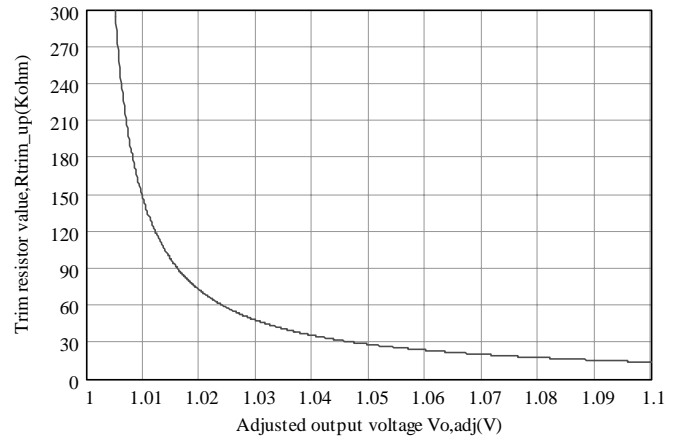

BP06VRPC-10A

### Mechanical

VRPB-10A

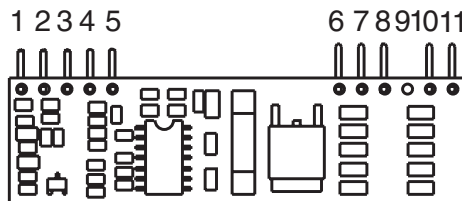
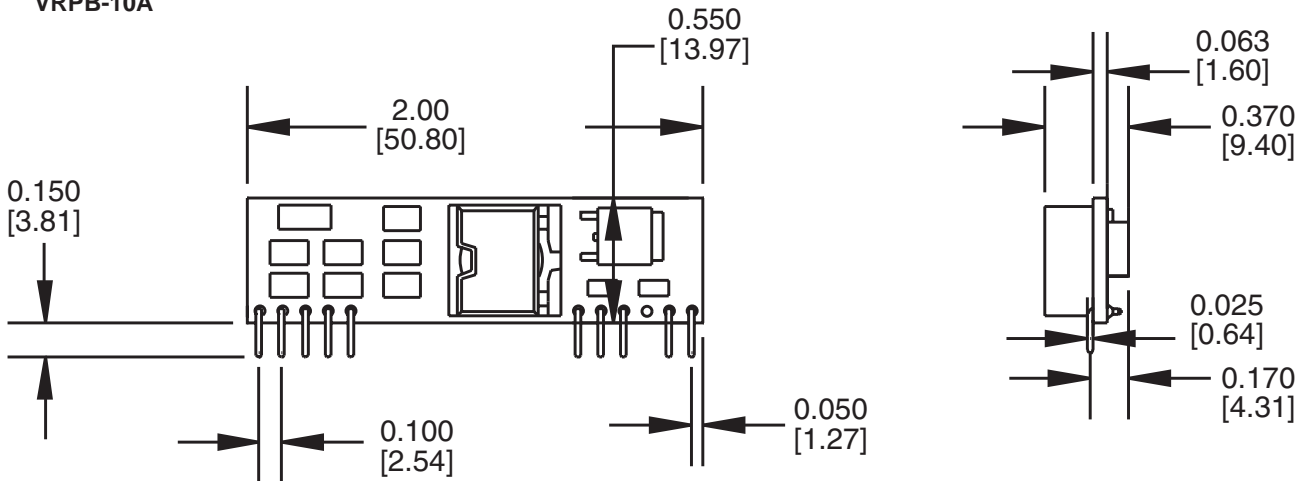

Pin	Function
1	+Vo
2	+Vo
3	Remote Sense
4	+Vo
5	Ground
6	Ground
7	+Vin
8	+Vin
9	No Pin
10	Trim
11	Remote On/Off

#### RoHS Compliance

Complies with the European Directive 2002/95/EC, calling for the elimination of lead and other hazardous substances from electronic products.



©2006 Bel Fuse Inc. Specifications subject to change without notice. 02.06

#### CORPORATE

**Bel Fuse Inc.**  
206 Van Vorst Street  
Jersey City, NJ 07302  
Tel 201-432-0463  
Fax 201-432-9542  
www.belfuse.com

page 22

#### FAR EAST

**Bel Fuse Ltd.**  
8F / 8 Luk Hop Street  
San Po Kong  
Kowloon, Hong Kong  
Tel 852-2328-5515  
Fax 852-2352-3706  
www.belfuse.com

#### EUROPE

**Bel Fuse Europe Ltd.**  
Preston Technology Management Centre  
Marsh Lane, Suite G7, Preston  
Lancashire, PR1 8UD, U.K.  
Tel 44-1772-556601  
Fax 44-1772-888366  
www.belfuse.com