

1000 WATT FXP SERIES DC/DC CONVERTERS



Description

The 4:1 Input Voltage 1000 Watt Single FXP DC/DC converter provides a regulated dc output with capability for paralleling up to three converters delivering up to 2.8kW. Current sharing among converters is achieved using droop method and does not require a current share pin. The output voltage is fully isolated from the input, allowing the output to be positive or negative polarity and with various ground connections. The 1000 Watt FXP meets the most rigorous performance standards in an industry standard footprint for mobile (12V_{in}), process control (24V_{in}), and military COTS (28V_{in}) applications.

The 4:1 Input Voltage 1000W FXP includes trim and remote ON/OFF. Threaded through holes are provided to allow easy mounting or addition of a heatsink for extended temperature operation.

The converters high efficiency and high power density are accomplished through use of high-efficiency synchronous rectification technology, advanced electronic circuit, packaging and thermal design thus resulting in a high reliability product. Converter operates at a fixed frequency and follows conservative component de-rating guidelines.

Product is designed and manufactured in the USA.

Features

- 4:1 Input voltage range
- High power density
- Parallel Operation - up to 3 units (2.8kW)
- Small size 2.5" x 4.7" x 0.52"
- Efficiency up to 96%
- Excellent thermal performance with metal case
- Over-Current and Short Circuit Protection
- Over-Temperature protection
- Auto-restart
- Monotonic startup into pre bias
- Constant frequency
- Remote ON/OFF
- Good shock and vibration damping
- Temperature Range -40°C to +105°C Available.
- RoHS Compliant

Model	Input Range VDC		Vout VDC	Iout ADC
	Min	Max		
24S24.42FXP (ROHS)	9	36	24	42
24S28.36FXP (ROHS)	9	36	28	36
24S48.21FXP (ROHS)	9	36	48	21
24S53.19FXP (ROHS)	9	36	53	19

1. **Negative Logic ON/OFF feature available. Add "-N" to the part number when ordering. i.e. 24S24.42FXP-N (ROHS)**

2. **Designed to meet MIL-STD-810G for functional shock and vibration. The unit must be properly secured to the interface medium (PCB/Chassis) by use of the threaded inserts of the unit.**

3. **A thermal management device, such as a heatsink, is required to ensure proper operation of this device. The thermal management medium is required to maintain baseplate < 105°C for full rated power.**

4. **Non-Standard output voltages are available. Please contact the factory for additional information.**

1000 WATT FXP SERIES DC/DC CONVERTERS



Electrical Specifications

Conditions: $T_A = 25\text{ }^\circ\text{C}$, Airflow = 300 LFM (1.5 m/s), $V_{in} = 24\text{VDC}$, unless otherwise specified. Specifications are subject to change without notice.

All Models					
Parameter	Notes	Min	Typ	Max	Units
Absolute Maximum Ratings					
Input Voltage	Continuous	0		40	V
	Transient (100ms)			50	V
Operating Temperature	Baseplate (100% load)	-40		105	$^\circ\text{C}$
Storage Temperature		-55		125	$^\circ\text{C}$
Isolation Characteristics and Safety					
Isolation Voltage	Input to Output	2250			V
	Input to Baseplate & Output to Baseplate	1500			V
Isolation Capacitance			9000		pF
Isolation Resistance		10	20		$\text{M}\Omega$
Insulation Safety Rating			Basic		
Designed to meet UL/cUL 60950, IEC/EN60950-1					
Feature Characteristics					
Fixed Switching Frequency			200		kHz
	Input Current and Output Voltage Ripple		400		kHz
Output Voltage Trim Range	Adjustable via TRIM (Pin 12)	60		110	%
Remote Sense Compensation	Between SENSE+ and +OUT pins			1	V
Output Overvoltage Protection	Non-latching	114	122	130	%
Overtemperature Shutdown (Baseplate)	Non-latching ($V_{in}=9\text{V}$; 12V, 24/36V)	108	112	115	$^\circ\text{C}$
Auto-Restart Period	Applies to all protection features	1.7	2	2.3	s
Turn-On Delay Time from V_{in}	Time from UVLO to $V_o=90\%V_{OUT}(\text{NOM})$ Resistive load	480	517	530	ms
Turn-On Delay Time from ON/OFF Control (From ON to 90% $V_{OUT}(\text{NOM})$ Resistive load)	24S24.42FXP & 24S28.36FXP	20	27	35	ms
	24S48.21FXP & 24S53.19FXP	20	35	50	ms
Rise Time (V_{out} from 10% to 90%)	24S24.42FXP & 24S28.36FXP	4	7	11	ms
	24S48.21FXP & 24S53.19FXP	7	15	25	ms
ON/OFF Control – Positive Logic					
ON state	Pin open = ON or	2		12	V
Control Current	Leakage current			0.16	mA
OFF state		0		0.8	V
Control current	Sinking	0.3		0.36	mA
ON/OFF Control – Negative Logic					
ON state	Pin shorted to – ON/OFF pin or	0		0.8	V
OFF state	Pin open = OFF or	2		12	V
Thermal Characteristics					
Thermal resistance Baseplate to Ambient	Converter soldered to 5" x 3.5" x 0.07", 4 layers/ 2Oz copper FR4 PCB.		3.3		$^\circ\text{C/W}$

1000 WATT FXP SERIES DC/DC CONVERTERS



Electrical Specifications (Continued):

Conditions: $T_A = 25\text{ }^\circ\text{C}$, Airflow = 300 LFM (1.5 m/s), $V_{in} = 24\text{VDC}$, unless otherwise specified. Specifications are subject to change without notice.

24S24.42FXP						
Parameter	Notes	Min	Typ	Max	Units	
Input Characteristics						
Operating Input Voltage Range		9	24	36	V	
Input Under Voltage Lockout	Non-latching					
Turn-on Threshold		8.2	8.5	8.8	V	
Turn-off Threshold		7.7	8.0	8.3	V	
Lockout Hysteresis Voltage		0.4	0.55	0.7	V	
Maximum Input Current	$V_{in} = 9\text{V}$, 80% Load			89	A	
	$V_{in} = 12\text{V}$, 100% Load			92	A	
	$V_{in} = 24\text{V}$, Output Shorted		350		mARMS	
Input Stand-by Current	Converter Disabled		3	4	mA	
Input Current @ No Load	Converter Enabled	330	420	500	mA	
Minimum Input Capacitance (external) ¹⁾	ESR < 0.1 Ω	1000			μF	
Inrush Transient				0.19	A^2s	
Input Terminal Ripple Current, i_c ²⁾	20 MHz bandwidth, 100% Load (Fig.24)		1.6		ARMS	
Output Characteristics						
Output Voltage Range	Over Load, Line and temperature	23.549		24.301	V	
Output Voltage Set Point Accuracy	(No load)	24.179	24.240	24.301	V	
Output Regulation						
Over Line	$V_{in} = 9\text{V}$ to 36V		0.05	0.10	%	
Over Load	$V_{in} = 24\text{V}$, Load 0% to 100%	2.37	2.5	2.63	%	
Temperature Coefficient			0.005	0.015	%/ $^\circ\text{C}$	
Overvoltage Protection		27.4		31.2	V	
Output Ripple and Noise 20 MHz bandwidth	See Fig. 6 and Table 1 for details. Full load, 20 MHz bandwidth.		60	120	mV _{PK-PK}	
			15	35	mV _{RMS}	
External Load Capacitance ^{1), 2)}	Full Load (resistive) (over operating temp range)	C_{EXT} ESR	1000		4700	μF
			10		100	m Ω
Output Current Range (See Fig. A)	$V_{in} = 12\text{V} - 36\text{V}$	0		42	A	
	$V_{in} = 9\text{V}$	0		33.6	A	
Current Limit Inception	$V_{in} = 12\text{V} - 36\text{V}$	46.2	50.2	54.6	A	
	$9\text{V} \leq V_{in} < 12\text{V}$	37	49	54.6	A	
RMS Short-Circuit Current	Non-latching, Continuous		2.7	5	A _{RMS}	
Dynamic Response²⁾						
Load Change 50%-75%-50%, $di/dt = 1\text{A}/\mu\text{s}$	See Fig. 21 and Table 1 for C_{EXT} .		560	800	mV _{P-P}	
Load Change 50%-100%-50%, $di/dt = 1\text{A}/\mu\text{s}$	See Fig 22 and Table 1 for C_{EXT} .		1100	1600	mV _{P-P}	
Settling Time to 1% of V_{OUT}			700		μs	
Efficiency						
100% Load	$V_{in} = 24\text{V}$	93.6	94.6	95.3	%	
	$V_{in} = 12\text{V}$	92.4	93.4	94.1	%	
50% Load	$V_{in} = 24\text{V}$	94.8	95.6	96.4	%	
	$V_{in} = 12\text{V}$	94.7	95.4	96.3	%	

¹⁾ Section "Input and Output Capacitance" and Table 1 (Section "Test Configuration")

²⁾ See Section "Test Configuration" for details. Output voltage deviation is measured peak to peak (includes switching ripple and voltage droop).



1000 WATT FXP SERIES DC/DC CONVERTERS



Electrical Specifications (Continued):

Conditions: $T_A = 25^\circ\text{C}$, Airflow = 300 LFM (1.5 m/s), $V_{in} = 24\text{VDC}$, unless otherwise specified. Specifications are subject to change without notice.

24S28.36FXP					
Parameter	Notes	Min	Typ	Max	Units
Operating Input Voltage Range		9	24	36	V
Input Under Voltage Lockout	Non-latching				
Turn-on Threshold		8.2	8.5	8.8	V
Turn-off Threshold		7.7	8.0	8.3	V
Lockout Hysteresis Voltage		0.4	0.55	0.7	V
Maximum Input Current	$V_{in} = 9\text{V}$, 80% Load			89	A
	$V_{in} = 12\text{V}$, 100% Load			92	A
	$V_{in} = 24\text{V}$, Output Shorted		330		mA_{RMS}
Input Stand-by Current	Converter Disabled		3	4	mA
Input Current @ No Load	Converter Enabled	400	460	560	mA
Minimum Input Capacitance (external) ¹⁾	ESR < 0.1 Ω	1000			μF
Inrush Transient				0.19	A^2_{s}
Input Reflected Ripple Current, i_c ²⁾	20 MHz bandwidth, 100% Load (Fig. 26)		1.3		A_{RMS}
Output Characteristics					
Nominal Output Voltage	Over Load, Line and temperature	27.463		28.347	V
Output Voltage Set Point Accuracy	(No load)	28.205	28.276	28.347	V
Output Regulation					
Over Line	$V_{in} = 9\text{V}$ to 36V		0.05	0.1	%
Over Load	$V_{in} = 24\text{V}$, Load 0% to 100%	2.37	2.5	2.63	%
Temperature Coefficient			0.005	0.015	%/ $^\circ\text{C}$
Overvoltage Protection		31.9		36.4	V
Output Ripple and Noise	See Fig. 6 and Table 1 for details. Full load 20 MHz bandwidth.		50	100	$\text{mV}_{\text{PK-PK}}$
			12	25	mV_{RMS}
External Load Capacitance ^{1),2)}	Full Load (resistive) (over operating temp range)	C_{EXT}	1000	4700	μF
		ESR	10	100	$\text{m}\Omega$
Output Current Range (See Fig. A)	$V_{in} = 12\text{V} - 36\text{V}$	0		36	A
	$V_{in} = 9\text{V}$	0		28.8	A
Current Limit Inception	$V_{in} = 12\text{V} - 36\text{V}$	39.6		46.8	A
	$9\text{V} \leq V_{in} < 12\text{V}$	31.7		46.8	A
RMS Short-Circuit Current	Non-latching		1.8	2.5	A_{RMS}
Dynamic Response					
Load Change 50%-75%-50%, $di/dt = 1\text{A}/\mu\text{s}$	See Fig. 27 and Table 1 for C_{EXT} .		500	720	mV
Load Change 50%-100%-50%, $di/dt = 1\text{A}/\mu\text{s}$	See Fig. 28 and Table 1 for C_{EXT} .		1000	1500	mV
Settling Time to 1% of V_{OUT}			700		μs
Efficiency					
100% Load	$V_{in} = 24\text{V}$	94.8	95.6	96.3	%
	$V_{in} = 12\text{V}$	93.0	93.8	94.5	%
50% Load	$V_{in} = 24\text{V}$	95.6	96.4	97.1	%
	$V_{in} = 12\text{V}$	94.3	95.4	96.2	%

¹⁾ Section "Input and Output Capacitance" and Table 1 (Section "Test Configuration")

²⁾ See Section "Test Configuration" for details. Output voltage deviation is measured peak to peak (includes switching ripple and voltage droop).

1000 WATT FXP SERIES DC/DC CONVERTERS



Electrical Specifications (Continued): Conditions: $T_A = 25\text{ }^\circ\text{C}$, Airflow = 300 LFM (1.5 m/s), $V_{in} = 24\text{VDC}$, unless otherwise specified. Specifications are subject to change without notice.

24S48.21FXP					
Parameter	Notes	Min	Typ	Max	Units
Input Characteristics					
Operating Input Voltage Range		9	24	36	V
Input Under Voltage Lockout	Non-latching				
Turn-on Threshold		8.2	8.5	8.8	V
Turn-off Threshold		7.7	8.0	8.3	V
Lockout Hysteresis Voltage		0.4	0.55	0.7	V
Maximum Input Current	$V_{in} = 9\text{V}$, 80% Load			89	A
	$V_{in} = 12\text{V}$, 100% Load			92	A
	$V_{in} = 24\text{V}$, Output Shorted		350		mARMS
Input Stand-by Current	Converter Disabled		3	4	mA
Input Current @ No Load	Converter Enabled	360	460	550	mA
Minimum Input Capacitance (external) ¹⁾	ESR < 0.1 Ω	1000			μF
Inrush Transient				0.19	A^2s
Input Terminal Ripple Current, i_c ²⁾	20 MHz bandwidth, 100% Load (Fig. 36)		1.6		ARMS
Output Characteristics					
Output Voltage Range	Over Load, Line and temperature	47.086		48.601	V
Output Voltage Set Point Accuracy	(No load)	48.359	48.480	48.601	V
Output Regulation					
Over Line	$V_{in} = 9\text{V}$ to 36V		0.05	0.10	%
Over Load	$V_{in} = 24\text{V}$, Load 0% to 100%	2.37	2.5	2.63	%
Temperature Coefficient			0.005	0.015	%/ $^\circ\text{C}$
Overvoltage Protection		54.7		62.4	V
Output Ripple and Noise	See Fig. 6 and Table 1 for details. Full load 20 MHz bandwidth.		100	240	mV _{PK-PK}
			30	80	mV _{RMS}
External Load Capacitance ^{1), 2)}	Full Load (resistive) (over operating temp range)	C_{EXT}	470	3000	μF
		ESR	10	100	m Ω
Output Current Range (See Fig. A)	$V_{in} = 12\text{V} - 36\text{V}$	0		21	A
	$V_{in} = 9\text{V}$	0		16.8	A
Current Limit Inception	$V_{in} = 12\text{V} - 36\text{V}$	23.1	25.2	27.3	A
	$9\text{V} \leq V_{in} < 12\text{V}$	18.5	24.2	27.3	A
RMS Short-Circuit Current	Non-latching, Continuous		1.4	2.4	A _{RMS}
Dynamic Response²⁾					
Load Change 50%-75%-50%, di/dt = 1A/ μs	See Fig. 33.		660	950	mV _{P-P}
Load Change 50%-100%-50%, di/dt = 1A/ μs	See Fig. 34.		1320	1900	mV _{P-P}
Settling Time to 1% of V _{OUT}			600		μs
Efficiency					
100% Load	$V_{in} = 24\text{V}$	94.3	95	95.7	%
	$V_{in} = 12\text{V}$	93.2	93.9	94.6	%
50% Load	$V_{in} = 24\text{V}$	95.3	96	96.7	%
	$V_{in} = 12\text{V}$	95.1	95.8	96.5	%

¹⁾ Section "Input and Output Capacitance" and Table 1 (Section "Test Configuration")

²⁾ See Section "Test Configuration" for details. Output voltage deviation is measured peak to peak (includes switching ripple and voltage droop).

1000 WATT FXP SERIES DC/DC CONVERTERS



Electrical Specifications (Continued):

Conditions: $T_A = 25^\circ\text{C}$, Airflow = 300 LFM (1.5 m/s), $V_{in} = 24\text{VDC}$, unless otherwise specified. Specifications are subject to change without notice.

24S53.19FXP					
Parameter	Notes	Min	Typ	Max	Units
Operating Input Voltage Range		9	24	36	V
Input Under Voltage Lockout	Non-latching				
Turn-on Threshold		8.2	8.5	8.8	V
Turn-off Threshold		7.7	8.0	8.3	V
Lockout Hysteresis Voltage		0.4	0.55	0.7	V
Maximum Input Current	$V_{in} = 9\text{V}$, 80% Load			89	A
	$V_{in} = 12\text{V}$, 100% Load			92	A
	$V_{in} = 24\text{V}$, Output Shorted		330		mA_{RMS}
Input Stand-by Current	Converter Disabled		2	4	mA
Input Current @ No Load	Converter Enabled	400	460	560	mA
Minimum Input Capacitance (external) ¹⁾	ESR < 0.1 Ω	1000			μF
Inrush Transient				0.19	A^2_{s}
Input Reflected-Ripple Current, i_c	25 MHz bandwidth, 100% Load (Fig. 6)		1.2		A_{RMS}
Output Characteristics					
Nominal Output Voltage	Over Load, Line and temperature	51.991		53.664	V
Output Voltage Set Point Accuracy	(No load)	53.396	53.530	53.664	V
Output Regulation					
Over Line	$V_{in} = 9\text{V}$ to 36V		0.05	0.1	%
Over Load	$V_{in} = 24\text{V}$, Load 0% to 100%	2.37	2.5	2.63	%
Temperature Coefficient			0.005	0.015	%/ $^\circ\text{C}$
Overvoltage Protection		60.4		68.9	V
Output Ripple and Noise	See Fig. 6 and Table 1 for details. Full load 20 MHz bandwidth		100	240	$\text{mV}_{\text{PK-PK}}$
			30	80	mV_{RMS}
External Load Capacitance ¹⁾	Full Load (resistive) (over operating temp range) CEXT ESR	470		2200	μF
		10		100	$\text{m}\Omega$
Output Current Range (See Fig. A)	$V_{in} = 12\text{V} - 36\text{V}$	0		19	A
	$V_{in} = 9\text{V}$	0		15.2	A
Current Limit Inception	$V_{in} = 12\text{V} - 36\text{V}$	20.9	22.8	24.7	A
	$9\text{V} \leq V_{in} < 12\text{V}$	16.7	20	24.7	A
RMS Short-Circuit Current	Non-latching		1	2	A_{RMS}
Dynamic Response²⁾					
Load Change 50%-75%-50%, $di/dt = 1\text{A}/\mu\text{s}$	See Fig. 39.		550	800	$\text{mV}_{\text{P-P}}$
Load Change 50%-100%-50%, $di/dt = 1\text{A}/\mu\text{s}$	See Fig. 40.		1100	1600	$\text{mV}_{\text{P-P}}$
Settling Time to 1% of V_{OUT}			600		μs
Efficiency					
100% Load	$V_{in} = 24\text{V}$	94.7	95.5	96.2	%
	$V_{in} = 12\text{V}$	93.3	94	94.8	%
50% Load	$V_{in} = 24\text{V}$	95.5	96.2	97	%
	$V_{in} = 12\text{V}$	94.8	95.5	96.2	%

¹⁾ Section "Input and Output Capacitance" and Table 1 (Section "Test Configuration").

²⁾ See Section "Test Configuration" for details. Output voltage deviation is measured peak to peak (includes switching ripple and voltage droop).

1000 WATT FXP SERIES DC/DC CONVERTERS



Environmental and Mechanical Specifications. Specifications are subject to change without notice.

Parameter	Note	Min	Typ	Max	Units
Environmental					
Operating Humidity	Non-condensing			95	%
Storage Humidity	Non-condensing			95	%
ROHS Compliance ¹	See Calex Website http://www.calex.com/RoHS.html for the complete RoHS Compliance statement				
Shock and Vibration	Designed to meet MIL-STD-810G for functional shock and vibration.				
Water washability	Not recommended for water wash process. Contact the factory for more information.				
Mechanical					
Weight			8.55		Ounces
			242		Grams
Through Hole Pins Diameter	Pins 3, 3A, 4, 4A, 5, 6, 8 and 9	0.079	0.081	0.083	Inches
		2.006	2.057	2.108	mm
	Pins 1, 2, 10, 11 and 12	0.038	0.04	0.042	Inches
		0.965	1.016	1.667	mm
Through Hole Pins Material	Pins 3, 3A, 4, 4A, 5, 6, 8 and 9	C14500 or C1100 Copper Alloy			
	Pins 1, 2, 10, 11 and 12	Brass Alloy TB3 or "Eco Brass"			
Through Hole Pin Finish	All pins	10µ" Gold over nickel			
Case Dimension		4.7 x 2.5 x 0.52			Inches
		119.38 x 63.50 x 13.21			mm
Case Material	Plastic: Vectra LCP FIT30: ½-16 EDM Finish				
Baseplate	Material	Aluminum			
	Flatness		0.010		Inches
			0.25		mm
Reliability					
MTBF	Telcordia SR-332, Method I Case 1 50% electrical stress, 40°C components		5.4		MHrs
EMI and Regulatory Compliance					
Conducted Emissions	MIL-STD 461F CE102 with external EMI filter network (See Figs. 39-41)				

Additional Notes:

¹ The RoHS marking is as follows

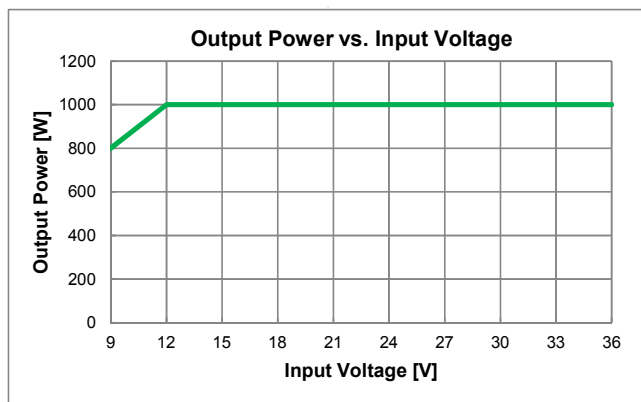

Figure A: Output Power as function of input voltage.



2401 Stanwell Drive, Concord Ca. 94520

Ph: 925-687-4411

Fax: 925-687-3333

www.calex.com

Email: sales@calex.com

1000 WATT FXP SERIES DC/DC CONVERTERS



Operations

Input Fusing

The FXP converters do not provide internal fusing and therefore in some applications external input fuse may be required. Use of external fuse is also recommended if there is possibility for input voltage reversal. For greatest safety, it is recommended to use fast blow fuse in the ungrounded input supply line.

Input Reverse Polarity Protection

The FXP converters do not have input reverse polarity. If input voltage polarity is reversed, internal diodes will become forward biased and draw excessive current from the power source. If the power source is not current limited or input fuse not used, the converter could be permanently damaged.

Input Undervoltage Protection

Input undervoltage lockout is standard with this converter. The FXP converter will start and regulate properly if the ramping-up input voltage exceeds Turn-on threshold of typ. 8.5V (See Specification) and remains at or above Turn-on Threshold.

The converter will turn off when the input voltage drops below the Turn-off Threshold of typical 8V (See specification) and converter enters hiccup mode and will stay off for 2 seconds. The converter will restart after 2 seconds only if the input voltage is again above the Turn-on Threshold.

The built-in hysteresis and 2 second hiccup time prevents any unstable on/off operation at the low input voltage near Turn-on Threshold.

User should take into account for IR and inductive voltage drop in the input source and input power lines and make sure that the input voltage to the converter is always above the Turn-off Threshold voltage under ALL OPERATING CONDITIONS.

Start-Up Time

The start-up time is specified under two different scenarios: a) Startup by ON/OFF remote control (with the input voltage above the Turn-on Threshold voltage) and b) Start-up by applying the input voltage (with the converter enabled via ON/OFF remote control).

The startup times are measured with maximum resistive load as: a) the interval between the point when the ramping input voltage crosses the Turn-on Threshold and the output voltage reaches 90% of its nominal value and b) the interval between the point when the converter is enabled by ON/OFF remote control and time when the output voltage reaches 90% of its nominal value.

When converter is started by applying the input voltage with ON/OFF pin active there is delay of 500msec that was intentionally provided to prevent potential startup issues especially at low input voltages

Input Source Impedance

Because of the switching nature and negative input impedance of DC/DC converters, the input of these converters must be driven from the source with both low AC impedance and DC input regulation.

The FXP converters are designed to operate without external components as long as the source voltage has very low impedance and reasonable voltage regulation. However, since this is not the case in most applications an additional input capacitor is required to provide proper operations of the FXP converter. Specified values for input capacitor are recommendation and need to be adjusted for particular application. Due to large variation between applications some experimentation may be needed.

In many applications, the inductance associated with the distribution from the power source to the input of the converter can affect the stability and in some cases, if excessive, even inhibit operation of the converter. This becomes of great consideration for input voltage at 12V or below.

The DC input regulation, associated with resistance between input power source and input of the converter, plays significant role in particular in low input voltage applications such as 12V battery systems.

Note that input voltage at the input pins of the connector must never degrade below Turn-off threshold under all load operating conditions.

Note that in applications with high pulsating loads additional input as well as output capacitors may be needed. In addition, for EMI conducted measurement, due to low input voltage it is recommended to use 5 μ H LISNs instead of typical 50 μ H LISNs.

Input/ Output Filtering

Input Capacitor

Minimum required input capacitance, mounted close to the input pins of the converter, is 1000 μ F with ESR < 0.1 Ω .

Several criteria need to be met when choosing input capacitor: a) type of capacitor, b) capacitance to provide additional energy storage, c) RMS current rating, d) ESR value that will ensure that output impedance of the input filter is lower than input impedance of the converter and its variation over the temperature.

Since inductance of the input power cables could have significant voltage drop due to rate of change of input current $di(in)/dt$ during transient load operation, an external capacitor on the output of the converter is also



1000 WATT FXP SERIES DC/DC CONVERTERS



required to reduce $di(in)/dt$. Another constraint is minimum rms current rating of the input capacitors which is application dependent. One component of input rms current is high frequency component at switching frequency of the converter (typ. 400kHz) and is specified under "Input terminal ripple current" i_c . Typical values at full rated load and 24 Vin are provided in Section "Characteristic Waveforms" for each model. It is recommended to use ceramic capacitors for attenuating this component of input terminal ripple current, which is also required to meet requirement for conducted EMI (See EMI Section). The second component of the input ripple current is due to pulsating load current being reflected to the input. An electrolytic capacitors, usually used for this purpose, need to be selected accordingly. ESR of the electrolytic capacitors, need to be carefully chosen taken into account temperature dependence.

Output Capacitor

Similar considerations apply for selecting external output capacitor. For additional high frequency noise attenuation use of ceramic capacitors or very low ESR electrolytic capacitors is recommended while in order to provide stability of the converter during high pulsating loads high value electrolytic capacitor is required. It is recommended to use several electrolytic capacitors in parallel in order to reduce effective ESR and support required RMS pulsating load current. ESR temperature dependence needs to be taken into account.

Recommended output capacitors for various models, used for obtaining characteristic waveforms are given in Table 1 ("Test Configuration" section).

ON/OFF (Pins 1 and 2)

The ON/OFF pin is used to turn the power converter on or off remotely via a system signal and has positive logic. A typical connection for remote ON/OFF function is shown in Fig. 1.

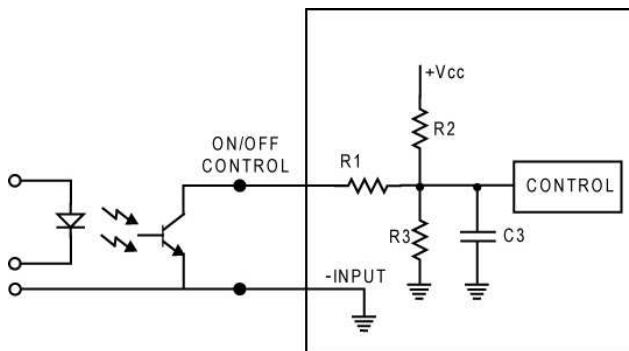

Fig. 1: Circuit configuration for ON/OFF function.

The positive logic version turns on when the +ON/OFF pin is at logic high and turns off when at logic low. The converter is on when the +ON/OFF pin is either left open or external voltage greater than 2V and not more than

12V is applied between +ON/OFF pin –ON/OFF pin. See the Electrical Specifications for logic high/low definitions.

The negative logic version turns on when the +ON/OFF pin is at logic low and turns off when at logic high. The converter is on when the +ON/OFF pin is either shorted to –ON/OFF pin or kept below 0.8V. The converter is off when the +ON/OFF pin is either left open or external voltage not more than 12V is applied between +ON/OFF pin and –ON/OFF pin. See the Electrical Specifications for logic high/low definitions.

The +ON/OFF pin is internally pulled up to typically 4.5V via resistor and connected to internal logic circuit via RC circuit in order to filter out noise that may occur on the ON/OFF pin. The -ON/OFF pin is internally connected to –INPUT. A properly de-bounced mechanical switch, open-collector transistor, or FET can be used to drive the input of the +ON/OFF pin. The device must be capable of sinking up to 0.36mA at a low level voltage of $\leq 0.8V$. During logic high, the typical maximum voltage at ON/OFF pin (generated by the converter) is 4.5V, and the maximum allowable leakage current is 160 μ A. If not using the remote on/off feature leave the +ON/OFF pin open.

TTL Logic Level - The range between 0.81V and 2V is considered the dead-band. Operation in the dead-band is not recommended.

External voltage for ON/OFF control should not be applied when there is no input power voltage applied to the converter.

Output Overcurrent Protection (OCP)

The converter is protected against overcurrent or short circuit conditions. Upon sensing an overcurrent condition, the converter will switch to constant current operation and thereby begin to reduce output voltage. When the output voltage drops below approx. 50% of the nominal value of output voltage, the converter will shutdown.

Once the converter has shut down, it will attempt to restart every 2 seconds until the overload or short circuit conditions are removed or the output voltage rises above 45% of its nominal value within 100 msec.

Once the output current is brought back into its specified range, the converter automatically exits the hiccup mode and continues normal operation.

In case of startup into short circuit, internal logic detects short circuit condition and shuts down converter typically 5 msec after the condition is detected. The converter will attempt to restart after 2 seconds until short circuit condition exists.

1000 WATT FXP SERIES DC/DC CONVERTERS



Output Overvoltage Protection (OVP)

The converter will shut down if the output voltage across +OUT (Pins 5 and 6) and –OUT (Pins 8 and 9) exceeds the threshold of the OVP circuitry. The OVP circuitry contains its own reference, independent of the output voltage regulation loop. Once the converter has shut down, it will attempt to restart every 2 seconds until the OVP condition is removed.

Note that OVP threshold is set for nominal output voltage and not trimmed output voltage value or remote sense voltage.

Overtemperature Protection (OTP)

The FXP converters have non-latching overtemperature protection. It will shut down and disable the output if temperature at the center of the base plate exceeds a threshold of typical 108°C for 9Vin, 112 °C for 12Vin and 115 °C for 24Vin/36Vin. Measured with FXP converter soldered to 5" x 3.5" x 0.07" 4 layers/ 2 Oz Cooper FR4 PCB.

The converter will automatically restart when the base temperature has decreased by approximately 20°C.

Safety Requirements

Basic Insulation is provided between input and the output. The converters have no internal fuse. To comply with safety agencies requirements, a fast-acting or time-delay fuse is to be provided in the unearthened lead. Recommended fuse values are:

- 140A for 9V<Vin<18V
- 90A for 18V<Vin<36V.

Electromagnetic Compatibility (EMC)

EMC requirements must be met at the end-product system level, as no specific standards dedicated to EMC characteristics of board mounted component dc-dc converters exist.

With the addition of a two stage external filter, the FXP converters will pass the requirements of MILSTD-461F CE102 Base Curve for conducted emissions. Note that 5uH LISN should be used in order to enable operation of the converter at low input voltage.

Remote Sense Pins (Pins 10 and 11)

Sense inputs compensate for output voltage inaccuracy delivered at the load.

The sense input and power Vout pins are internally connected through 100Ω (SENSE+ to +OUT) and 0 Ω (SENSE- to –OUT) resistors enabling the converter to operate without external connection to the Sense. If the

Sense function is not used for remote regulation, the user should connect SENSE+ (Pin 11) to +OUT (Pins 5 and 6) at the converter pins. Note that SENSE- (Pin 10) is internally connected to –OUT (Pins 8 and 9) and should be used for connecting Trim-down resistor when trimming function is used. *Do not connect this pin to –OUT externally.*

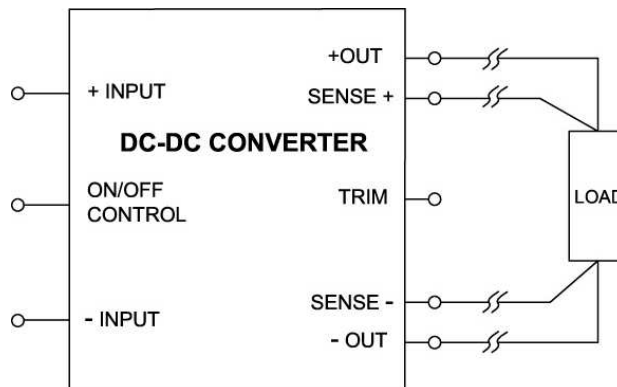

Fig. 2: Circuit configuration for Remote sense function.

SENSE+ line must be treated with care in PCB layouts and should run adjacent to DC signals. If cables and discrete wiring is used, it is recommended to use twisted pair, shielded tubing or similar techniques.

The maximum voltage difference between Sense inputs and corresponding power pins should be kept below 1V, i.e.:

$$V(\text{SENSE+}) - V(+\text{OUT}) \leq 1\text{V}$$

Note that maximum output power is determined by maximum output current and highest output voltage at the output pins of the converter:

$$[V(+\text{OUT}) - V(-\text{OUT})] \times I_{\text{out}} \leq P_{\text{out rated}}$$

Output Voltage Adjust/TRIM (Pin 12)

The TRIM (Pin 12) allows user to adjust output voltage 10% up or -40% down relative to rated nominal voltage by addition of external trim resistor. Trim resistor should be mounted close to the converter and connected with short leads. Internal resistor in the converter used for the TRIM is high precision 0.1% with temperature coefficient 25 ppm/ °C. The accuracy of the TRIM is therefore determined by tolerance of external Trim resistor. If trimming is not used, the TRIM pin should be left open.

Trim Down – Decrease Output Voltage

Trimming down is accomplished by connecting an external resistor, $R_{\text{trim-down}}$, between the TRIM (pin 12) and the SENSE- (pin 10), with a value of:

1000 WATT FXP SERIES DC/DC CONVERTERS



$$R_{trim-down} = \left(\frac{499}{\Delta} - 9.98 \right) \text{ [k}\Omega\text{]}$$

Where,

$R_{trim-down}$ = Required value of the trim-down resistor [kΩ]

$V_{O(NOM)}$ = Nominal value of output voltage [V]

$V_{O(REQ)}$ = Required value of output voltage [V]

$$\Delta = \left| \frac{V_{O(REQ)} - V_{O(NOM)}}{V_{O(NOM)}} \right| \text{ [%]}$$

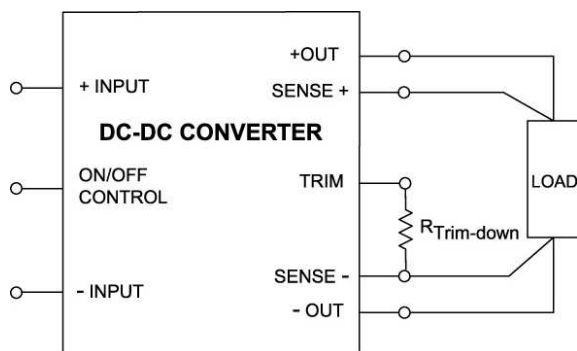

Fig. 3: Circuit configuration for Trim-down function

To trim the output voltage 10% ($\Delta=10$) down, required external trim resistance is:

$$R_{trim-down} = \left(\frac{499}{10} - 9.98 \right) = 39.92 \text{ k}\Omega$$

Trim Up – Increase Output Voltage

Trimming up is accomplished by connecting an external resistor, $R_{trim-up}$, between the TRIM (pin 12) and the SENSE+ (pin 11), with a value of:

$$R_{trim-up} = 4.99 * \left\{ \left[\frac{V_{O(NOM)} * (100 + \Delta)}{1.25\Delta} \right] - \left(\frac{100 + 2\Delta}{\Delta} \right) \right\} \text{ [k}\Omega\text{]}$$

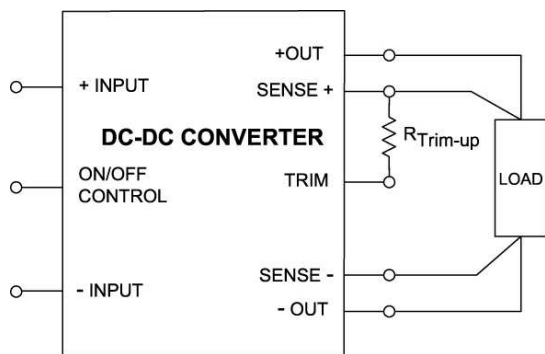

Fig. 4: Circuit configuration for Trim-up function

To trim the output voltage up, for example 24V to 26.4V, $\Delta=10$ and required external resistor is:

$$R_{trim-up} = 4.99 * \left\{ \left[\frac{24 * (100 + 10)}{1.25 * 10} \right] - \left(\frac{100 + 2 * 10}{10} \right) \right\} = 1015 \text{ k}\Omega$$

Note that trimming output voltage more than 10% is not

recommended and OVP may be tripped.

Active Voltage Programming

In applications where output voltage need to be adjusted actively, an external voltage source, such as for example a Digital-to-Analog converter (DAC), capable of both sourcing and sinking current can be used. It should be connected across with series resistor R_g across TRIM (Pin 12) and SENSE- (Pin 10). External trim voltage should not be applied before converter is enabled in order to provide proper startup output voltage waveform and prevent tripping overvoltage protection. Please contact Calex technical representative for more details.

Thermal Consideration

The FXP converter can operate in a variety of thermal environment. However, in order to ensure reliable operation of the converter, sufficient cooling should be provided. The FXP converter is encapsulated in plastic case with metal baseplate on the top. In order to improve thermal performance, power components inside the unit are thermally coupled to the baseplate. In addition, thermal design of the converter is enhanced by use of input and output pins as heat transfer elements. Heat is removed from the converter by conduction, convection and radiation.

There are several factors such as ambient temperature, airflow, converter power dissipation, converter orientation how converter is mounted as well as the need for increased reliability that need to be taken into account in order to achieve required performance. It is highly recommended to measure temperature in the middle of the baseplate in particular application to ensure that proper cooling of the converter is provided.

A reduction in the operating temperature of the converter will result in an increased reliability.

Parallel Operation

The FXP converters are designed for parallel operation. Current sharing within <10% is achieved using voltage droop method that eliminates need for current share pin. Up to three FXP converters with same nominal output voltage can be connected in parallel with capability to provide at least 2.8 kW output power. Output voltage droops linearly with output current with typical voltage drop of 2.5% for full range of change from zero to maximum rated current.

When using the FXP converter in parallel operation it is important to follow below provided recommendations:

1. The FXP converters connected in parallel need to be close to each other with minimum resistance between their output power pins. In order to achieve specified current share accuracy it is necessary to make connection with shortest possible traces

1000 WATT FXP SERIES DC/DC CONVERTERS



keeping resistance between load and output pins of each converter symmetric. Any imbalance of the resistance between output pins and load among converters in parallel will affect accuracy of current sharing.

2. ON/OFF pins of the FXP converters need to be connected together and used to turn-on or turn-off converters simultaneously.
3. If ON/OFF pin is not used, +ON/OFF pin should be either left open (Positive logic) or shorted to – ON/OFF pin (Negative Logic).
4. Remote sense pins:
 - a. If not used, SENSE+ should be connected with short traces to +OUT and SENSE- left open for each converter.
 - b. If used, should be connected together among the converters operating in parallel and with one pair of lines to the load.
5. TRIM Function
 - a. If not used leave it open.
 - b. If used, connect all TRIM pins together and follow instruction described in *Output voltage adjust/TRIM* section. For Trim-down, connect SENSE- pins together and for Trim-up connect all SENSE+ pins together.

Minimum Load Current

When FXP converters are connected in parallel there will be always one with highest V_{out} no load set point. In case of startup into no load condition, the FXP with highest V_o set point will turn on and operate while the other with lower no load set point will be off. Once load current exceeds typically 4% (maximum 10%) of rated output current for one FXP the other FXP with lower set point will turn on and converters will start sharing current. Note that min load current is only required during startup to ensure that both converters are on. After that all converters connected in parallel will operate even if load current drops to zero.

When Trim function (with trim resistors) is used for the FXP connected in parallel, if minimum load current is not provided during initial startup, output voltage will be out of regulation at 75% of its nominal value. Once minimum load current is provided, the converter will lower set point will start operating and output voltage will be in regulation. After that converters will operate in parallel even if load current drops to zero.

Maximum Load Current

Maximum load current is given by:

$$I_{max} = I_o [1 + 0.9(n - 1)]$$

Where,

I_o - Rated output current of one FXP

n - Number of FXPs connected in parallel

The FXP converters connected in parallel will start into maximum load current (resistive load) when connected as described above.

Thermal Derating

There are two most common applications: 1) the FXP converter is thermally attached to a cold plate inside chassis without any forced internal air circulation; 2) the FXP converter is mounted in an open chassis on system board with forced airflow with or without an additional heatsink attached to the base plate of the FXP converter.

The best thermal results are achieved in application 1) since the converter is cooled entirely by conduction of heat from the top surface of the converter to a cold plate and temperature of the components is determined by the temperature of the cold plate. There is also some additional heat removal through the converter's pins to the metal layers in the system board. It is highly recommended to solder pins to the system board rather than using receptacles. Typical derating output power and output current are shown in Figs.15-18 as function of baseplate temperature up to 105C. Note that operating converter at these limits for prolonged time will affect reliability.

Soldering Guidelines

The ROHS-compliant through-hole FXP converters use Sn/Ag/Cu Pb-free solder and ROHS-compliant component. They are designed to be processed through wave soldering machines. The pins are 100% matte tin over nickel plated and compatible with both Pb and Pb-free wave soldering processes. It is recommended to follow specifications below when installing and soldering FXP converters. Exceeding these specifications may cause damage to the FXP converter.

Wave Solder Guideline For Sn/Ag/Cu based solders	
Maximum Preheat Temperature	115 °C
Maximum Pot Temperature	270 °C
Maximum Solder Dwell Time	7 seconds
Wave Solder Guideline For Sn/Pb based solders	
Maximum Preheat Temperature	105 °C
Maximum Pot Temperature	250 °C
Maximum Solder Dwell Time	6 seconds

FXP converters are not recommended for water wash process. Contact the factory for additional information if water wash is necessary.



1000 WATT FXP SERIES DC/DC CONVERTERS



Test Configuration

Test setup for measuring input reflected ripple current i_c , output voltage ripple, startup waveforms and step load transient waveforms is shown in Figures 5 and 6. External component values are shown in Table 1. Output capacitors are selected with low ESR. In addition 100 μF / 24 m Ω capacitor is selected due to quite stable ESR at -40 C $^\circ$ (only 2 x increase) while capacitors 220 μF /100m Ω and 470 μF /76m Ω have typical increase in ESR of 6 to 8 times at -40 C $^\circ$. All waveforms are taken using oscilloscope with BWL =20MHz.

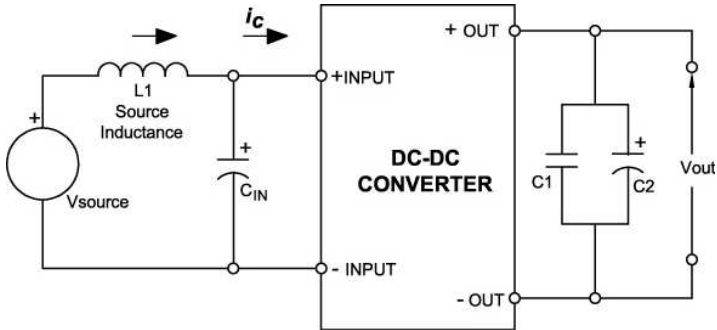

Fig. 5: Test setup for measuring input reflected ripple currents i_c .

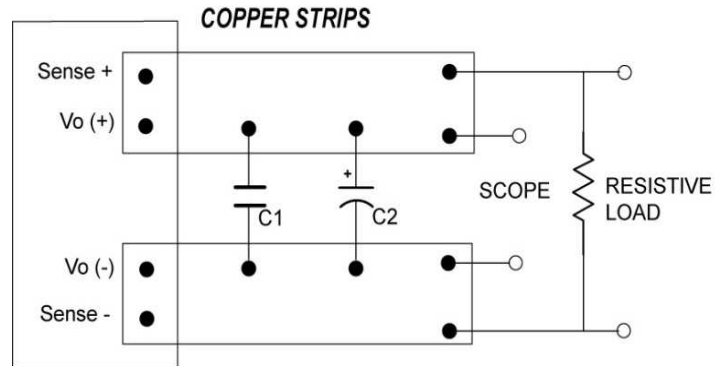

Fig. 6: Test setup for measuring output voltage ripple, startup and step load transient waveforms.

Ref. Des.	Manufacturing p/n	24S24.42FXP/ 24S28.36FXP	24S48.21FXP/ 24S53.19FXP
L1	N/A	100nH	100nH
C _{IN}	MAL214699108E3 (Vishay)	2 x 470 μF /72m Ω (650m Ω)	2 x 470 μF /76m Ω (650m Ω)
C1	GRM32ER72A475KA12L	10 μF /1210/X7R/100v	10 μF /1210/X7R/100v
C2	PCR1J101MCL1GS (nichicon)	3 x 100 μF / 63V/ 24 m Ω (48 m Ω)	N/A
	PCR1K680MCL1GS (nichicon)	N/A	3 x 68 μF / 80V/ 28 m Ω (56 m Ω)
	UPS2A221MPD (nichicon)	220 μF /100V/100m Ω	220 μF /100V/ 100m Ω
	MAL214699108E3 (Vishay)	470 μF / 72m Ω (650m Ω)	N/A

Table 1: Component values used in test setup from Figs. 5 and 6. Resistance in () represents ESR value at -40C represents ESR value at -40C for specified capacitor.

1000 WATT FXP SERIES DC/DC CONVERTERS



Characteristic Curves – Efficiency and Power Dissipation

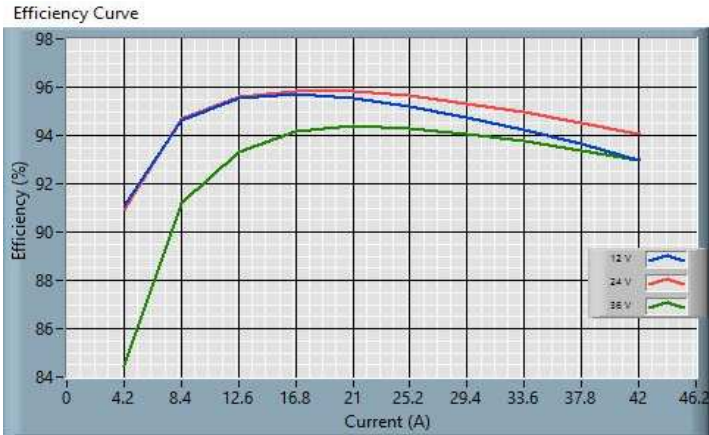

Fig. 7: 24S24.42FXP (ROHS) Efficiency Curve

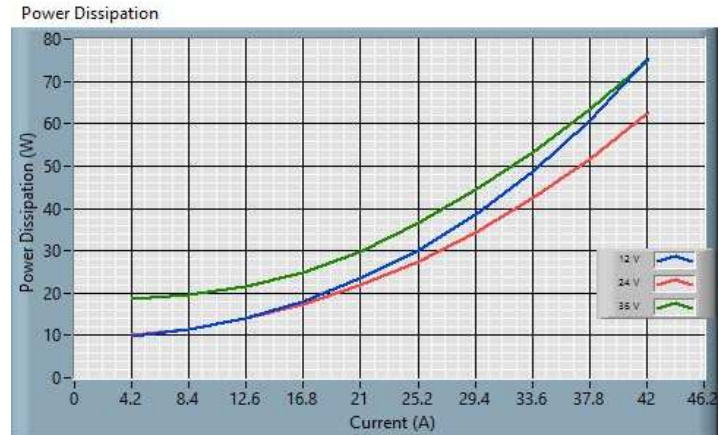

Fig. 8: 24S24.42FXP (ROHS) Power Dissipation

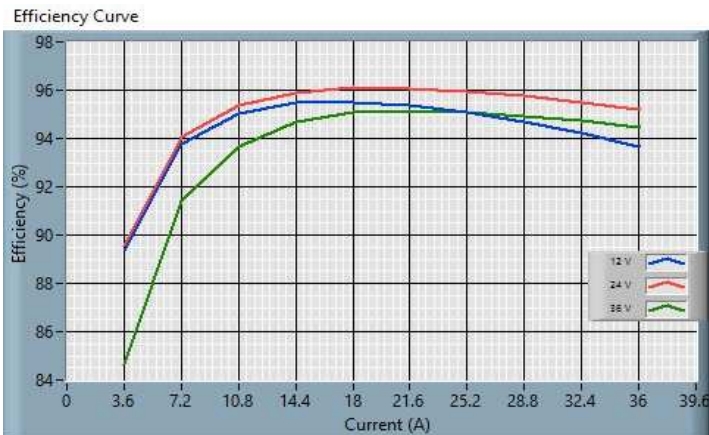

Fig. 9: 24S28.36FXP (ROHS) Efficiency Curve

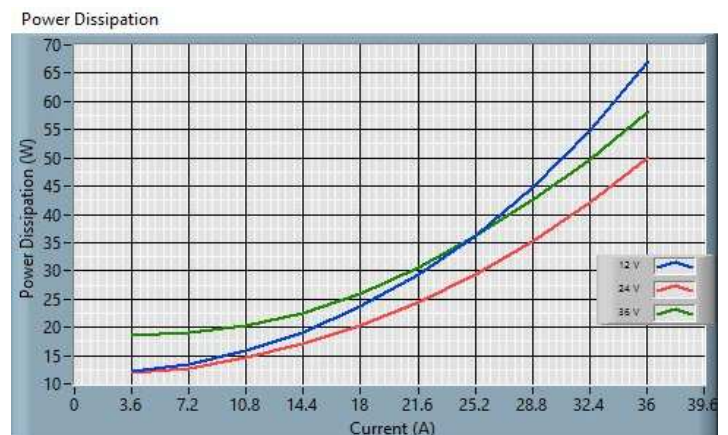

Fig. 10: 24S28.36FXP (ROHS) Power Dissipation

1000 WATT FXP SERIES DC/DC CONVERTERS



Characteristic Curves – Efficiency and Power Dissipation (Cont'd)

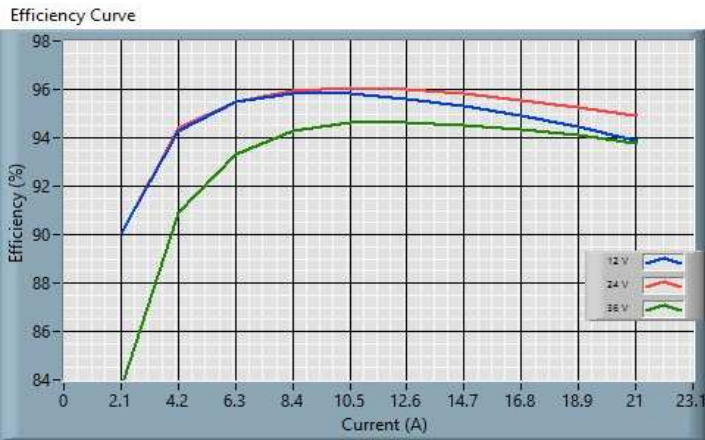

Fig. 11: 24S48.21FXP (ROHS) Efficiency Curve

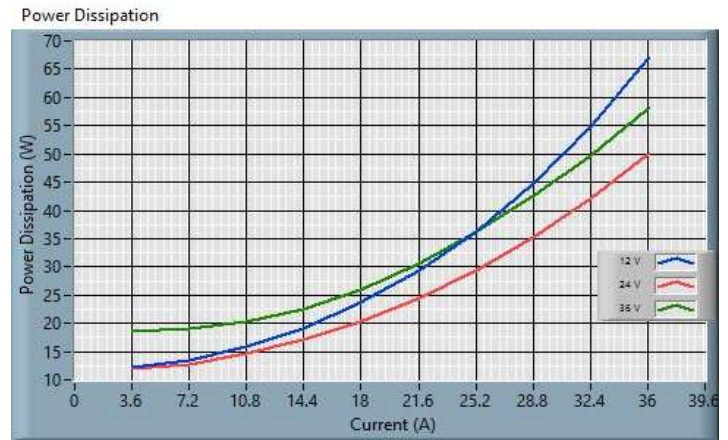

Fig. 12: 24S48.21FXP (ROHS) Power Dissipation

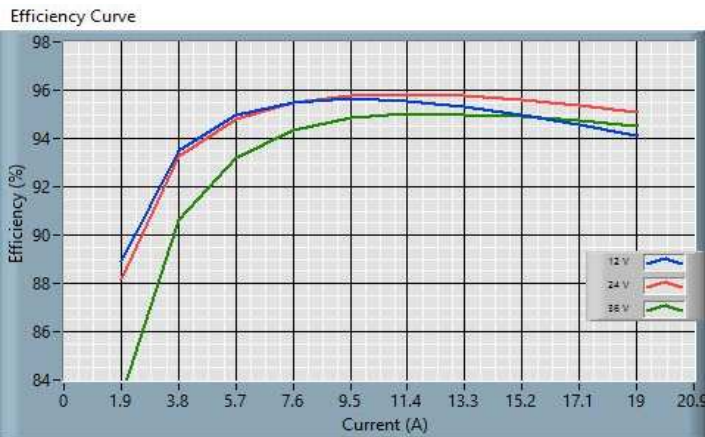

Fig. 13: 24S53.19FXP (ROHS) Efficiency Curve

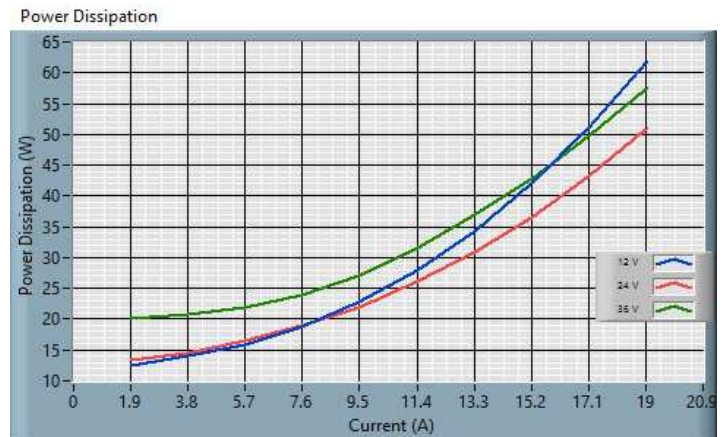

Fig. 14: 24S53.19FXP (ROHS) Power Dissipation

1000 WATT FXP SERIES DC/DC CONVERTERS



Characteristic Curves – Derating Curves

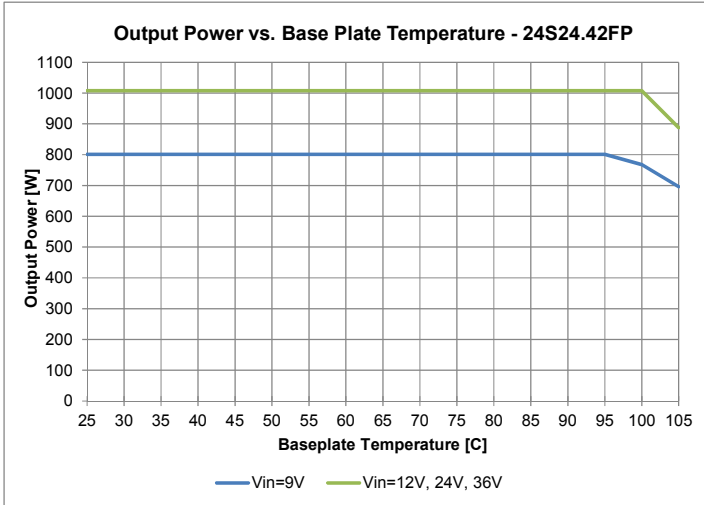

Fig. 15: 24S24.42FXP (ROHS) Derating Curve

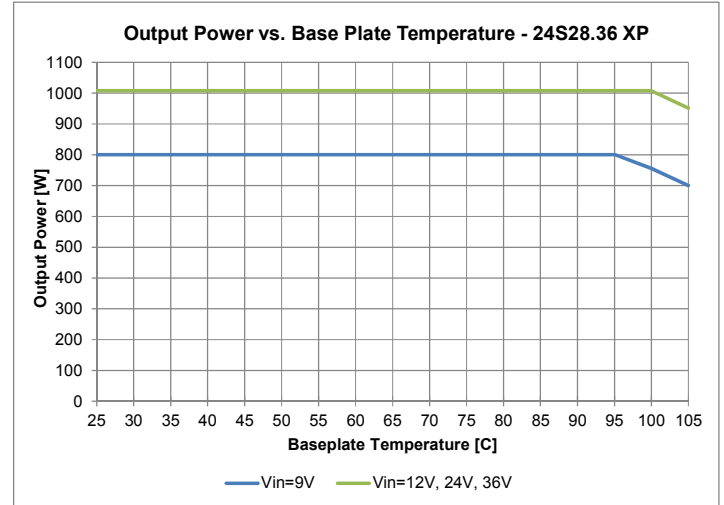

Fig. 16: 24S28.36FXP (ROHS) Derating Curve

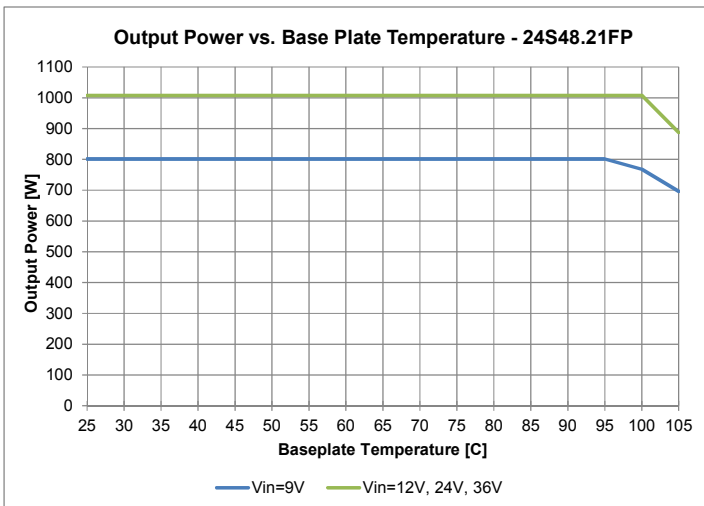

Fig. 17: 24S48.21FXP (ROHS) Derating Curve

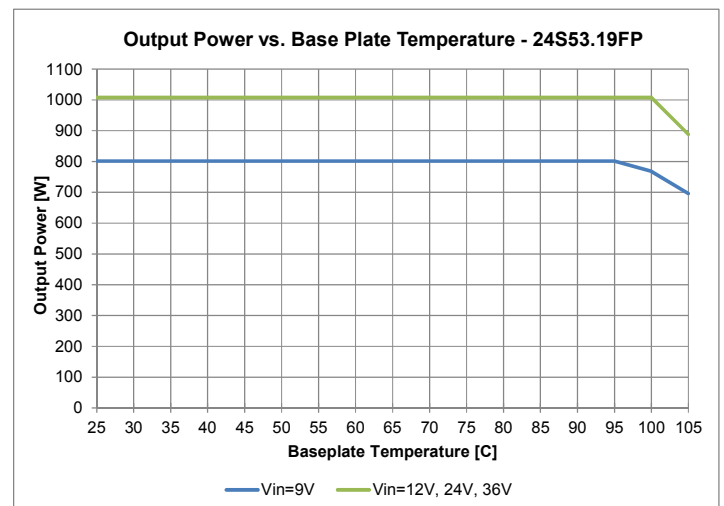

Fig. 18: 24S53.19FXP (ROHS) Derating Curve

1000 WATT FXP SERIES DC/DC CONVERTERS



Characteristic Waveforms ($V_{in} = 24V$) – 24S24.42FXP

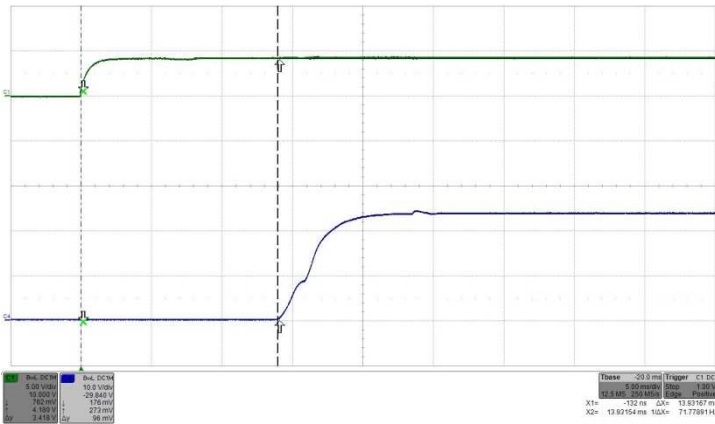

Fig. 19: Turn-on by ON/OFF transient (with V_{in} applied) at full rated load current (resistive load). Top trace (C1): ON/OFF signal, Bottom trace (C4): Output voltage.

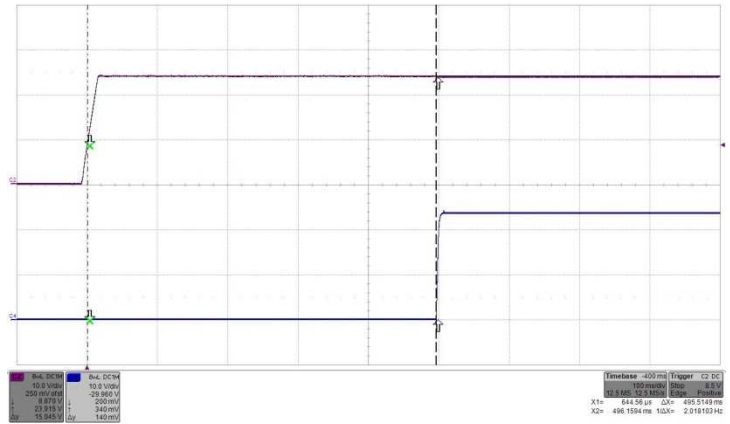

Fig. 20: Turn-on by V_{in} transient (converter enabled) at full rated load current (resistive load). Top trace (C2): Input voltage V_{in} , Bottom trace (C4): Output voltage.

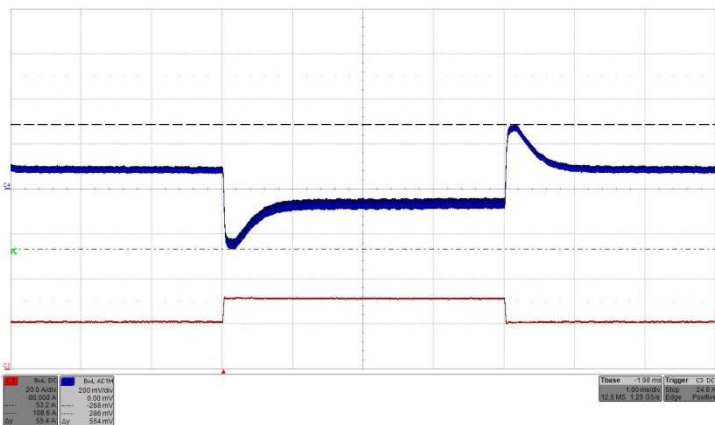

Fig. 21: Output voltage response to load current step change 50% - 75%-50% (21A–31.5A–21A) with $di/dt = 1A/\mu s$. Top trace (C4): Output voltage, Bottom trace (C3): Load current.

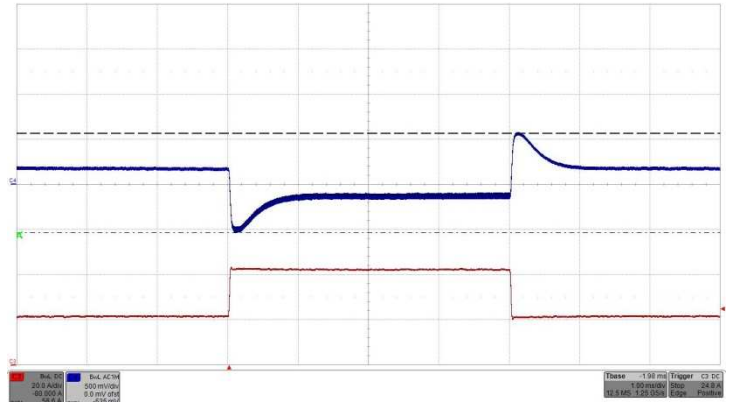

Fig. 22: Output voltage response to load current step change 50% - 100%-50% (21A–42A–21A) with $di/dt = 1A/\mu s$. Top trace (C4): Output voltage, Bottom trace (C3): Load current.

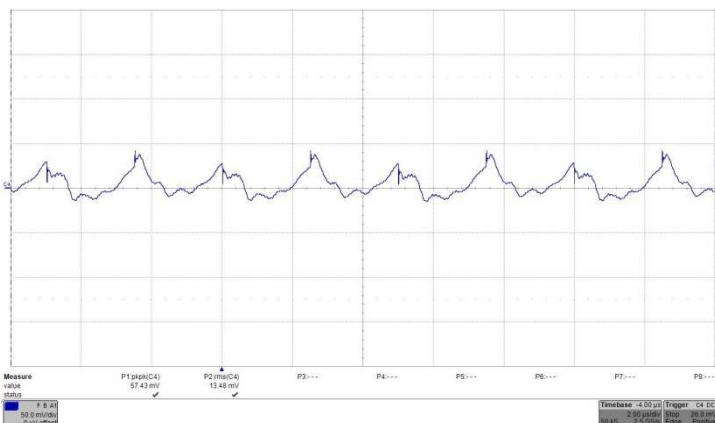

Fig. 23: Output voltage ripple at full rated load current.

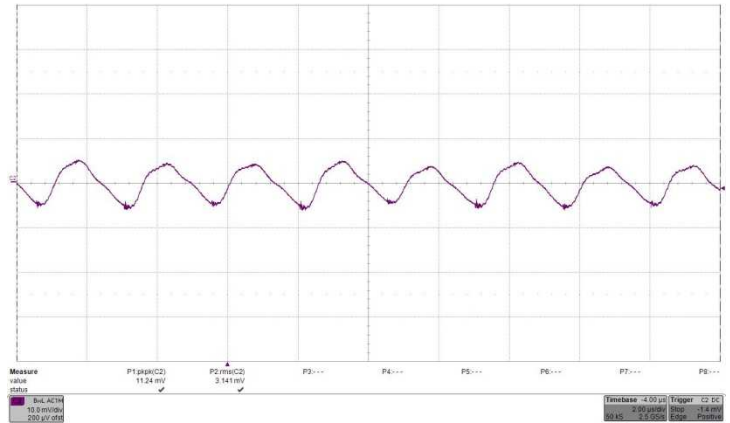

Fig. 24: Input reflected ripple current, i_c (500mA/mV), measured at input terminals at full rated load current. RMS input ripple current $i_c = 3.14 \cdot 0.5A = 1.07 A_{rms}$ (See Fig. 5).



1000 WATT FXP SERIES DC/DC CONVERTERS



Characteristic Waveforms – 24S28.36FXP

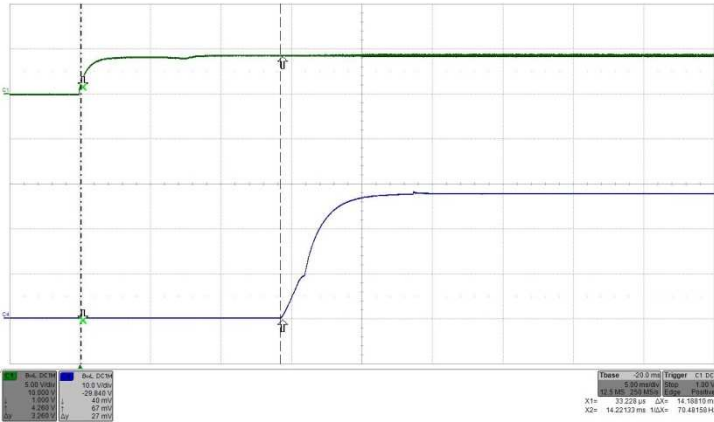

Fig. 25: Turn-on by ON/OFF transient (V_{in} applied) at full rated load current (resistive). Top Trace (C1): ON/OFF signal, Bottom Trace (C4): Output voltage.

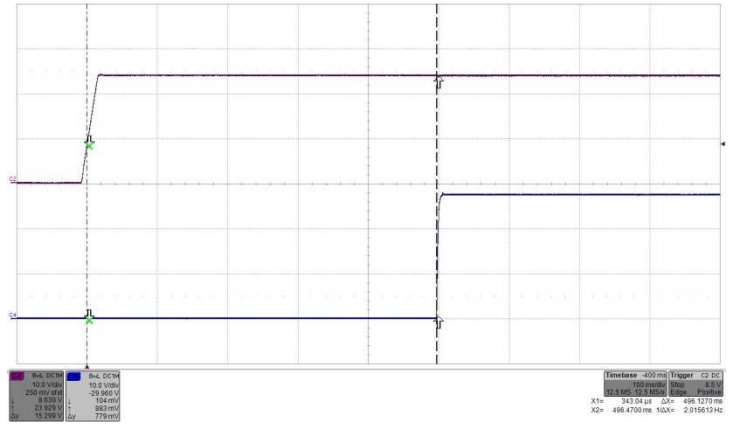

Fig. 26: Turn-on by V_{in} (converter enabled) transient at full rated load current (resistive). Top trace (C2): Input voltage V_{in} , Bottom trace (C4): Output voltage.

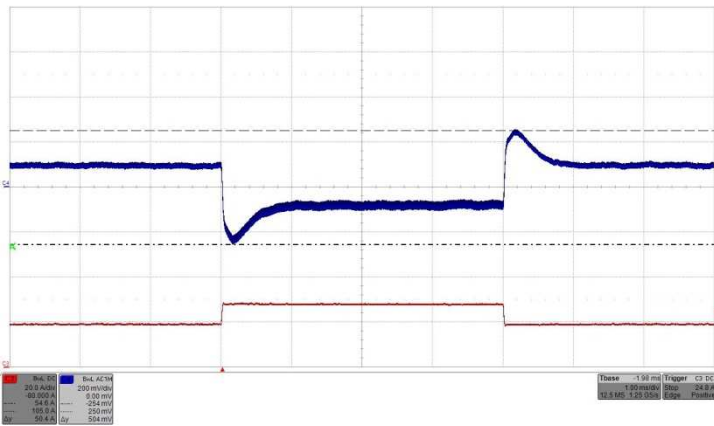

Fig. 27: Output voltage response to load current step change 50% - 75%-50% (18A-27A-18A) with $di/dt = 1A/\mu s$. Top trace (C4): Output voltage, Bottom trace (C3): Load current.

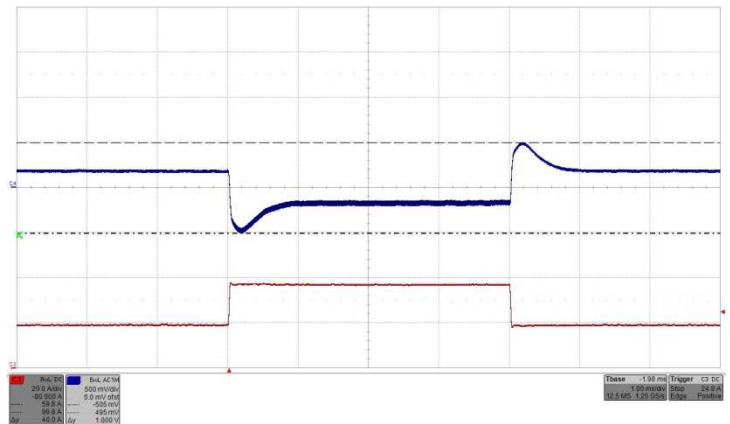

Fig. 28: Output voltage response to load current step change 50% - 100%-50% (18A-36A-18A) with $di/dt = 1A/\mu s$. Top trace (C4): Output voltage, Bottom trace (C3): Load current.

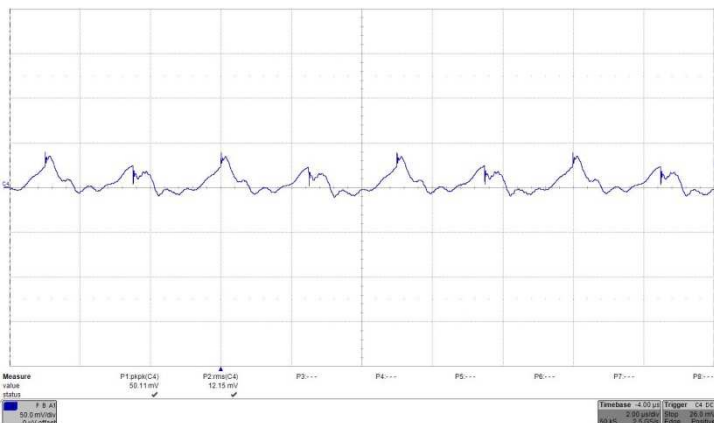

Fig. 29: Output voltage ripple at full rated load current.

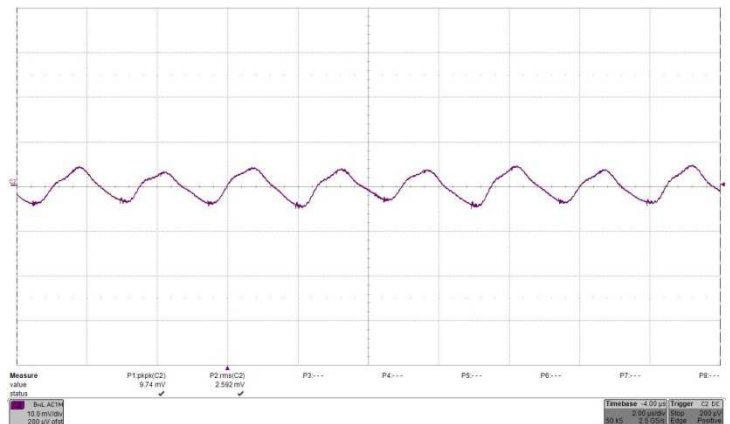

Fig. 30: Input reflected ripple current, i_c , measured at input terminals at full rated load current. Refer to Fig. 2 for test setup. RMS input ripple current $i_c = 2.6 * 0.5A = 1.3A_{rms}$.

1000 WATT FXP SERIES DC/DC CONVERTERS



Characteristic Waveforms – 24S48.21FXP

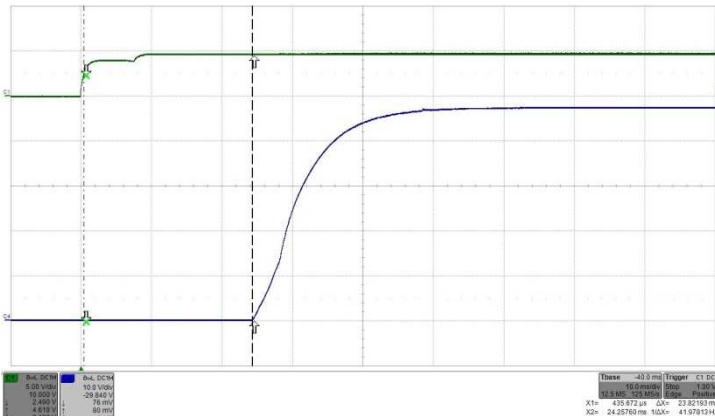

Fig. 31: Turn-on by ON/OFF transient (V_{in} applied) at full rated load current (resistive). Top trace (C1): ON/OFF signal, Bottom trace (C4): Output voltage.

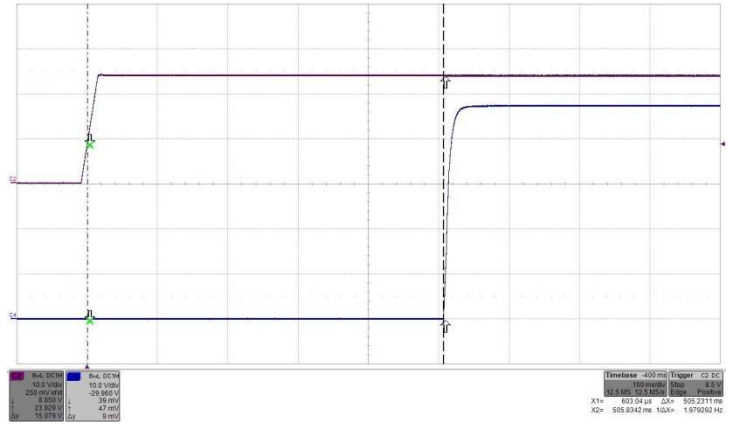

Fig. 32: Turn-on by V_{in} (ON/OFF high) transient at full rated load current (resistive). Top trace (C2): Input voltage, Bottom trace (C4): Output voltage.

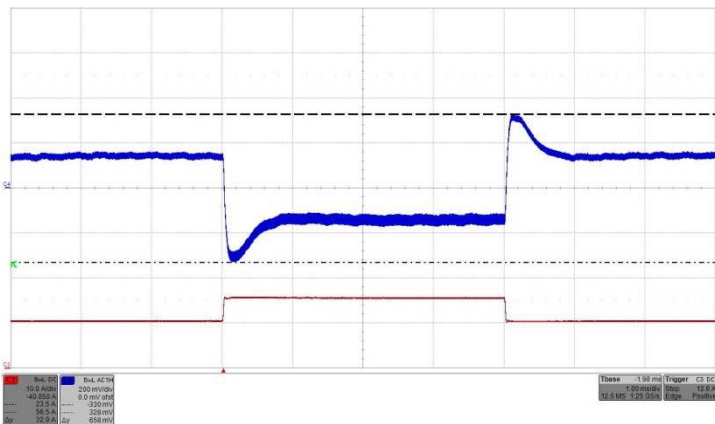

Fig. 33: Output voltage response to load current step change 50% - 75%-50% (10.5A–15.75A–18A) with $di/dt = 1A/\mu s$. Top trace (C4): Output voltage, Bottom trace (C3): Load current.

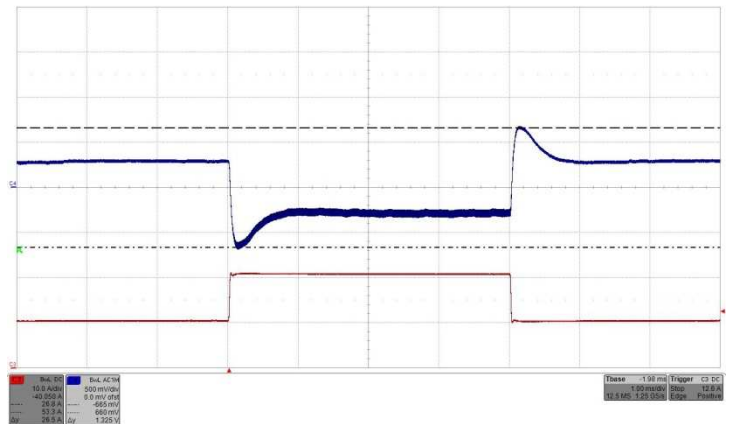

Fig. 34: Output voltage response to load current step change 50% - 100%-50% (10.5A–21A–10.5A) with $di/dt = 1A/\mu s$. Top trace (C4): Output voltage, Bottom trace (C3): Load current.

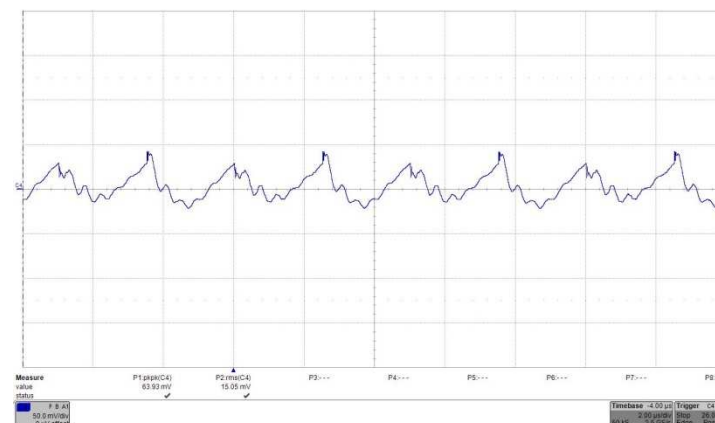

Fig. 35: Output voltage ripple at full rated load current.

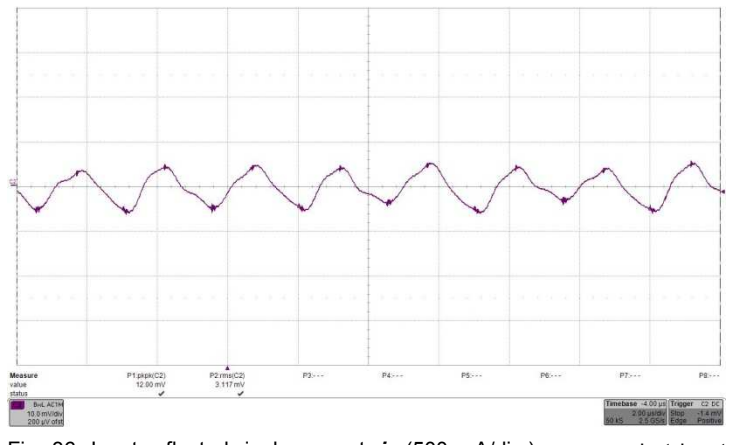

Fig. 36: Input reflected ripple current, i_c (500 mA/div.), measured at input terminals at full rated load current. Refer to Fig. 2 for test setup. RMS input ripple current $i_c = 3.12 \cdot 0.5A = 1.56A_{rms}$.



1000 WATT FXP SERIES DC/DC CONVERTERS



Characteristic Waveforms – 24S53.19FXP

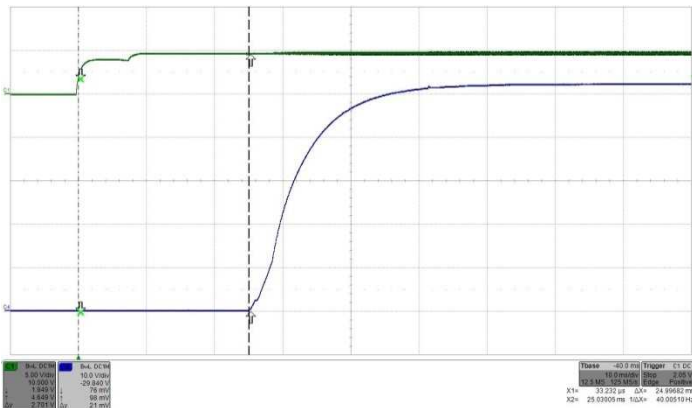

Fig. 37: Turn-on by ON/OFF transient (V_{in} applied) at full rated load current (resistive). Top trace (C1): ON/OFF signal, Bottom trace (C4): Output voltage.

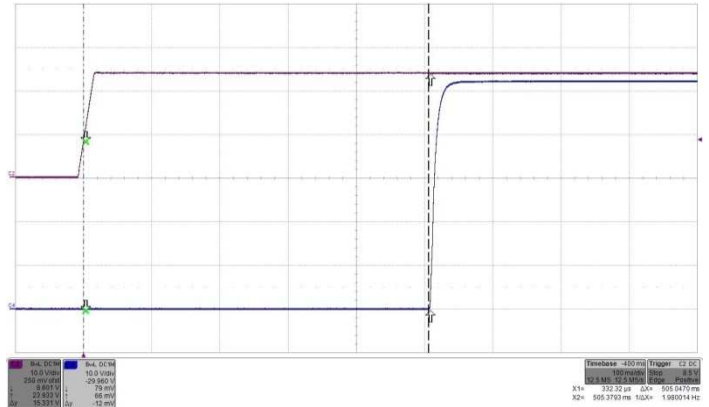

Fig. 38: Turn-on by V_{in} (ON/OFF high) transient at full rated load current (resistive). Top trace (C2): Input voltage V_{in} , Bottom trace (C4): Output voltage.

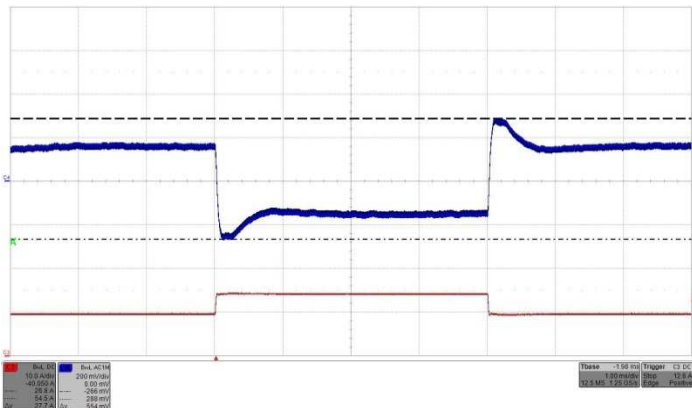

Fig. 39: Output voltage response to load current step change 50% - 75% - 50% (9.5A–14.25A–18A) with $di/dt = 1A/\mu s$. Top trace (C4): Output voltage, Bottom trace (C3): Load current.

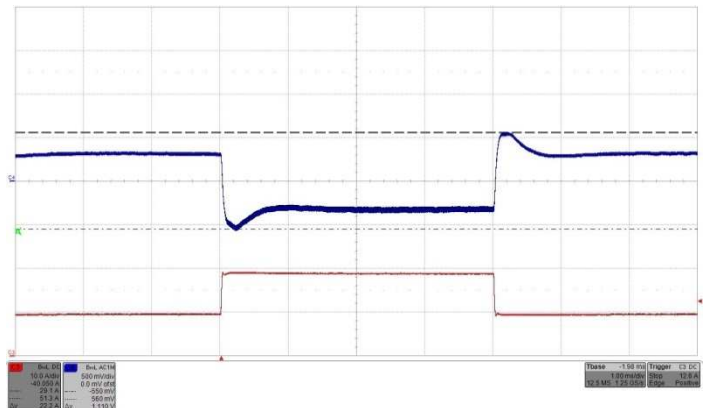

Fig. 40: Output voltage response to load current step change 50% - 100% - 50% (18A–36A–18A) with $di/dt = 1A/\mu s$. Top trace (C4): Output voltage, Bottom trace (C3): Load current.

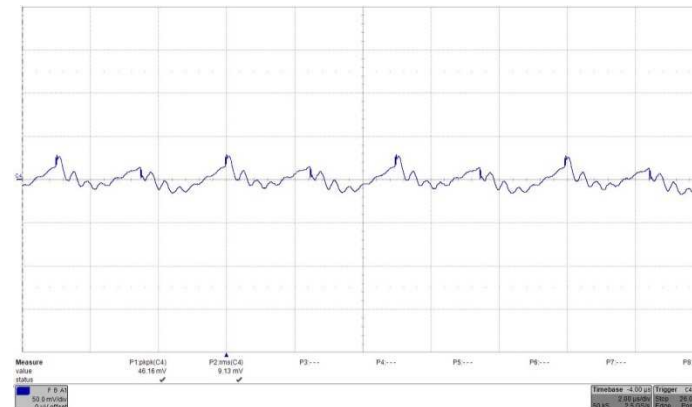

Fig. 41: Output voltage ripple at full rated load current.

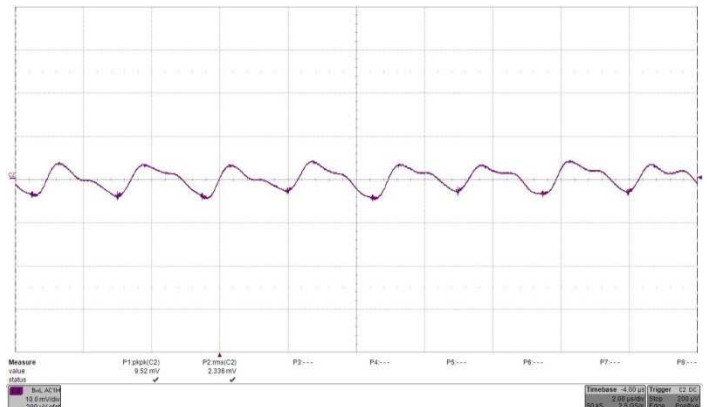

Fig.42: Input reflected ripple current, i_c (500 mA/div.), measured at input terminals at full rated load current. Refer to Fig. 2 for test setup. RMS input ripple current $i_c = 2.34 \cdot 0.5A = 1.17A_{rms}$.

1000 WATT FXP SERIES DC/DC CONVERTERS



EMC Consideration

The filter circuit schematic for suggested input filter configuration as tested to meet the conducted emission limits of MILSTD-461F CE102 Base Curve is shown in Fig. 43. The plots of conducted EMI spectrum measured using 5uH LISNs are shown in Figures 44 and 45.

Note: Customer is ultimately responsible for the proper selection, component rating and verification of the suggested parts based on the end application.

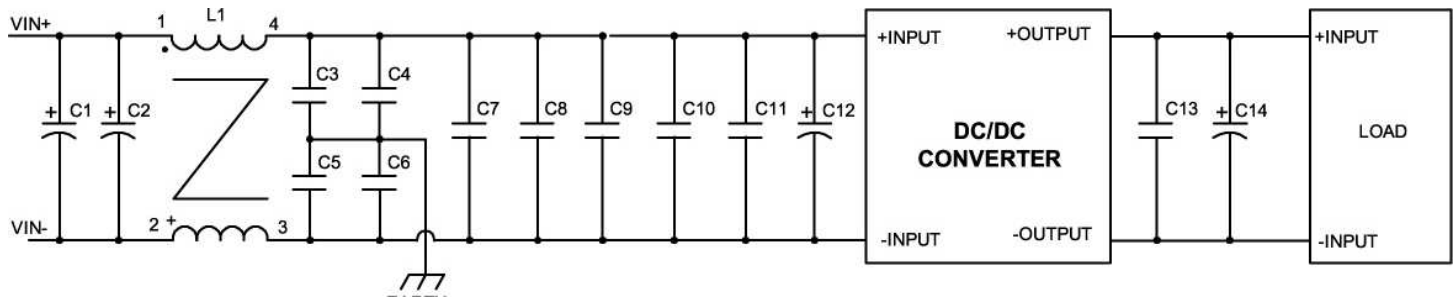

Component Designator	Description
C1, C2, C12, C14	470uF/100V/70mΩ Electrolytic Capacitor (Vishay MAL214699108E3 or equivalent)
C12	2 x 470uF/100V/70mΩ Electrolytic Capacitor (Vishay MAL214699108E3 or equivalent)
C3, C4, C5, C6	4.7nF/1210/X7R/2kV Ceramic Capacitor
C7, C8, C9, C10, C11, C13	10μF/1210/X7R/50V Ceramic Capacitor
L1	CM choke, 130μH, Leakage = 0.6μH (4T on toroid 22.1mm x 13.7 mm x 7.92 mm)

Fig. 43: Typical input EMI filter circuit with component values used to attenuate conducted emissions per MILSTD-461F CE102 Base Curve.

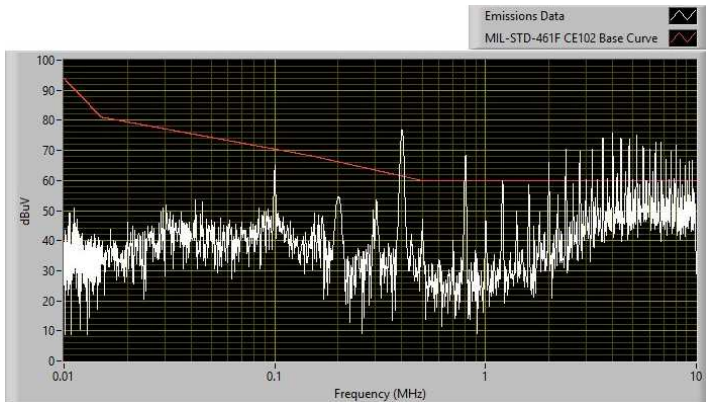

a) Without input filter from Fig. 23 (C9 = 2 x 470μF/50V/70mΩ)

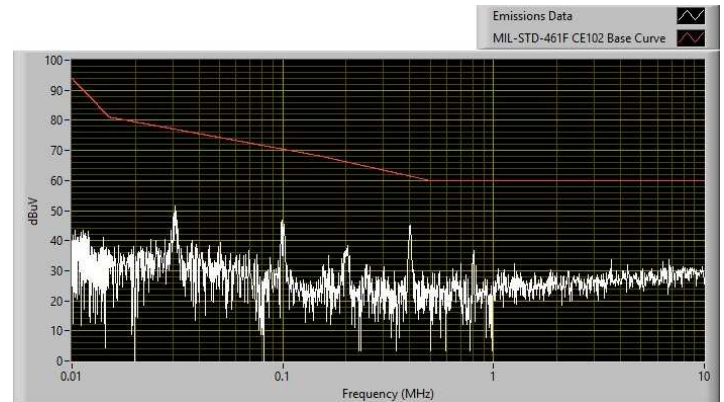

b) With input filter from Fig. 23.

Fig. 44: Input conducted emissions measurement (Typ.) of 24S28.36FXP.

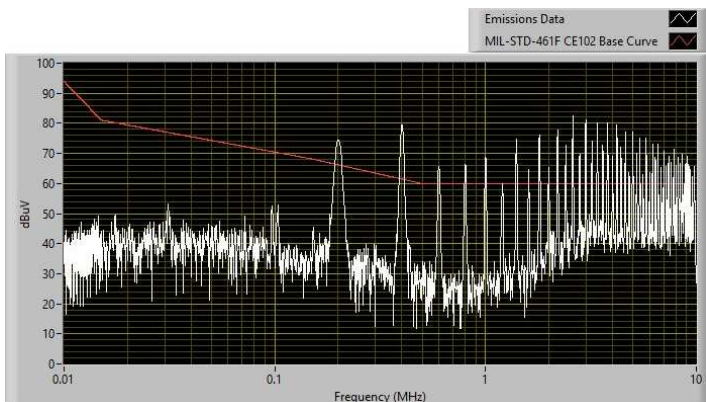

a) Without input filter from Fig. 23 (C9 = 2 x 470μF/50V/70mΩ)

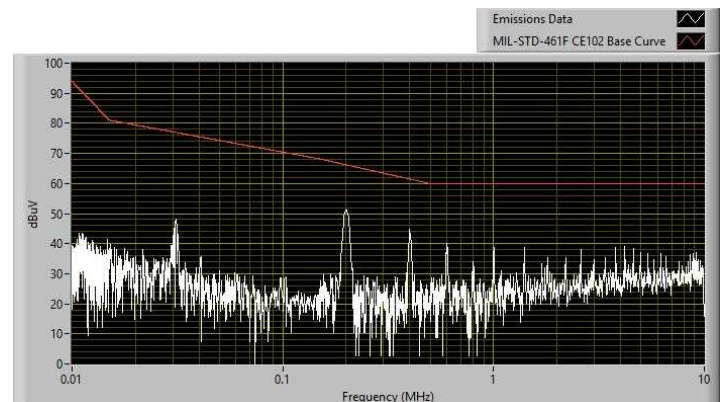

b) With input filter from Fig. 23

Fig. 45: Input conducted emissions measurement (Typ.) of 24S53.19FXP.



1000 WATT FXP SERIES DC/DC CONVERTERS



Mechanical Specification

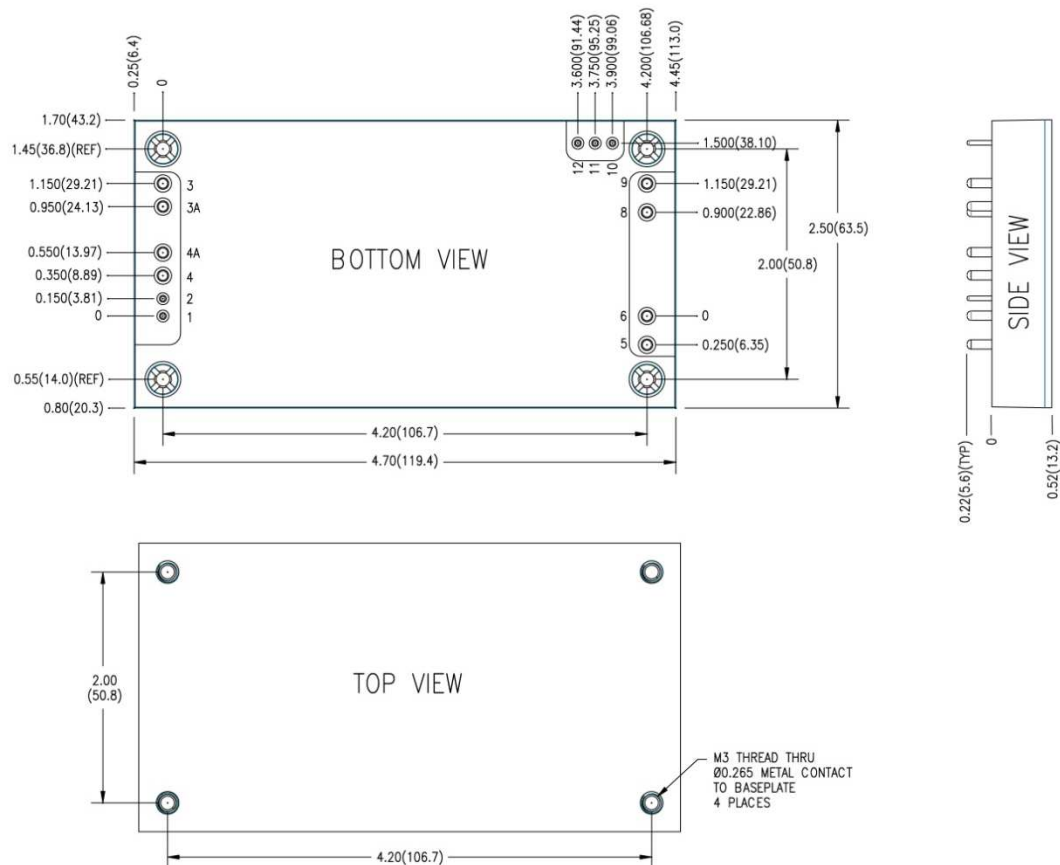

Input/ Output Connections

Pin	Label	Function
1	+ON/OFF	TTL input with internal pull up, referenced to — ON/OFF pin, used to turn converter on and off
2	-ON/OFF	Negative input of Remote ON/OFF
3	-INPUT	Negative Input Voltage
3A	-INPUT	Negative Input Voltage
4	+INPUT	Positive Input Voltage
4A	+INPUT	Positive Input Voltage
5	+OUT	Positive Output Voltage
6	+OUT	Positive Output Voltage
8	-OUT	Negative Output Voltage
9	-OUT	Negative Output Voltage
10	SENSE-	Negative Remote Sense (Used for Trim)
11	SENSE+	Positive Remote Sense
12	TRIM	Used to trim output voltage 60% - 100%

Note:

- Pinout as well as pin number and pin diameter are inconsistent between manufacturers of the full brick converters. Make sure to follow the pin function, not the pin number, as well as spec for pin diameter when laying out your board.

NOTES:

Unless otherwise specified:

All dimensions are in inches [millimeter]

Tolerances: x.xx in. ± 0.02 in. [x.x mm ± 0.5 mm]

x.xxx in. ± 0.010 in. [x.xx mm ± 0.25 mm]

Torque fasteners into threaded mounting inserts at 10 in.lbs. or less. Greater torque may result in damage to unit and void the warranty.

