

**KEMET Part Number: ESD-R-291216H-NC23**  
(UECESDN0291203)

KEMET, ESD-R-NC, EMI Cores, Noise Suppression

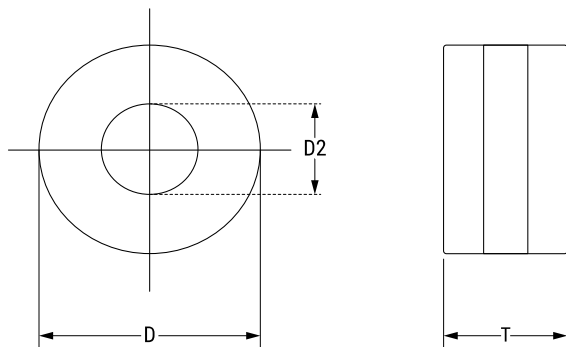

General Information	
<b>Series:</b>	ESD-R-NC
<b>Style:</b>	Round - Toroidal
<b>Cable Type:</b>	Round Cable
<b>Description:</b>	EMI Core Solid, Large-Size Ring Type, For Round Cables
<b>Features:</b>	Low and High Frequency Range, Flame Retardancy
<b>RoHS:</b>	Yes
<b>Qualifications:</b>	UL94V-0
<b>Case Color:</b>	Black with yellow tape
<b>Materials:</b>	Nanocrystal

Dimensions	
<b>D</b>	29mm MAX
<b>D2</b>	12.7mm +/-1mm
<b>T</b>	16mm MAX

Specifications	
<b>Temperature Range:</b>	-40/+120°C
<b>Effective Frequency:</b>	10 MHz (AM Band Range) or 300 MHz (FM Band Range)

Packaging Specifications	
<b>Packaging:</b>	Tray, Box
<b>Packaging Quantity:</b>	300
<b>Weight:</b>	20 g

Statements of suitability for certain applications are based on our knowledge of typical operating conditions for such applications, but are not intended to constitute - and we specifically disclaim - any warranty concerning suitability for a specific customer application or use. This Information is intended for use only by customers who have the requisite experience and capability to determine the correct products for their application. Any technical advice inferred from this Information or otherwise provided by us with reference to the use of our products is given gratis, and we assume no obligation or liability for the advice given or results obtained.