Atmel AVR2032: ATRF231USB-RD – User Guide

8-bit Atmel Microcontrollers**Features**

- Reference design to showcase the Atmel® AT86RF231 IEEE® 802.15.4 RF transceiver/ Atmel ATSAM3S4BA MCU combination in an easy to use USB stick form factor
- Onboard external 2GByte flash memory storing a full set of documentation
- Exchangeable firmware
- Extendable for any IEEE 802.15.4 based wireless application development such as ZigBee®, 6LowPAN, ISA-100, RF4CE or any proprietary protocol
- Atmel SAM-ICE™ adapter for connecting with a JTAG programmer device
- Driver support for Windows® operating systems XP, Vista and Win7
- Default firmware:
 - Bootloader according to DFU specification, supports custom application firmware via bootloader upgrade
 - USB mass storage device

Introduction

This user guide describes the features and operation of the RF231USB Reference Design. It consists of the RF231USB radio stick and a SAM-ICE adapter.

The RF231USB radio stick represents a full functional wireless node. Device firmware can be uploaded into node's program memory from the host PC with the help of the pre-flashed bootloader application. The node may also be re-programmed via JTAG or an embedded ROM bootloader. The kit allows running mobile network applications based on plain 802.15.4, ZigBee and other network protocols.

Detailed information about the firmware, bootloader functionality and firmware update via USB and JTAG is given in the individual sections. The most recent information on the kit is always available on its toolcard website [1].

Figure 1. RF231USB-RD evaluation kit's content.



Table of Contents

1. Hardware description	3
1.1 Kit contents	3
1.2 RF231USB PCBA	3
1.3 Atmel SAM-ICE adapter	4
2. Mass storage	5
3. Pre-flashed firmware	6
3.1 USB demo application	6
3.2 First launch	6
3.3 Loopback functionality	6
3.3.1 Set up the terminal program on the PC	6
3.3.2 Run the loopback test	6
4. Driver installation	7
4.1 Driver installation in Windows XP	7
4.2 Driver installation in Windows Vista and Windows 7	10
5. Firmware update	14
5.1 USB interface bootloader (Embedded Firmware Bootloader)	14
5.1.1 Overview	14
5.1.2 Required software and its installation	14
5.1.3 Firmware update using the embedded serial bootloader	14
5.2 USB interface ROM bootloader (Embedded ROM-Bootloader / SAM-BA)	16
5.2.1 Overview	16
5.2.2 Prerequisites	17
5.2.3 Required software and installation	17
5.2.4 Firmware update using SAM-BA CDC	17
5.2.4.1 Installing device drivers enabling Atmel SAM-BA accessing the USB stick	18
5.2.4.2 Connecting SAM-BA to the USB stick	18
5.2.4.3 Transferring firmware	19
5.3 Programming using the JTAG interface	20
5.3.1 Overview	20
5.3.2 Suitable programmers	20
5.3.3 Prerequisites	20
5.3.4 Required software and installation	21
5.3.5 Firmware update using the Atmel SAM-BA	22
5.4 Restoring the devices delivery condition	22
6. Restoring the MIB	23
7. Abbreviations	24
Appendix A. EVALUATION BOARD/KIT IMPORTANT NOTICE	25
Appendix B. References	26
Appendix C. Revision History	27

1. Hardware description

1.1 Kit contents

- 1 × Atmel RF231USB PCBA kit
- 1 × Atmel SAM-ICE adapter PCBA kit
- 1 × USB extension cord
- 1 × Atmel RF231USB - Quick Start Guide

1.2 RF231USB PCBA

The compact designed RF231USB radio sticks are based on the efficient Cortex™-M3 microcontroller architecture with 256kBytes High-Speed flash and 48kBytes SRAM. Additional 2GBytes flash memory to store user defined data is provided with the RF231USB-RD; it is usable as mass storage device; furthermore board specific information and production values are stored on it.

Operating at the transmission frequency of 2.4GHz the Atmel AT86RF231 low-power transceiver [2] is integrated. It provides a complete radio transceiver interface between the antenna and the microcontroller and an extended functional range such as a 128-Bit AES hardware engine to assure data security.

To deliver status information, a basic user interface consisting of three colored and free programmable LEDs is provided on the RF231USB board. The following two photographs show its main components.

Figure 1-1. Main components RF231USB PCBA.

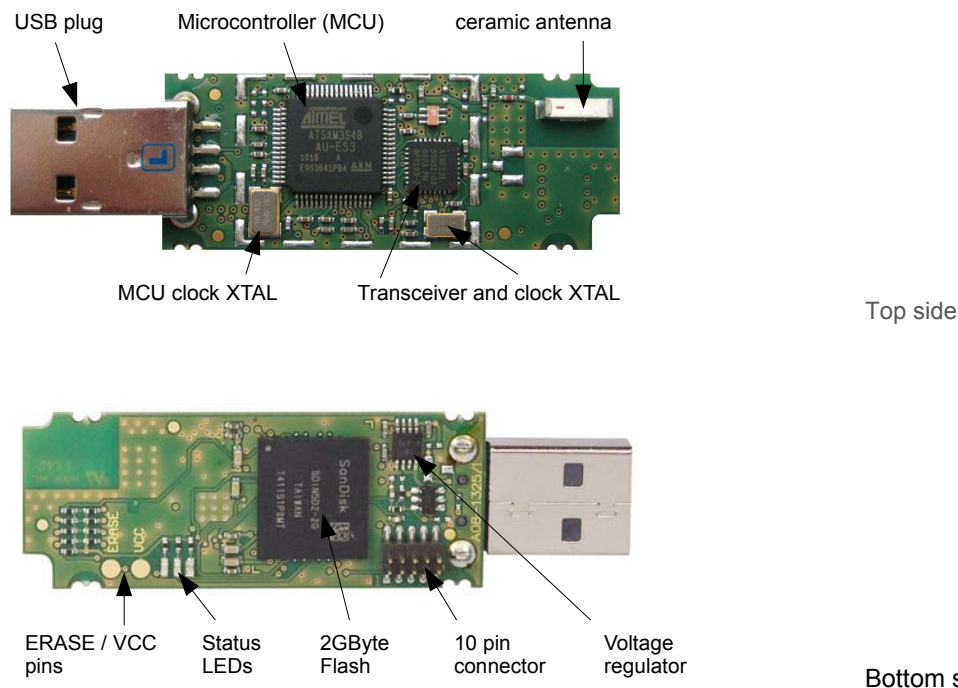

The USB radio sticks provide a programming and debugging interface to the user, by default via USB. As interface extension the SAM-ICE which is enclosed in the kit may be used. For more details please refer to the RF231USB-RD Hardware User Manual [3].

1.3 Atmel SAM-ICE adapter

The SAM-ICE adapter is designed to interface directly to an Atmel RF231USB-RD board.

Figure 1-2. Main component parts SAM-ICE adapter.

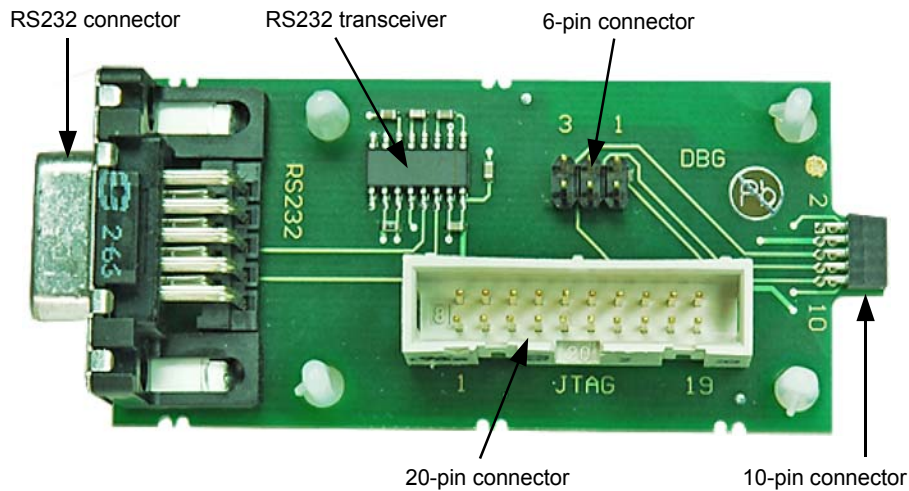

The primary physical interface for programming and debugging the RF231USB-RD board's MCU is JTAG. For programming via JTAG the RF231USB-RD board has to be attached with its JTAG connector to the SAM-ICE adapter and finally to the SAM-ICE programmer and the host PC.

The other connectors support programming, debugging and testing; on the adapter signals are converted mechanically and electrically. Via RS-232 connector the communication with the host PC can be executed; the RX and TX signals are provided V.24 compliant.

More details can be found in the SAM-ICE Adapter Hardware User Manual [\[4\]](#).

2. Mass storage

In delivery condition, the RF231 operates – besides other functionality - as a USB mass storage device. Under the Windows Operating System, shortly after plugging the stick to your PC, a respective mass storage device is automatically detected and a drive letter is assigned. Behavior under other operating systems may differ, they are not supported yet.

On the mass storage device you will find defined documentation like:

- Complete kit documentation (datasheets, manuals, application notes)
- Device drivers
- Bootloader PC-application
- Altium Design Package for MCU wireless (Altium Designer schematic symbol and PCB footprint libraries for the Atmel MCU Wireless IEEE 802.15.4 transceivers.)

The content of the mass storage device may not contain latest available documentation. Check the kit website [\[1\]](#) to download the latest information.

3. Pre-flashed firmware

3.1 USB demo application

The pre-flashed USB demo application allows using an Atmel RF231USB board, when it is attached to a USB port of a PC, as a mass-storage device.

When the user installs the drivers stored on this mass-storage device, the board is identified as a virtual COM port and a DFU device. The virtual COM port may be used by the host PC to address the board (this is demonstrated in the loop back test). The DFU device implements the firmware update functionality.

The mass-storage device also contains the bootloader PC tool, which may be used to upload application images to the board. If desired a custom DFU bootloader may be invoked. See the [Atmel AVR[®]2054: Wireless Serial Bootloader – User Guide](#) application note [5] for more information.

3.2 First launch

Attach the Atmel RF231USB-RD board to an empty USB port of your PC. The board will be identified by the PC as a mass-storage device with up to two associated 'unknown' USB devices. After enumeration the mass-storage device will end up in a new drive available.

If requested, point the system to 'drivers' folder of the drive associated with the mass-storage device to install the drivers for the board as a virtual COM port and a DFU device. Note that no additional drivers are needed to use the board as a mass-storage device. This functionality is maintained by the driver included in the pre-flashed application firmware.

The bootloader PC tool running on the host PC may be used to load new application images to the board.

Driver installation as well as firmware exchange is described in detail in the following sections.

3.3 Loopback functionality

For verifying the appropriate driver installation a simple test may be performed. It uses a virtual COM-Port on which received characters are transmitted back ("echoed").

3.3.1 Set up the terminal program on the PC

A host PC terminal program (for example: HyperTerminal) is used as a user interface to control the application running on the RF231USB-RD board connected to a PC. Set up the terminal program as follows:

BAUD RATE:	38400
PARITY:	None
DATA BITS:	8
STOP BITS:	1
FLOW CONTROL:	Off

3.3.2 Run the loopback test

1. Attach the RF231USB-RD board to a USB port on the host PC.
2. If the board does not appear as a virtual COM port in the Device Manager, double-check the driver installation.
3. In the terminal program that is set up as described above, type any character in the terminal window. The board behaves as a loop back device. Each character that is entered is received by the RF231USB-RD board and is returned to the terminal.

4. Driver installation

4.1 Driver installation in Windows XP

The first time you plug the USB stick in the “Found New Hardware Wizard” will pop up. Please select “No, not this time” and press “Next”.

Figure 4-1. Found New Hardware wizard.



On the next screen choose “Install from a list or specific location (Advanced)” and press “Next”.

Figure 4-2. Install from a specific location.

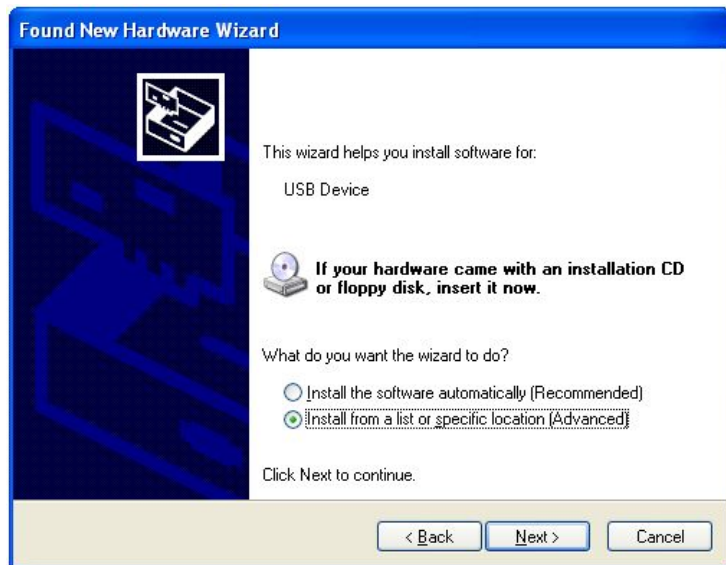

Select “Search for the best driver in these locations“, after clicking the “Browse” button point to the driver directory on the drive associated with the Atmel RF231USB’s MSD and press “Next”.

Figure 4-3. Choose driver location manually.



Windows will automatically detect the driver for the Virtual COM port. If a message box pops up warning you that the driver has not passed Windows Logo tests, confirm the driver installation by clicking “Continue Anyway”.

Figure 4-4. Confirm driver installation.

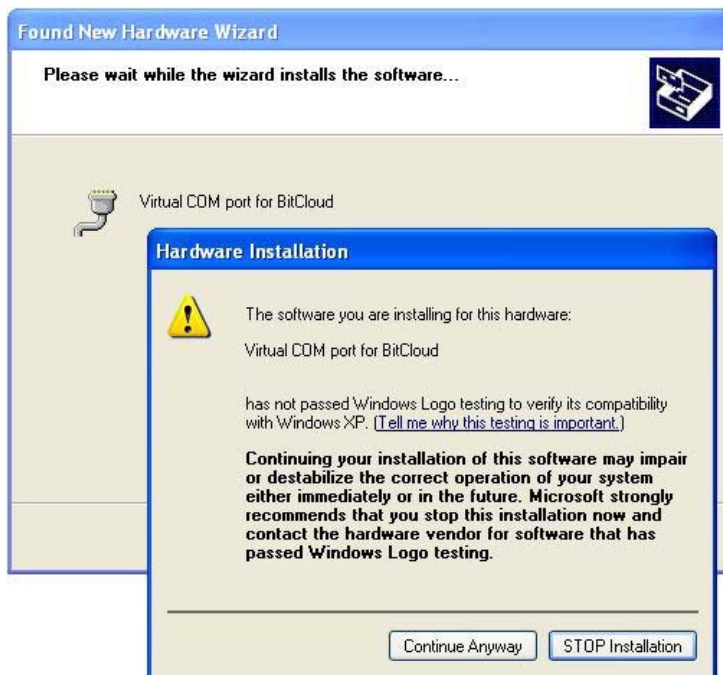

The wizard will complete the driver installation. Press “Finish” to close the window.

Figure 4-5. Finish the installation.

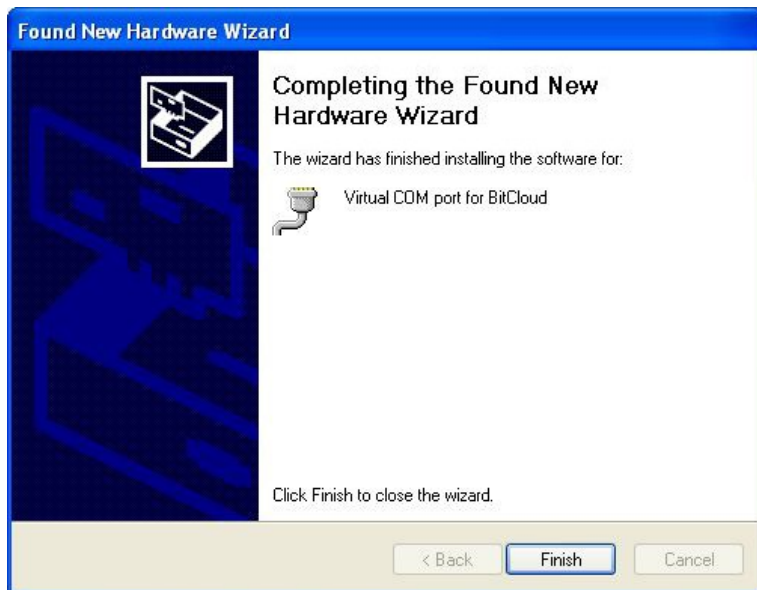

Perform the same procedure again to install the driver for the DFU device. The Mass Storage Device does not require any user interaction. After successful driver installation your device manager should show three new devices.

Figure 4-6. Successfully installed device.

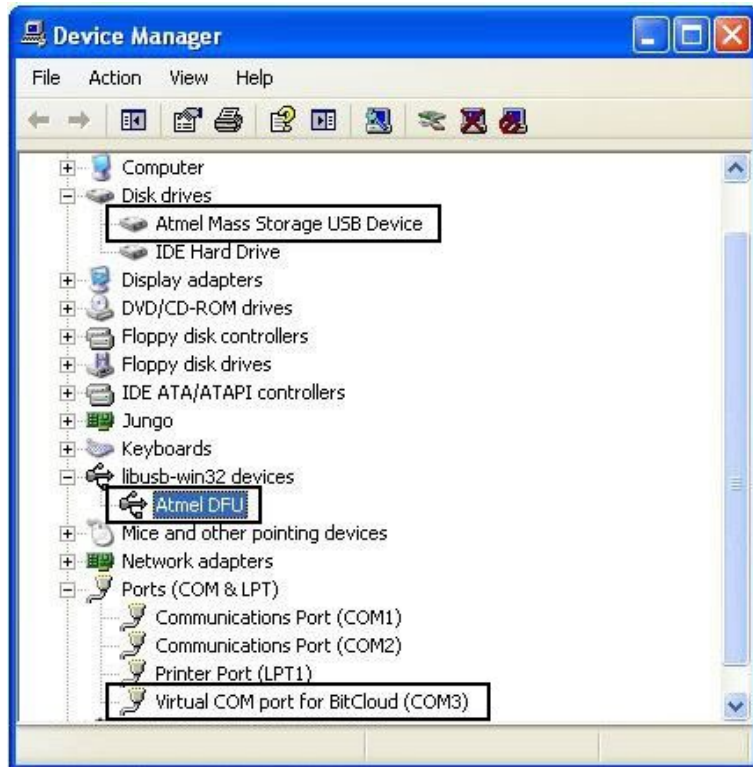

4.2 Driver installation in Windows Vista and Windows 7

If you plug in the USB stick for the first time, Windows will try to install any present driver. This will usually fail and produces the following message.

Figure 4-7. Driver not found in Win7 or Vista.

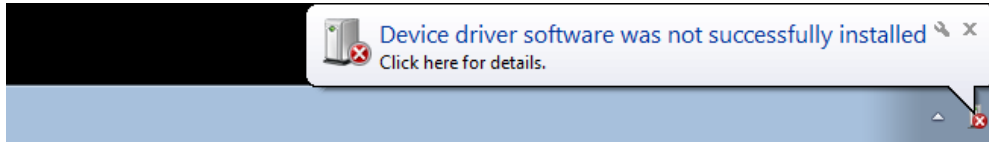

To install the correct driver please open the Device Manager (which can be found under “Control Panel | Device Manager”). Here you will find two “Unknown devices” in “Other devices”.

Figure 4-8. Driver not found in Device Manager.

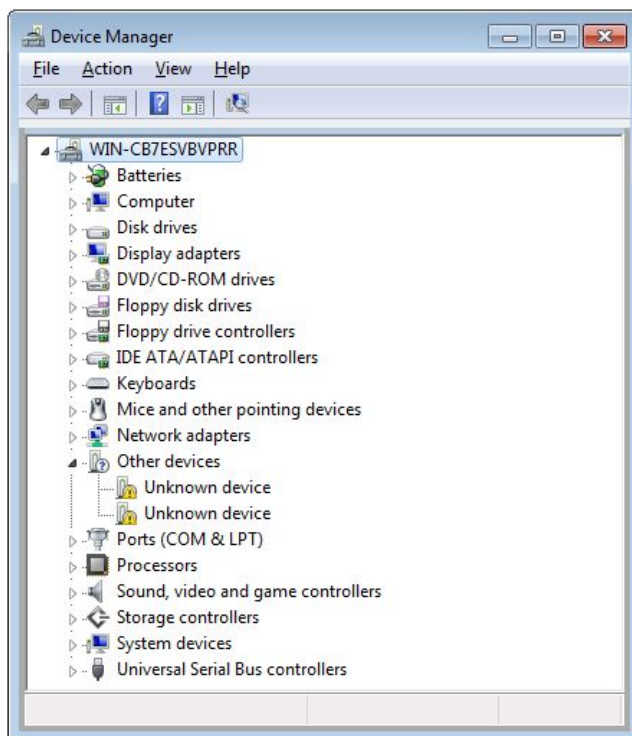

Select one of the “Unknown devices”; open the context menu with a right mouse click. Click on “Update Driver Software” in the menu.

Figure 4-9. Update driver software.

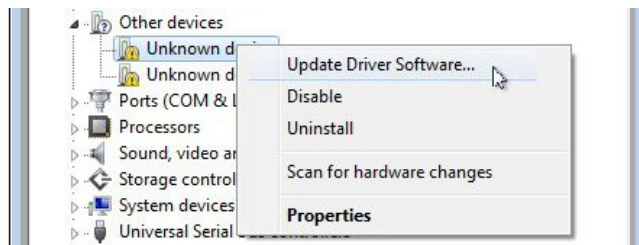

On the next dialog, choose “Browse my computer for driver software”.

Figure 4-10. Update driver software.

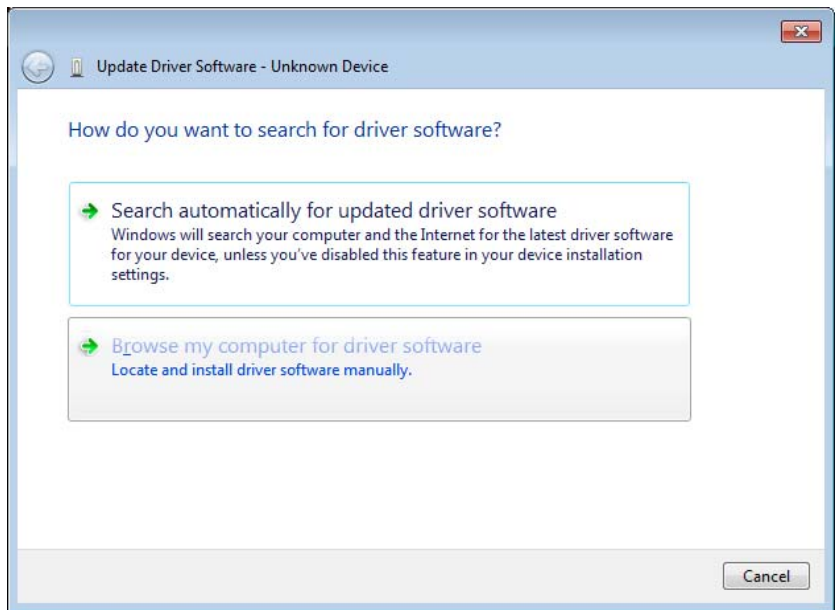

Now click “Browse...” and locate the driver directory of your Atmel RF231USB’s MSD associated drive letter.

Figure 4-11. Select driver location.

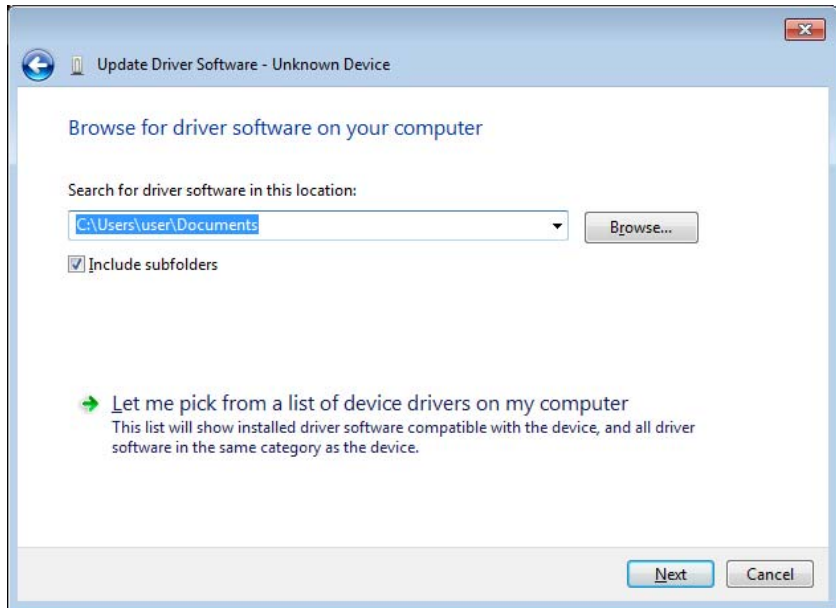
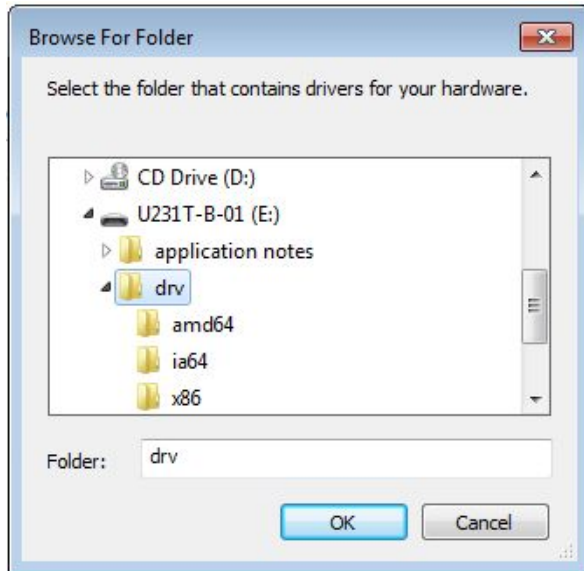

Figure 4-12. Browse for folder.



Select this directory and press “OK”. This will return to the previous dialog where “Next” starts the installation. If a Windows Security message pops up choose “Install this driver software anyway”.

Figure 4-13. Confirm driver installation.



You will see the installation progress. Close the wizard after the installation is finished by pressing “Close”.

Figure 4-14. Successful installation of the driver.

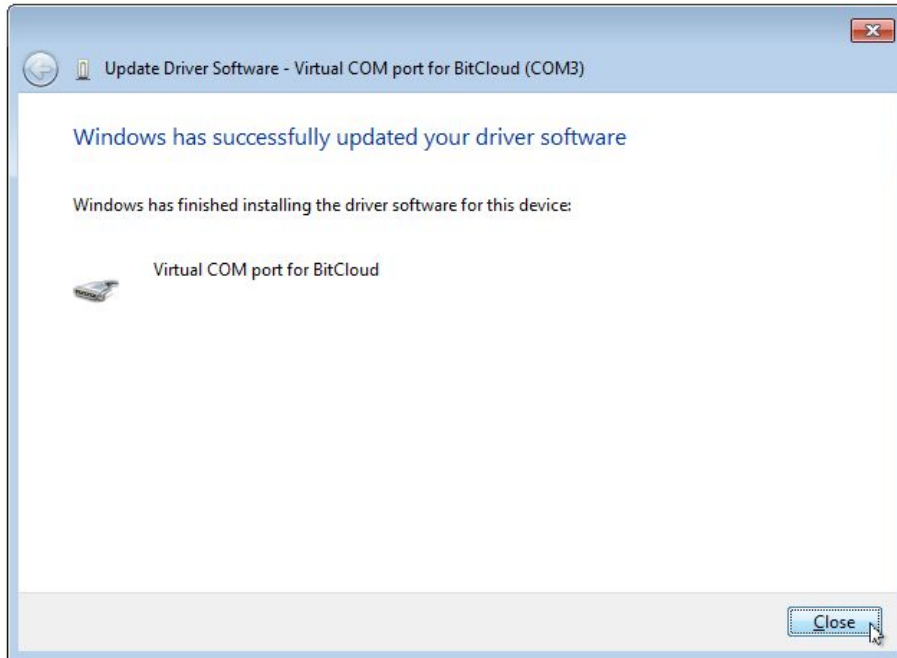

Perform the same procedure again to install the driver for the DFU device. The Mass Storage Device does not require any user interaction. After successful driver installation your device manager should show three new devices.

Figure 4-15. Device Manager: Successfully installed devices.

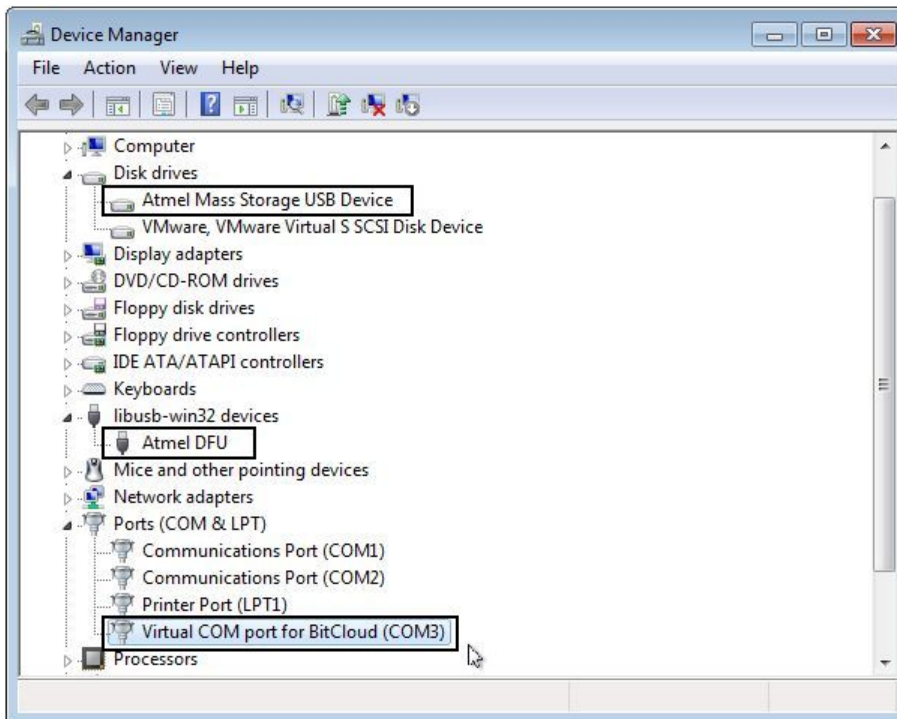

5. Firmware update

The Atmel RF231USB-RD comes pre-flashed with a bootloader firmware allowing an easy exchange of the device firmware without the need of any additional programming hardware.

A second option of updating the firmware is provided by the embedded ROM bootloader which is automatically entered when powering the device on after its MCU internal flash memory has been erased.

Finally experienced users might use the JTAG interface to support software development based on this hardware. For this purpose the kit contains an Atmel SAM-ICE adapter for interconnecting to a JTAG programmer device like the SAM-ICE. A suitable programming adapter however is not part of the RF231USB-RD kit; it is available as accessory.

5.1 USB interface bootloader (Embedded Firmware Bootloader)

5.1.1 Overview

In delivery condition the RF231USB board is equipped with a firmware containing an embedded serial bootloader. Its functionality allows uploading of application firmware through the USB connection, without the need for extra programming tools such as a dedicated JTAG programmer device. The bootloader is DFU compliant. An appropriate PC tool is used to control the embedded bootloader to load other applications to the device. Please refer to the [Atmel AVR2054](#) application note [5] or USB Device Class Specification for DFU [7] for details.

Updating the device via the bootloader requires special care to be taken: the downloaded firmware images must be provided in SREC format and demand the usage of a special linker script, otherwise the firmware will not be able to start or the embedded bootloader is no more accessible.

By erasing the device via the ERASE pin or replacing the delivery firmware via the JTAG interface, the embedded bootloader gets lost.

5.1.2 Required software and its installation

Before installing the PC-part of the bootloader application, ensure you have a Java® Runtime environment installed at least in version 1.6.0 or newer. If this does not apply, Java can be obtained from [8].

Perform the following steps to install the bootloader PC application:

1. Open an Explorer window; navigate to the drive letter associated with the RF231USB's MSD and change to the PC bootloader directory. Optionally download the latest bootloader application package from [6] and unpack the archive to your hard drive into a folder of your choice.
2. Install the bootloader tool by double-clicking the appropriate executable.
3. Navigate through the installation dialogs. It is recommended to leave all options to their default settings.

5.1.3 Firmware update using the embedded serial bootloader

To replace the RF231USB's device firmware, the bootloader PC application could be used. If you did not change this settings during setup, you shall have a start menu folder entry like "Programs | Atmel | Bootloader PC Tool". Start the tool by clicking on the "Bootloader PC Tool" entry in the respective folder. This will open a new window.

Figure 5-1. Bootloader PC Tool, main window.

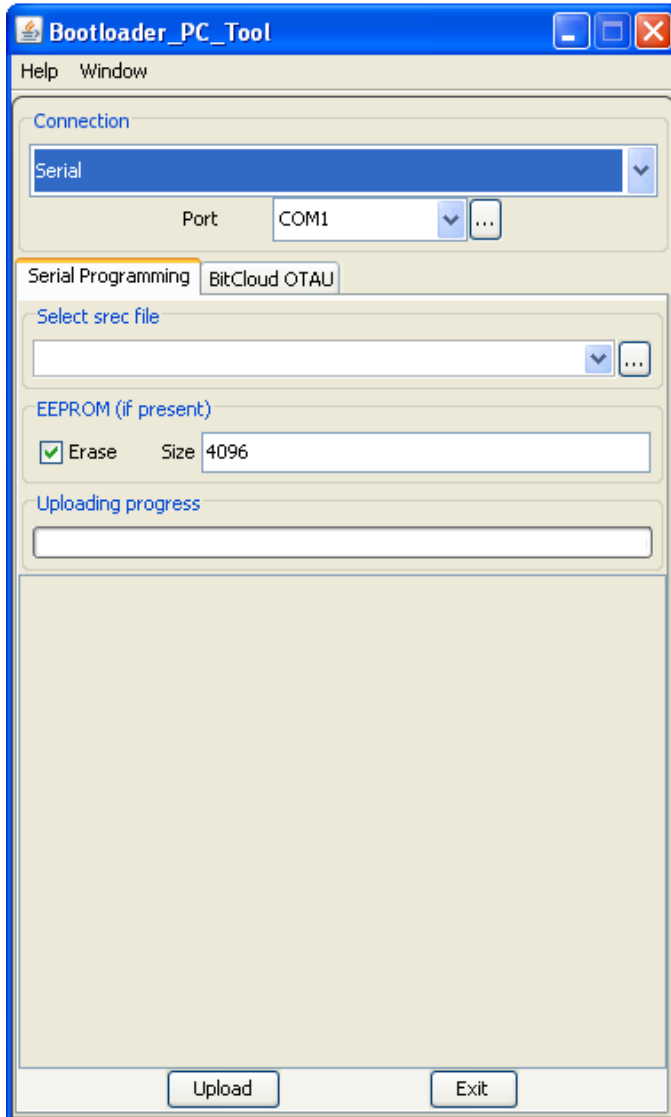

To update the Atmel RF231USB device firmware, perform as follows:

1. In the “Connection” panel, select “USB” as communication channel, the appropriate USB device can be selected by the dropdown menu below. Usually you will have only a single RF231USB connected.
2. In the “Serial Programming” tab use the Browse Button to select your device firmware file. Suitable firmware files have to be in Motorola S-REC format. Refer to the [Atmel AVR2054](#) application note [5] for details on either file format or generating such images.
3. Start uploading the firmware by clicking the “Upload” button.
4. The upload progress is indicated by the Progress bar. After the upload has finished, the device gets restarted automatically.

Figure 5-2. Device firmware upgrade steps.

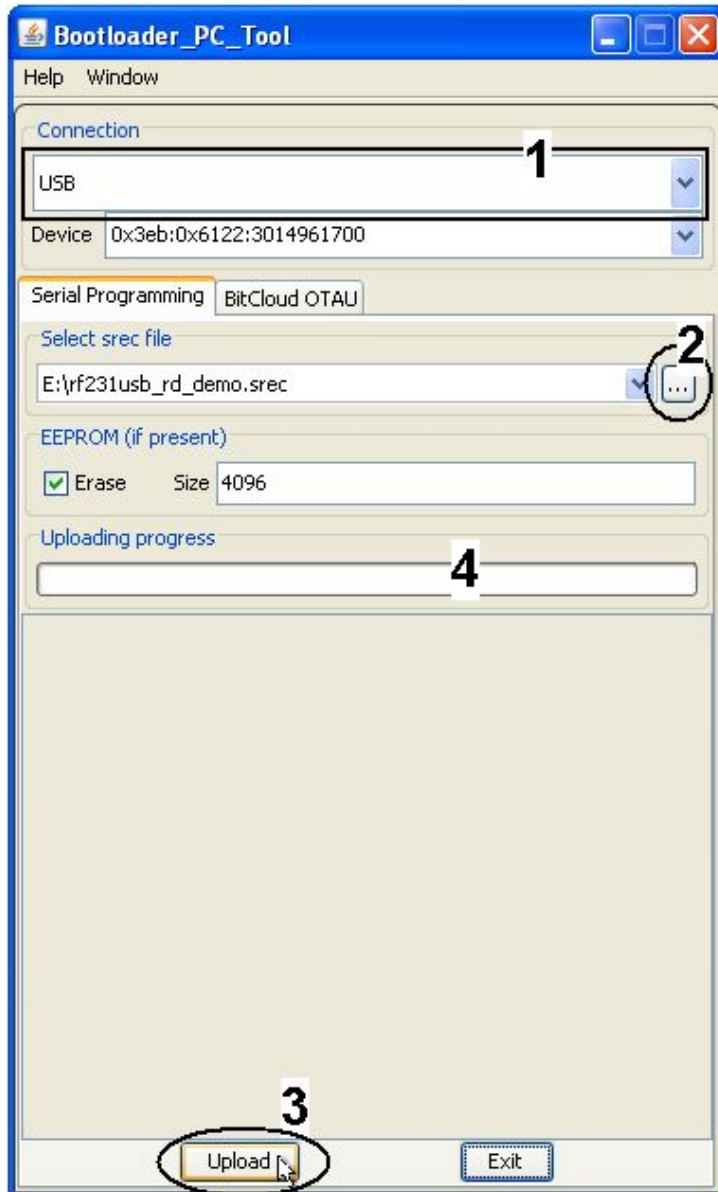

5.2 USB interface ROM bootloader (Embedded ROM-Bootloader / SAM-BA)

5.2.1 Overview

The RF231USB comes with an embedded ROM bootloader which is automatically entered during start-up of the MCU after its internal flash memory has been completely erased or at least its boot-mode selection bit GPNVM1 has been cleared. Just like the embedded firmware bootloader, the ROM bootloader uses the USB-interface and operates a virtual COM-Port for firmware transfer. Refer to the [Atmel SAM3S Series User Manual \[9\]](#) for details.

Note: It is strongly recommended whenever it becomes necessary to upgrade the Atmel RF231USB board firmware to use the embedded firmware serial bootloader preferably (see previous section). Anyhow the alternate ways as described in the following sections could become necessary if, for example, the firmware the device was shipped with has become inaccessible.

5.2.2 Prerequisites

Using the USB interface ROM bootloader requires executing one of the following actions first:

- Erasing the device - either via the JTAG interface or the CDC interface using a suitable software or
- Clearing the GPNVM bit 1 - either by firmware or by JTAG or
- Tying the ERASE pad to V_{CC} for at least 220ms (Plug the stick into an USB port first. While being powered, shortcut the two metal contacts on the bottom side of the printed circuit board, see [Figure 5-3](#))

Figure 5-3. Bottom side RF231USB-RD, erase pad marked.



Note: During the erase procedure all data stored in the MCU flash of the USB stick are deleted! However the data in its external flash is not affected.

5.2.3 Required software and installation

Accessing the ROM bootloader requires the Atmel SAM-BA[®] In-System-Programmer tool [10] on the PC side. Starting with version 2.12, it supports the Atmel RF231USB devices.

1. Download the Atmel SAM-BA setup file from its website.
2. Install SAM-BA by following the instructions given in the installation routine, whenever you are unsure with any settings, use the recommended defaults.

Figure 5-4. SAM-BA installation.

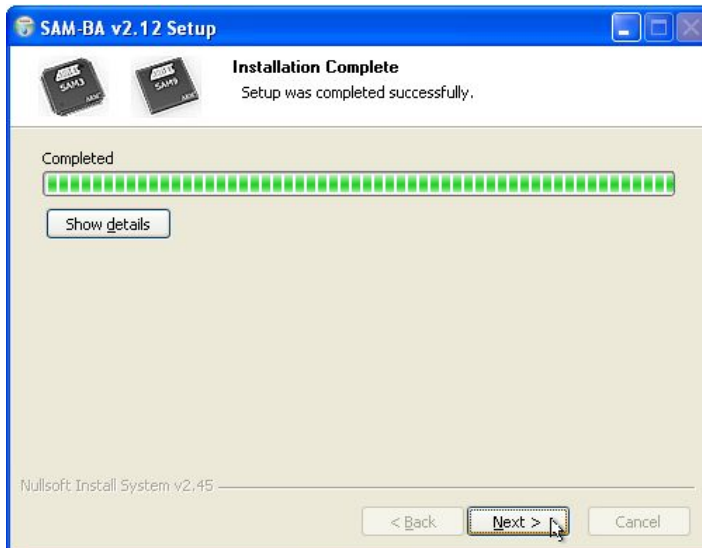

5.2.4 Firmware update using SAM-BA CDC

In this section we will describe how to update the RF231USB device firmware with SAM-BA in CDC mode. We showcase this by the example of the restoring shipping firmware. It is assumed that SAM-BA has been successfully installed previously and the device has been erased (see [Section 5.2.2](#)).

5.2.4.1 Installing device drivers enabling Atmel SAM-BA accessing the USB stick

Power-cycle the Atmel RF231USB device by disconnecting it from the USB port and replugging it. This starts up the embedded ROM bootloader. Your PC will prompt for a driver on Windows XP or will fail to find a suitable driver for Windows Vista® and Win7 editions. Depending on your operating system perform similarly to the steps described in Chapter 4. In contrast suitable device drivers are to be found in the “drv” subdirectory of the directory containing your SAM-BA installation. Only one single driver has to be installed. Afterwards, in the device manager, the device will be identified as “AT91 USB to Serial Converter” in the “Ports (COM & LPT)” section.

Figure 5-5. Device Manager after successful driver installation.

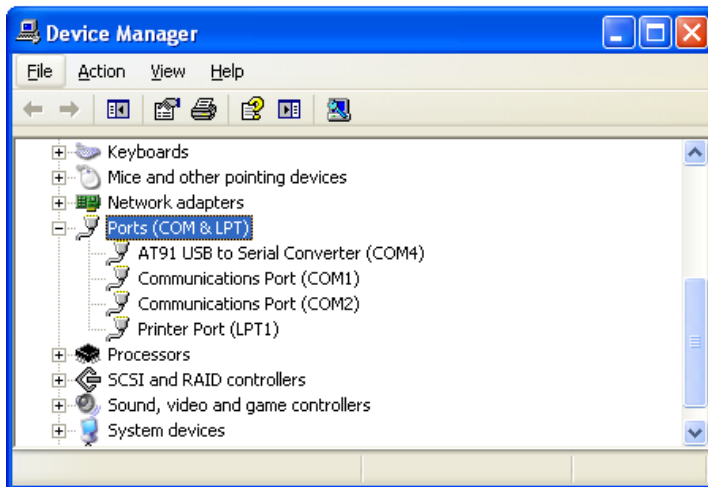

5.2.4.2 Connecting SAM-BA to the USB stick

Start SAM-BA. Depending on your installation, the short-cut may be found either on the desktop or in the start menu. SAM-BA will scan your COM ports and presents a selection dialog for the connection and the platform. Select the COM port of the RF231USB stick to update. You will find its number in the Device Manager. As second step, select the platform which must be “RF231USB”. Having connection and board type selected, press “Connect”.

Figure 5-6. Connect to the USB stick.

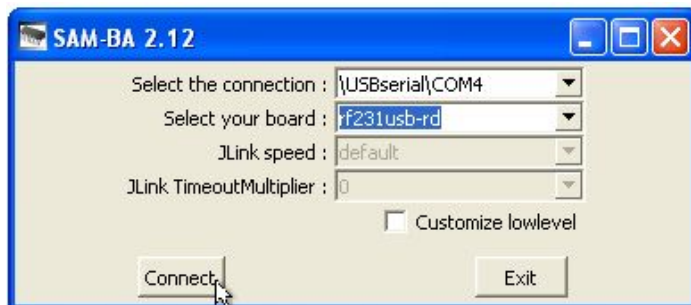

SAM-BA now tries to connect to the USB stick. This can take some seconds. Finally a dialog window opens giving access to all the memories of the microcontroller.

5.2.4.3 Transferring firmware

To transfer a new firmware to the USB stick you have to select the image file first. This file must be in binary (BIN) format. No other formats will be accepted. To select a firmware file press the button marked with (1) in Figure 5-7. A file dialog will pop up and lets you locate and select the file to upload. After you selected the file press “Send File” (2). Your file will be transferred. At the end the Atmel SAM-BA will ask you if you want to lock the flash. This is not necessary; you can omit it by pressing “No”.

Note: In case you like to restore the Atmel RF231USB delivery firmware, the required binary image can be downloaded from the kit toolcard [1].

Figure 5-7. SAM-BA GUI.

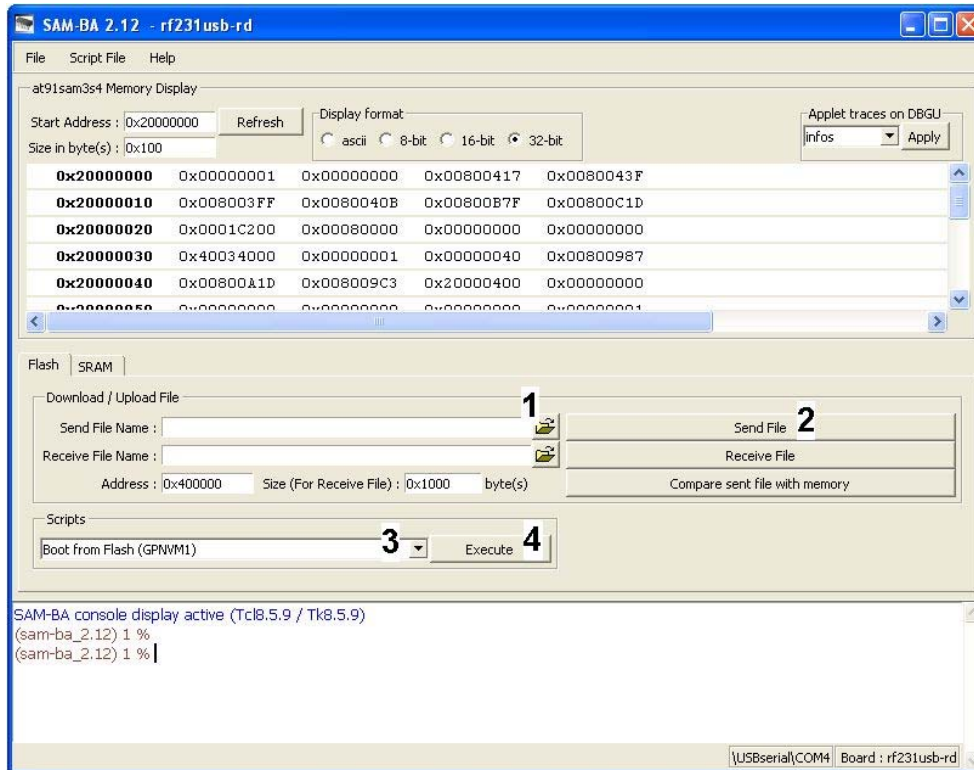
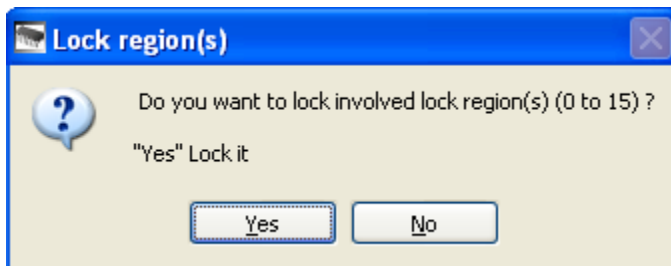

Figure 5-8. Lock regions.



One final step needs to be executed. Your USB radio stick is still in SAM-BA mode and you have to change the Boot Mode to let the USB stick start your firmware. This can be achieved by executing a script from the “Scripts” drop-down box.

To select the correct script open the drop-down box (3) and select the entry “Boot from Flash (GPNVM1)”. Execute the script by pressing “Execute” (4).

Now the update is finished. Close the Atmel SAM-BA and unplug the USB stick. The next time you connect the USB stick to a USB port your just uploaded firmware will be started.

5.3 Programming using the JTAG interface

5.3.1 Overview

The Atmel RF231USB's Header X2 provides JTAG access of the Atmel SAM3 MCU through the four-pin JTAG interface (TDI, TDO, TCK, TMS) with a JTAG-programmer suitable for ARM[®]-based microcontrollers. Since the traditional JTAG interface for ARM MCUs is a 20-pin 100mil connector the Atmel SAM-ICE adapter converts the signals available on X2 mechanically and electrically to this standard JTAG interface.

Figure 5-9 shows RF231USB stick connected to the SAM-ICE adapter. Details of the SAM-ICE adapter can be found in [4].

Figure 5-9. SAM-ICE adapter PCBA connected to the RF231USB PCBA.

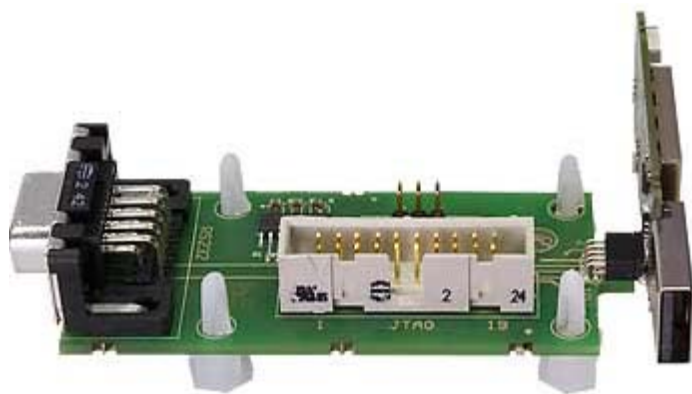

5.3.2 Suitable programmers

Using the JTAG interface two main programmer main alternatives can be chosen:

- Segger J-Link or Atmel SAM-ICE
- OpenOCD compatible programmer

Segger J-Link or Atmel SAM-ICE

These In-Circuit-Emulators are commercially available programming adapters. They work well with the SAM-BA In-System-Programmer tool, as well as with commercially available developing environments, for example, the IAR Embedded Workbench[®]. They are also working with the GDB debug server (for use with open source toolchain). The programming and debugging features are license dependent. All following explanations assume you are using the Atmel SAM-ICE programmer [11].

OpenOCD

An optional on-chip debug system including flash programming and SRAM debugging support is available from various vendors; see Appendix B – References, [13], for an example. This solution is recommended for open source toolchains. Since Atmel does not support this option, it will not be described further.

5.3.3 Prerequisites

For the RF231USB stick, no special erasing procedure is required in prior.

Follow the steps below to assemble the required hardware:

1. Connect the Atmel RF231USB board with its JTAG connector to the Atmel SAM-ICE adapter.
2. Connect the Atmel SAM-ICE programmer to the 20-pin-connector, X2, of the SAM-ICE adapter and via USB cable to the host PC.
3. Attach the RF231USB-RD board (connected to the SAM-ICE adapter) to the PC's USB, preferably using the USB extension cord enclosed in the kit.
4. Optionally connect the SAM-ICE adapter's RS-232 connector to the host PC. The required cable is not part of the present kit delivery.

Figure 5-10 and Figure 5-11 shows how the assembly is done and the hardware schematic.

Figure 5-10. SAM-ICE adapter with programmer and USB radio stick (left-hand).

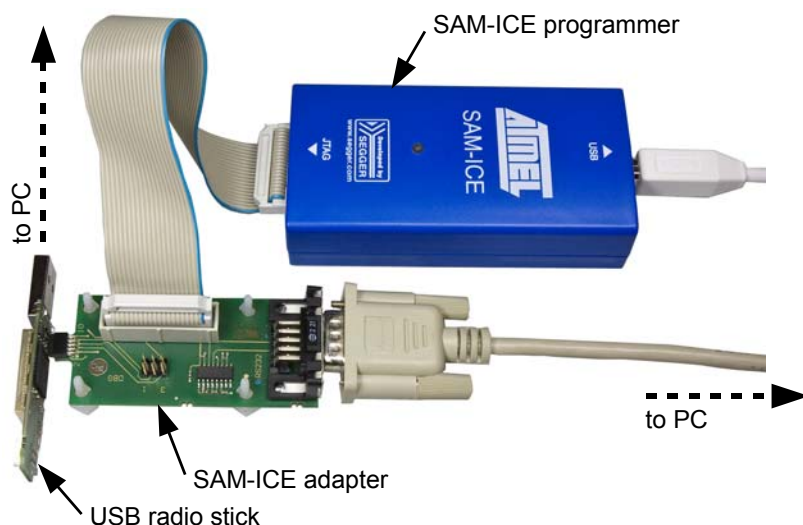
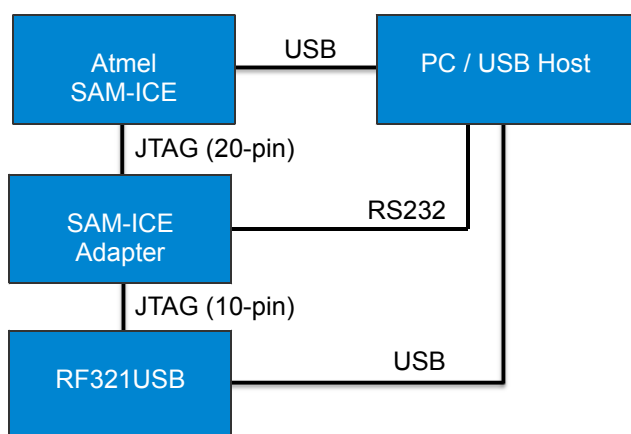

Figure 5-11. Hardware setup schematic.



For the SAM-ICE programmer, special device drivers have to be installed. Refer to the SAM-ICE User Guide [12], Chapter 3, how to do that.

5.3.4 Required software and installation

It is suggested to use the Atmel SAM-BA [10] for firmware update. The software has to be installed like explained in Section 5.2.3.

5.3.5 Firmware update using the Atmel SAM-BA

Updating the device firmware using the JTAG interface over the Atmel SAM-ICE programmer is very similar to the descriptions in Section 5.2.4. However, instead of selecting a virtual COM-port, use “\jlink\ARM0” as connection type.

5.4 Restoring the devices delivery condition

In case you accidentally erased the Atmel RF231USB devices firmware, the embedded serial bootloader will not function any more. Also the MSD which contained a copy of the firmware image in its delivery condition is no more accessible.

Anyhow the firmware image is still available through the kit website [13]. For the restoration procedure, follow the instructions given in Section 5.2 when using the ROM bootloader or from Section 5.3 if you have an appropriate JTAG programming adapter available.

6. Restoring the MIB

The Atmel RF231USB's onboard 2GB Flash memory contains a special memory stack in which board information data (for example, MAC_Address) are stored. Please refer to the Atmel RF231USB HW User Manual [\[3\]](#) for details.

In delivery condition, the shipping firmware avoids that this part of flash is used as mass storage such that it is impossible to destroy the board information data. If implementing custom access to the flash using the eMMC interface, avoid writing to its uppermost memory block.

Note: Work carefully, pay special attention and check your code twice.

Besides static data like MAC-address, the MIB also contains dynamically generated content like calibration values and the data; therefore is protected by a checksum. Board information data cannot simply be restored by the end customer. Please contact support, if required.

7. Abbreviations

802.15.4	-	IEEE 802.15.4-2003 standard, applicable to low-rate wireless personal area network
AES	-	Advanced encryption standard
ASF	-	Application software framework
CDC	-	Communication device class
COM	-	Serial port interface on IBM PC-compatible computers, can refer to physical and virtual ports
CRC	-	Cyclic redundancy check
DFU	-	Device firmware upgrade
eMMC	-	Embedded MultiMediaCard, architecture of an embedded storage solution with MMC interface, flash memory, controller
ETSI	-	European Telecommunications Standards Institute
FCC	-	Federal Communications Commission
GPNVM	-	General Purpose non-volatile memory (bit; the SAM3S features two GPNVM bits)
GUI	-	Graphical user interface
ICE	-	In-circuit-emulator
JTAG	-	Digital interface for debugging of embedded device, also known as IEEE 1149.1 standard interface
MAC	-	Medium access control
MCU	-	Microcontroller unit
MIB	-	Management Information Base
MSD	-	Mass storage device
PCB	-	Printed circuit board
PCBA	-	Printed circuit board assembly
RS-232	-	Traditional name of standards for serial binary data and control signals commonly used in computer serial ports
RX	-	Receiver
SAM-BA	-	SAM boot assistant
SRAM	-	Static random access memory
TX	-	Transmitter
U(S)ART	-	Universal (synchronous) asynchronous receiver/transmitter
USB	-	Universal Serial Bus
V.24	-	A standard similar to RS-232
WPAN	-	Wireless personal area network
ZigBee	-	Wireless networking standard targeted at low-power applications

Appendix A. EVALUATION BOARD/KIT IMPORTANT NOTICE

This evaluation board/kit is intended for use for **FURTHER ENGINEERING, DEVELOPMENT, DEMONSTRATION, OR EVALUATION PURPOSES ONLY**. It is not a finished product and may not (yet) comply with some or any technical or legal requirements that are applicable to finished products, including, without limitation, directives regarding electromagnetic compatibility, recycling (WEEE), FCC, CE or UL (except as may be otherwise noted on the board/kit). Atmel supplied this board/kit "AS IS," without any warranties, with all faults, at the buyer's and further users' sole risk. The user assumes all responsibility and liability for proper and safe handling of the goods. Further, the user indemnifies Atmel from all claims arising from the handling or use of the goods. Due to the open construction of the product, it is the user's responsibility to take any and all appropriate precautions with regard to electrostatic discharge and any other technical or legal concerns.

EXCEPT TO THE EXTENT OF THE INDEMNITY SET FORTH ABOVE, NEITHER USER NOR ATMEL SHALL BE LIABLE TO EACH OTHER FOR ANY INDIRECT, SPECIAL, INCIDENTAL, OR CONSEQUENTIAL DAMAGES.

No license is granted under any patent right or other intellectual property right of Atmel covering or relating to any machine, process, or combination in which such Atmel products or services might be or are used.

Mailing Address: Atmel Corporation, 2325 Orchard Parkway, San Jose, CA 95131

Copyright © 2012, Atmel Corporation

Appendix B. References

- [1]. Atmel ATRF231USB-RD toolcard
<http://www.atmel.com/tools/RF231USB-RD.aspx>
- [2]. AT86RF231; Low Power, 2.4GHz Transceiver for ZigBee, IEEE 802.15.4, 6LoWPAN, RF4CE, SP100, WirelessHART and ISM Applications; Datasheet; Rev. 8111B-MCU Wireless-02/09; Atmel Corporation <http://www.atmel.com/Images/doc8111.pdf>
- [3]. AVR2030: ATRF231USB - Hardware User Manual – August 2012; Atmel Corporation <http://www.atmel.com/tools/RF231USB-RD.aspx?tab=documents>
- [4]. AVR2033: SAM-ICE Adapter - Hardware User Manual – August 2012; Atmel Corporation <http://www.atmel.com/tools/RF231USB-RD.aspx?tab=related>
- [5]. AVR2054: Serial Bootloader User Guide
<http://www.atmel.com/Images/doc8390.pdf>
- [6]. AVR2054: Serial Bootloader Application Note package
<http://www.atmel.com/Images/AVR2054.zip>
- [7]. Universal Serial Bus Device Class Specification for Device Firmware Upgrade http://www.usb.org/developers/devclass_docs/usbfu10.pdf
- [8]. Java SE Download
<http://www.java.com/download>
- [9]. AT91SAM ARM-based Flash MCU, SAM3S Series, preliminary datasheet, doc. no. 6500; Atmel Corporation. Downloadable from:
<http://www.atmel.com/Images/doc6500.pdf>
- [10]. Atmel SAM-BA In-system Programmer
<http://www.atmel.com/tools/ATMELSAM-BAIN-SYSTEMPROGRAMMER.aspx>
- [11]. Atmel AT91SAM-ICE™ JTAG emulator
<http://www.atmel.com/tools/ATMELSAM-ICE.aspx>
- [12]. Atmel AT91SAM-ICE User Guide
<http://www.atmel.com/Images/doc6206.pdf>
- [13]. Olimex OpenOCD Open Source ARM debugger
<http://www.olimex.com/dev/arm-usb-ocd.html>

Appendix C. Revision History

Doc. Rev.	Date	Comments
42022A	09/2012	Initial document release

**Atmel Corporation**

2325 Orchard Parkway
San Jose, CA 95131
USA

Tel: (+1)(408) 441-0311

Fax: (+1)(408) 487-2600

www.atmel.com

Atmel Asia Limited

Unit 01-5 & 16, 19F
BEA Tower, Millennium City 5
418 Kwun Tong Road

Kwun Tong, Kowloon

HONG KONG

Tel: (+852) 2245-6100

Fax: (+852) 2722-1369

Atmel Munich GmbH

Business Campus
Parkring 4
D-85748 Garching b. Munich
GERMANY

Tel: (+49) 89-31970-0

Fax: (+49) 89-3194621

Atmel Japan G.K.

16F Shin-Osaki Kangyo Building
1-6-4 Osaki
Shinagawa-ku, Tokyo 141-0032
JAPAN

Tel: (+81)(3) 6417-0300

Fax: (+81)(3) 6417-0370

© 2012 Atmel Corporation. All rights reserved. / Rev.: 42022A-AVR-09/2012

Atmel®, Atmel logo and combinations thereof, AVR®, Enabling Unlimited Possibilities®, SAM-BA®, and others are registered trademarks or trademarks of Atmel Corporation or its subsidiaries. Windows® is a registered trademark of Microsoft Corporation in U.S. and other countries. ARM® is a registered trademark of ARM Ltd. Other terms and product names may be trademarks of others.

Disclaimer: The information in this document is provided in connection with Atmel products. No license, express or implied, by estoppel or otherwise, to any intellectual property right is granted by this document or in connection with the sale of Atmel products. EXCEPT AS SET FORTH IN THE ATMEL TERMS AND CONDITIONS OF SALES LOCATED ON THE ATMEL WEBSITE, ATMEL ASSUMES NO LIABILITY WHATSOEVER AND DISCLAIMS ANY EXPRESS, IMPLIED OR STATUTORY WARRANTY RELATING TO ITS PRODUCTS INCLUDING, BUT NOT LIMITED TO, THE IMPLIED WARRANTY OF MERCHANTABILITY, FITNESS FOR A PARTICULAR PURPOSE, OR NON-INFRINGEMENT. IN NO EVENT SHALL ATMEL BE LIABLE FOR ANY DIRECT, INDIRECT, CONSEQUENTIAL, PUNITIVE, SPECIAL OR INCIDENTAL DAMAGES (INCLUDING, WITHOUT LIMITATION, DAMAGES FOR LOSS AND PROFITS, BUSINESS INTERRUPTION, OR LOSS OF INFORMATION) ARISING OUT OF THE USE OR INABILITY TO USE THIS DOCUMENT, EVEN IF ATMEL HAS BEEN ADVISED OF THE POSSIBILITY OF SUCH DAMAGES. Atmel makes no representations or warranties with respect to the accuracy or completeness of the contents of this document and reserves the right to make changes to specifications and products descriptions at any time without notice. Atmel does not make any commitment to update the information contained herein. Unless specifically provided otherwise, Atmel products are not suitable for, and shall not be used in, automotive applications. Atmel products are not intended, authorized, or warranted for use as components in applications intended to support or sustain life.