

DESCRIPTION

The MP3393 is a step-up controller with 8 current channel sources designed to power WLED backlights for large LCD panels.

The MP3393 uses current-mode fixed-frequency architecture. It drives an external MOSFET to boost the output voltage. The switching frequency is programmable by an external setting resistor.

The MP3393 integrates a constant-current control circuit to regulate the current in each LED string to the value set by an external current feedback resistor. Current matching can achieve 1.2% regulation accuracy between strings. Its low 202mV regulation voltage reduces power loss and improves efficiency.

The MP3393 includes protections including under-voltage lockout, LED open/short protection, and thermal shutdown. The fault flag pin indicates the statuses of all fault signals.

The MP3393 can be daisy-chained to expand the number of LED channels. It is available in TSSOP28EP and SOIC28 packages.

FEATURES

- 9V-to-32V Input Voltage Range
- Drives 8 Channels of LED strings
- Internal Constant-Current Control
- Maximum Channel Current Over 350mA
- 1.2% Current Matching Accuracy Between Strings
- Programmable Switching Frequency
- Analog Dimming and External PWM Dimming
- Open and Short LED Protection
- Programmable Over-Voltage Protection
- Fault Output Flag
- Thermal Shutdown
- Extendable LED Channels that Share One Power Stage Set
- TSSOP28EP and SOIC28 Packages

APPLICATIONS

- Flat Panel Video Displays
- LCD TVs and Monitors

All MPS parts are lead-free and adhere to the RoHS directive. For MPS green status, please visit MPS website under Quality Assurance.

"MPS" and "The Future of Analog IC Technology" are Registered Trademarks of Monolithic Power Systems, Inc.

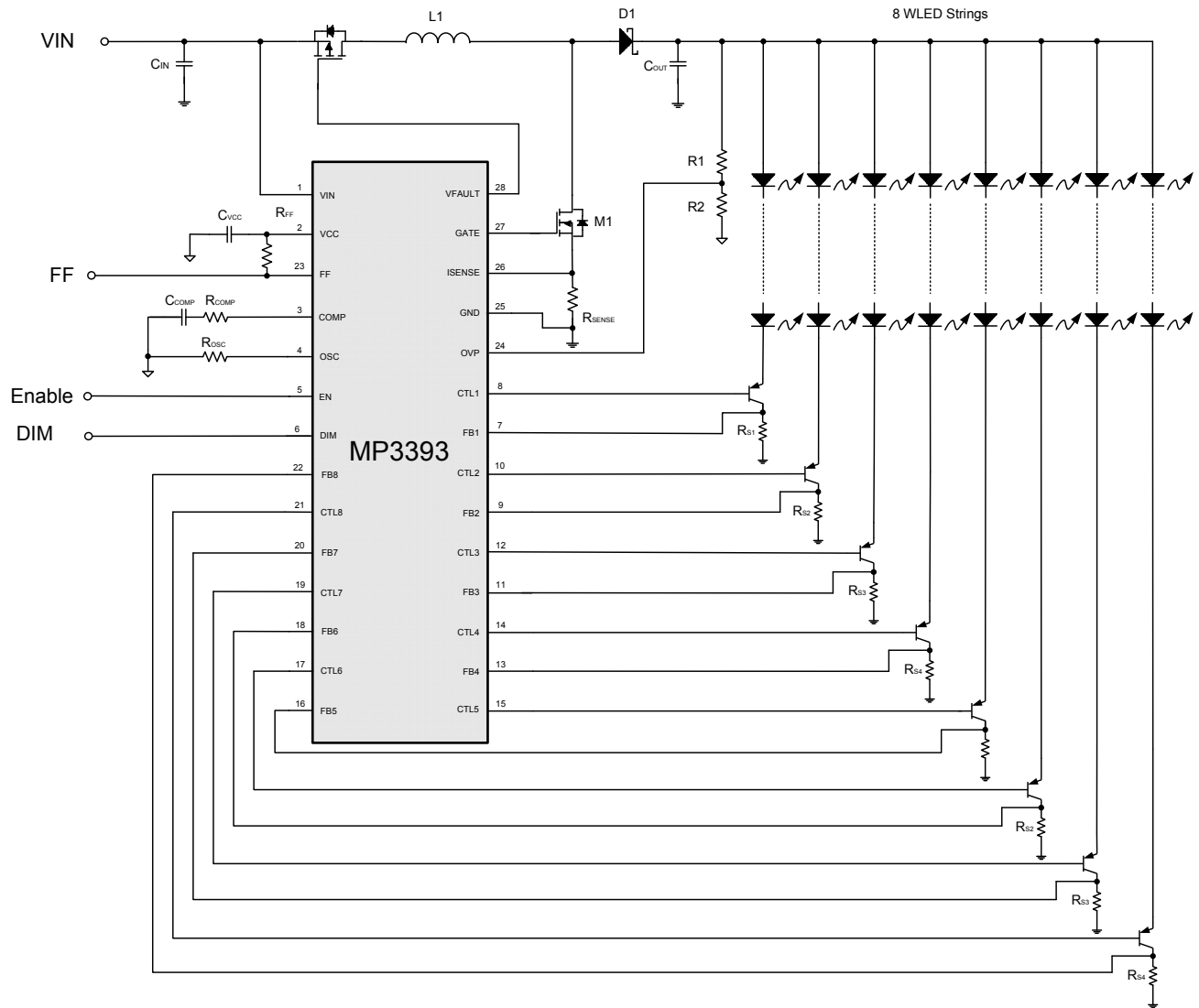
TYPICAL APPLICATION

ORDERING INFORMATION

Part Number	Package	Top Marking
MP3393EF	TSSOP28EP	MP3393
MP3393EY	SOIC28	MP3393

*For Tape & Reel, add suffix -Z (eg. MP3393EF-Z).

For RoHS, compliant packaging, add suffix -LF (e.g. MP3393EF-LF-Z).

**For Tape & Reel, add suffix -Z (eg. MP3393EY-Z).

For RoHS, compliant packaging, add suffix -LF (e.g. MP3393EY-LF-Z).

PACKAGE REFERENCE

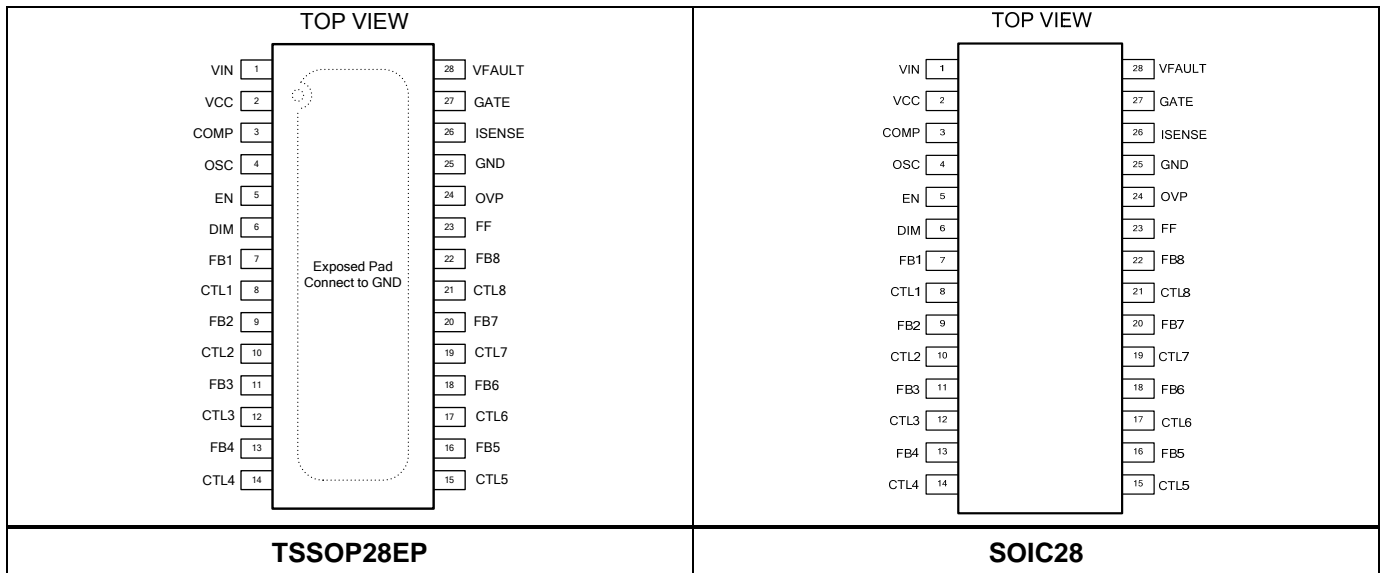

ABSOLUTE MAXIMUM RATINGS ⁽¹⁾

V_{IN}, V_{FAULT}	-0.3V to 35V
V_{GATE}	-0.5V to 13V
V_{CC}	-0.5V to 13V
V_{CTL1} to V_{CTL8}	58V
All Other Pins.....	-0.3V to +6.3V
Continuous Power Dissipation ($T_A = +25^{\circ}C$) ⁽²⁾	
TSSOP28EP.....	3.9 W
SOIC28.....	2.1W
Junction Temperature.....	150°C
Lead Temperature.....	260°C
Storage Temperature.....	-65°C to +150°C

Recommended Operating Conditions ⁽³⁾

Supply Voltage V_{IN}	9V to 32V
LED Current (Backlight).....	50mA to 300mA
Operating Junction Temp (T_J)..	-40°C to +125°C

Thermal Resistance ⁽⁴⁾ θ_{JA} θ_{JC}

TSSOP28EP.....	32	6	°C/W
SOIC28.....	60	30	°C/W

Notes:

- Exceeding these ratings may damage the device.
- The maximum allowable power dissipation is a function of the maximum junction temperature T_J (MAX), the junction-to-ambient thermal resistance θ_{JA} , and the ambient temperature T_A . The maximum allowable continuous power dissipation at any ambient temperature is calculated by P_D (MAX) = $(T_J$ (MAX)- T_A)/ θ_{JA} . Exceeding the maximum allowable power dissipation will cause excessive die temperature, and the regulator will go into thermal shutdown. Internal thermal shutdown circuitry protects the device from permanent damage.
- The device is not guaranteed to function outside of its operation conditions.
- Measured on JESD51-7, 4-layer PCB.

ELECTRICAL CHARACTERISTICS

$V_{IN} = 12V$, $V_{EN} = 5V$, $T_A = +25^{\circ}C$, unless otherwise noted.

Parameters	Symbol	Condition	Min	Typ	Max	Units
Operating Input Voltage	V_{IN}		9		32	V
Supply Current (Quiescent)	I_Q	$V_{IN}=12V$, $V_{EN}=5V$, no load with switching		3		mA
Supply Current (Shutdown)	I_{ST}	$V_{EN}=0V$, $V_{IN}=12V$			2	μA
LDO Output Voltage	V_{CC}	$V_{EN}=5V$, $11V < V_{IN} < 32V$, $0 < I_{VCC} < 10mA$	9	10	11	V
Input UVLO Threshold	V_{IN_UVLO}	Rising Edge	7.5	8	8.5	V
Input UVLO Hysteresis				400		mV
EN High Voltage	V_{EN_HIGH}		1.85			V
EN Low Voltage	V_{EN_LOW}				0.6	V
STEP-UP CONVERTER						
Gate Driver Impedance (Sourcing)		$V_{CC}=10V$, $V_{GATE}=10V$		4		Ω
Gate Driver Impedance (Sinking)		$V_{CC}=10V$, $I_{GATE}=10mA$		2		Ω
GATE Voltage	V_{GATE}	$11V < V_{IN} < 32V$		10		V
Switching Frequency	f_{SW}	$R_{OSC} = 115k\Omega$	120	140	160	kHz
OSC Voltage	V_{OSC}		1.18	1.23	1.28	V
Minimum On Time	t_{ON_MIN}	PWM Mode, with no pulse-skipping		100		ns
Maximum Duty Cycle	D_{MAX}		90			%
ISENSE Limit		Max. Duty Cycle	135	170	205	mV
CTLx Regulation Voltage	V_{CTL}			320		mV
CTLx Maximum Sink Current	I_{CTL}		5.5	9.5	13.5	mA
COMP Source Current Limit	I_{COMP_SOL}			65		μA
COMP Sink Current Limit	I_{COMP_SIL}			8		μA
PWM DIMMING						
Minimum Dimming Threshold	V_{DIM_MIN}			0.4		V
Maximum Dimming Threshold	V_{DIM_MAX}			1.5		V
LED CURRENT REGULATION						
FBX Regulation Average Voltage	V_{FBX}		195	202	209	mV
FBX Regulation Voltage matching				1.0	1.2	%

ELECTRICAL CHARACTERISTICS *(continued)*
 $V_{IN} = 12V$, $V_{EN} = 5V$, $T_A = +25^{\circ}C$, unless otherwise noted.

Parameters	Symbol	Condition	Min	Typ	Max	Units
PROTECTION						
OVP Over Voltage Threshold	V_{OVP_OV}	Rising Edge	1.20	1.23	1.26	V
OVP UVLO threshold	V_{OVP_UV}	Step-up Converter Fails	50	70	90	mV
CTLx UVLO Threshold	V_{CTL_UV}		180	210	240	mV
CTLx Over Voltage Threshold	V_{CTL_OV}		6	6.4	6.8	V
Thermal Shutdown Threshold	T_{ST}			150		$^{\circ}C$
FF Pull Down Resistance	R_{FF}			22		Ω
VFAULT Pull Down Current	I_{FAULT}		40	55	70	μA
VFAULT Blocking-Off Voltage (with Respect to V_{IN})	V_{FAULT}	$V_{IN} = 24V$, $V_{IN} - V_{FAULT}$	5	5.5	6	V

PIN FUNCTIONS

Pin #	Name	Description
1	VIN	Supply Input. The power to the chip, as well as the step-up converter switch. Drive VIN with 9V-to-32V power source. Must be locally bypassed.
2	VCC	Internal 10V Linear Regulator Output. Provides power for the internal MOSFET switch gate driver and the internal control circuitry. Bypass VCC to GND with a ceramic capacitor.
3	COMP	Step-up Converter Compensator. Compensates the regulation control loop. Connect a ceramic capacitor from COMP to GND.
4	OSC	Switching Frequency Set. Connect a resistor between OSC and GND to set the step-up converter's switching frequency. The voltage at this pin is regulated to 1.23V. The clock frequency is proportional to the current sourced from this pin.
5	EN	Enable Control Input. Do not leave this pin floating. Use a ceramic capacitor for local filtering.
6	DIM	Dimming. For PWM dimming, apply an external PWM signal with amplitude greater than 1.5V. For analog dimming, apply a DC voltage ranging from 0.4V to 1.5V to linearly set the LED current from 0% to 100%.
7	FB1	LED Current Feedback. Detects the channel 1 current.
8	CTL1	External Transistor Control Pin. Connect it to the base of an external transistor to regulate the channel 1 current.
9	FB2	LED Current Feedback. Detects the channel 2 current.
10	CTL2	External Transistor Control Pin. Connect it to the base of an external transistor to regulate the channel 2 current.
11	FB3	LED Current Feedback. Detects the channel 3 current.
12	CTL3	External Transistor Control Pin. Connect it to the base of an external transistor to regulate the channel 3 current.
13	FB4	LED Current Feedback. Detects the channel 4 current.
14	CTL4	External Transistor Control Pin. Connect it to the base of an external transistor to regulate the channel 4 current.
15	CTL5	External Transistor Control Pin. Connect it to the base of an external transistor to regulate the channel 5 current.
16	FB5	LED Current Feedback. Detects the channel 5 current.

PIN FUNCTIONS *(continued)*

Pin #	Name	Description
17	CTL6	External Transistor Control Pin. Connect it to the base of an external transistor to regulate the channel 6 current.
18	FB6	LED Current Feedback. Detects the channel 6 current.
19	CTL7	External Transistor Control Pin. Connect it to the base of an external transistor to regulate the channel 7 current.
20	FB7	LED Current Feedback. Detects the channel 7 current.
21	CTL8	External Transistor Control Pin. Connect it to the base of an external transistor to regulate the channel 8 current.
22	FB8	LED Current Feedback. Detects the channel 8 current.
23	FF	Fault Flag Output. Open drain of internal N-MOSFET. Pulled up to external DC level in normal mode. Internal MOSFET turns on and the FF is pulled to GND when open/short protection triggers.
24	OVP	Over-Voltage Protection Input. Connect a resistor divider from the output to this pin to program the OVP threshold. When this pin voltage reaches 1.23V, the MP3393 triggers OVP mode.
25	GND	Step-Up Converter Power Ground.
26	ISENSE	Current Sense. Senses the voltage across the external inductor-current sensing resistor for peak current mode control and to limit inductor current during each switching cycle. If this pin is not used for daisy-chaining with another MP3393, tie this pin to GND: do not leave it floating.
27	GATE	Step-up Converter Power Switch Gate Output. Drives the external power NMOS.
28	VFAULT	Fault Disconnection Switch Gate Output. Turns on the external PMOS during normal operation. When the MP3393 is disabled, the external PMOS turns off to disconnect the input and output.

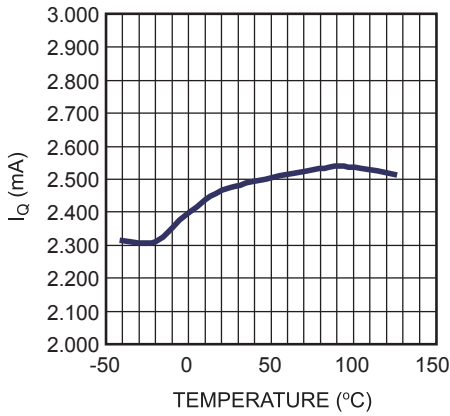
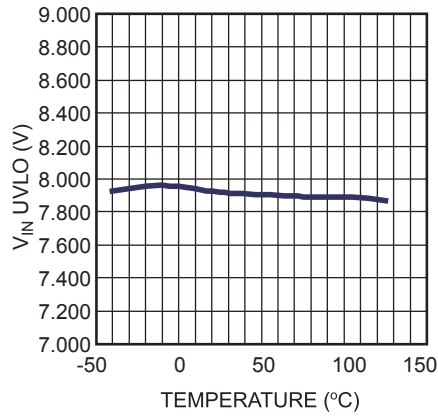
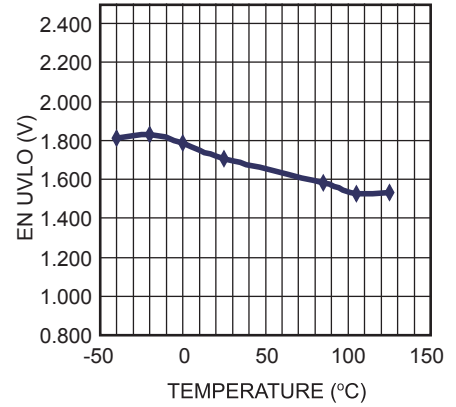
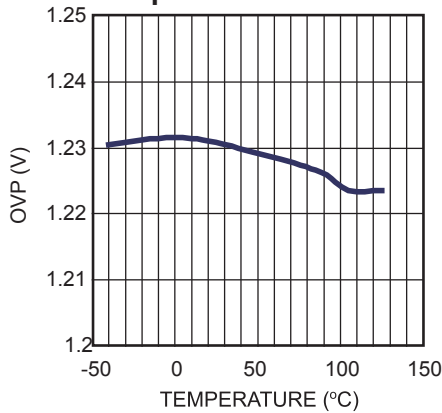
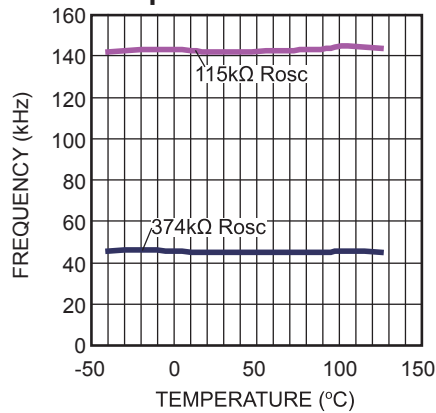
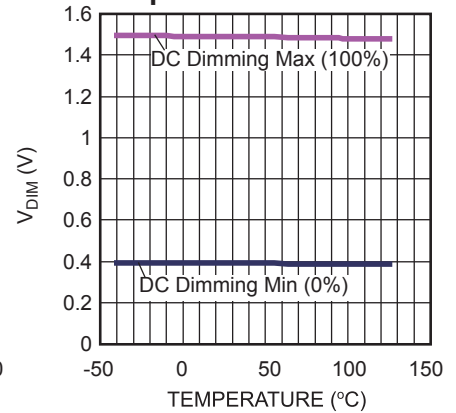
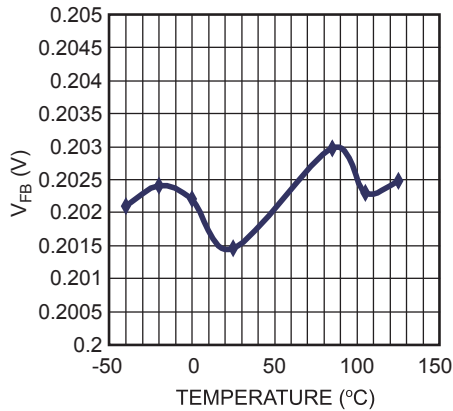
TYPICAL CHARACTERISTICS
 I_Q vs. Temperature

 V_{IN} UVLO vs. Temperature

EN UVLO vs. Temperature

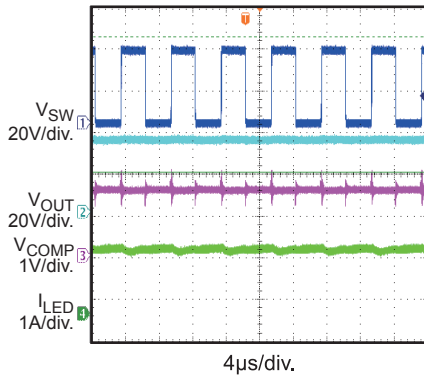
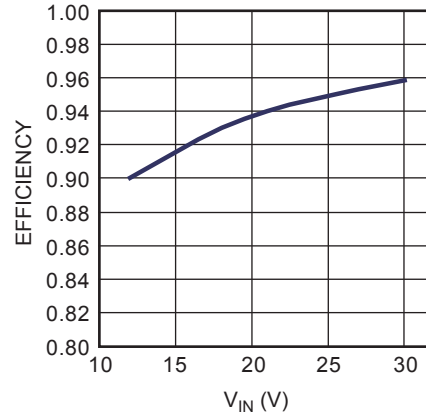
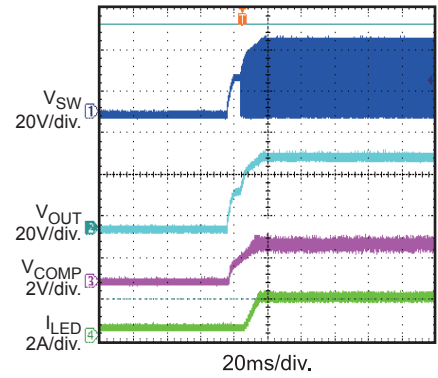
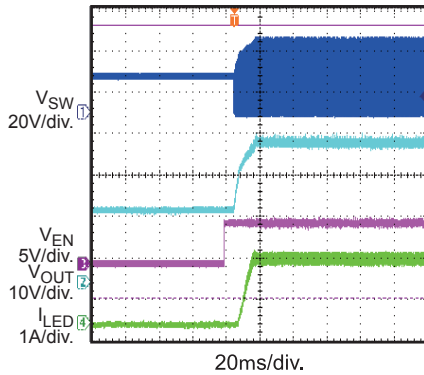
OVP Protection Point vs. Temperature

Operation Frequency vs. Temperature

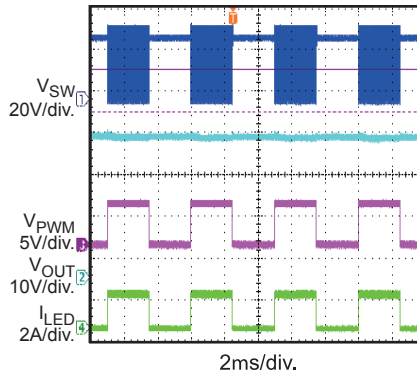
DC Dimming Range vs. Temperature

FB vs. Temperature

TYPICAL PERFORMANCE CHARACTERISTICS

$V_{IN} = 18V$, 10 LEDs in series, 8 strings parallel, 200mA/string, unless otherwise noted.

Steady State

Efficiency vs. Vin

Vin Power On

EN Power On

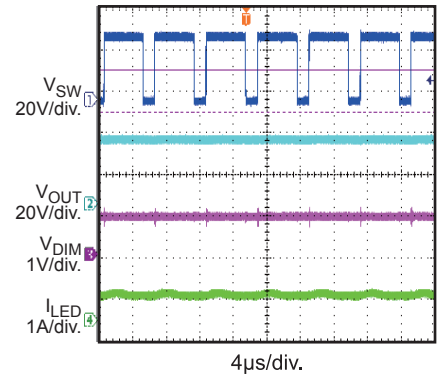
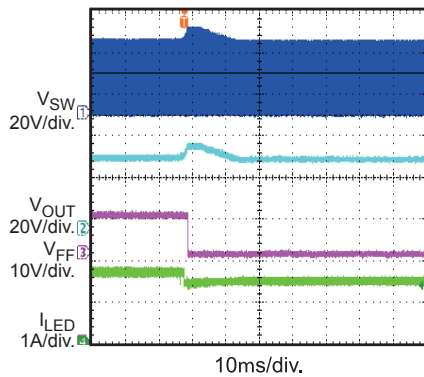
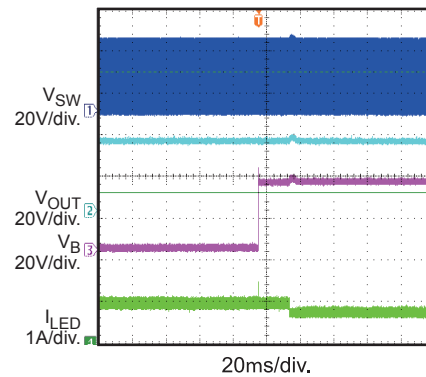
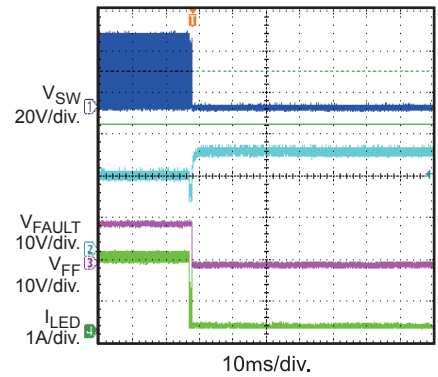
PWM Dimming

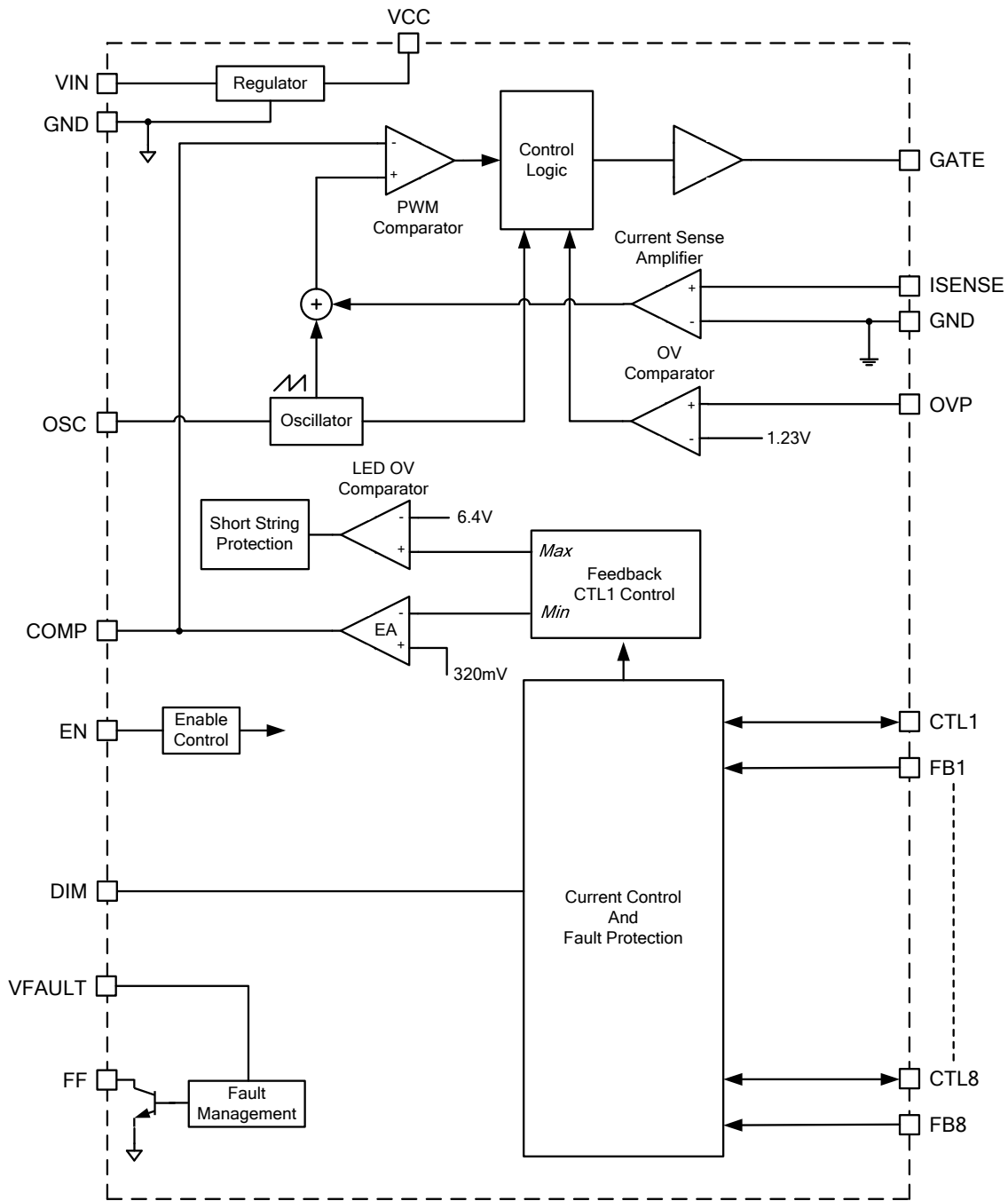
200Hz 50% PWM Dimming

DC Dimming

$V_{DIM} = 0.8V$

Open a string@ working normally

Short a string@ working normally

Short Vout to GND@ working normally

FUNCTIONAL BLOCK DIAGRAM

Figure 1: MP3393 Functional Block Diagram

OPERATION

The MP3393 is a step-up controller with 8 internal constant current control circuit to regulate an array of 8 strings of white LEDs. It employs peak-current mode with programmable operation frequency. Refer to the block diagram in Figure 1 for some of the operational details.

Internal 10V Regulator

The MP3393 has an internal linear regulator, VCC. When VIN exceeds 10V, this regulator provides a 10V power supply for the internal MOSFET switch gate driver and the internal control circuitry. The VCC voltage drops to 0V when the chip shuts down. The MP3393 features under-voltage lockout that disables the chip until VCC exceeds the UVLO threshold. The UVLO hysteresis is approximately 400mV.

System Startup

When the MP3393 is enabled, the chip monitors the OVP pin to see whether the Schottky diode is connected and whether the boost output is shorted to GND. The chip is disabled if the OVP voltage drops below 70mV. The MP3393 also checks for other safety limits, including under-voltage, over-voltage, and over-temperature conditions. If the device functions within normal working parameters, it boosts the output voltage with an internal soft-start.

The start-up sequence consists of establishing the input voltage and the PWM dimming signal before the enable signal.

Step-up Converter

The device's operating frequency is programmable from 100kHz to 500kHz through an external set resistor on the OSC pin. This customizable frequency is helpful to optimize external components for size and efficiency.

At the beginning of each cycle, the internal clock turns on the external MOSFET. The addition of a stabilizing ramp at the output of the current-sent amplifier prevents sub-harmonic oscillations at duty cycles greater than 50%; the output is fed into the PWM comparator. When this voltage reaches the output voltage level of the error amplifier (V_{COMP}), the external MOSFET turns off. The voltage at the output of the internal error amplifier is the amplified difference between the

320mV reference voltage and the feedback voltage. The converter automatically chooses the lowest active CTLx pin voltage to provide the bus voltage to power all the LED arrays.

If the feedback voltage drops below the 300mV reference, the output of the error amplifier increases. This results in more current flowing through the power FET, thus increasing the power delivered to the output. In this way it forms a closed loop to regulate the output voltage.

Internal Accurate Constant Current Control

The MP3393 employs an internal current-control circuit to provide accurate constant current regulation. The FBx pin detects the LED current and provides the signal to the current-control circuit. The CTLx pin controls the external PNP transistor to accurately regulate the LED current. Both features improve thermal performance for high-current LED applications.

Dimming Control

The MP3393 provides both analog dimming mode and external PWM dimming mode. For analog dimming mode, apply a 0.4V-to-1.5V DC signal on the PWM pin to linearly program the LED current from 0% to 100%. For PWM dimming, apply an external PWM signal: The brightness of the LED array is proportional to the duty cycle of the external PWM signal. Use a PWM frequency range from 50Hz to 2kHz.

Open-String Protection

The MP3393 uses over-voltage protection (OVP) to provide open string protection: If one or more strings are open, then the voltage on the respective CTLx pin is low and the IC keeps raising the output voltage until it reaches the OVP threshold. The part can then discern the open strings and shut down it because their CTLx pin voltages are less than 210mV. Once the part finishes determining the open strings, the remaining LED strings force the output voltage back into tight regulation. The string with the highest voltage drop is the feedback string that regulates the output voltage.

The MP3393 always tries to light at least one string: If all strings in use are open, the MP3393 shuts down the step-up converter. The open

strings maintain their off status until the chip restarts.

Short String Protection

The MP3393 monitors the CTLx pin voltage to determine the presence of a short string. If one or more strings are shorted, the respective CTLx pins pull up to the boost output and tolerate high voltage stress. If a CTLx pin voltage exceeds 6.5V, it meets the short string condition. When the short string fault (CTLx over-voltage fault) continues longer than 3072 clock cycles, the device marks off the shorted string and disables it. Once a string is marked-off, its current regulator disconnects from the output voltage loop regulation. The marked-off LED strings remain off until the chip restarts. If all strings in use are shorted, the MP3393 shuts down the step-up converter.

Short V_{OUT} to GND Protection

The MP3393 detects when V_{OUT} is shorted to GND when the OVP pin voltage is lower than 70mV, and triggers the SCP. The VFAULT pin rises to V_{IN} to turn off the external P-MOSFET, which connects the input power source to the step-up converter.

Fault-Flag Indicator

In normal mode, the FF rises to VCC through the pull-up resistor. Under short-circuit, open-circuit, or thermal shutdown conditions, the FF pin is pulled to GND and indicates the appropriate fault state.

APPLICATION INFORMATION

Selecting the Switching Frequency

The switching frequency of the step-up converter is programmable from 100kHz to 500kHz. A resistor on the OSC pin sets the internal oscillator frequency for the step-up converter according to the equation:

$$f_{SW} = 16000 / R_{OSC} \text{ (k}\Omega\text{)}$$

For $R_{OSC}=100\text{k}\Omega$, the switching frequency is 160kHz.

Setting the LED Current

The LED string currents are identical and set through the current sense resistor on the FB pin.

$$I_{LED} = 202\text{mV} / R_{SET}$$

For $R_{FB}=2\Omega$, the LED current is set to 101mA. The FB pin cannot be left open.

Selecting the Input Capacitor

The input capacitor reduces the surge current drawn from the input supply and the switching noise from the device. The input capacitor's impedance at the switching frequency should be less than the input source impedance to prevent high-frequency switching current from passing through the input. Use ceramic capacitors with X5R or X7R dielectrics for their low ESR and small temperature coefficients. For most applications, use a 4.7 μF ceramic capacitor in parallel with a 220 μF electrolytic capacitor.

Selecting the Inductor and Current Sensing Resistor

The device requires an inductor to force the output voltage higher while being driven by the input voltage. A larger-value inductor results in less ripple current, resulting in lower peak inductor current and reducing stress on the external N-Channel MOSFET of step-up converter. However, the larger-value inductor is physically larger, has a higher series resistance and lower saturation current.

Choose an inductor that does not saturate under the worst-case load conditions. The minimum value of inductor is selected to ensure that the boost converter works in continuous conduction mode for high efficiency and good EMI performance.

Calculate the required inductance value by the equation:

$$L \geq \frac{\eta \times V_{OUT} \times D \times (1-D)^2}{2 \times f_{SW} \times I_{LOAD}}$$

$$D = 1 - \frac{V_{IN}}{V_{OUT}}$$

Where V_{IN} and V_{OUT} is the input and output voltage, f_{SW} is the switching frequency, I_{LOAD} is the LED load current, and η is the efficiency.

The switch current is usually used for the peak current mode control. In order to avoid hitting the current limit, the voltage across the sensing resistor R_{SENSE} should be less than 80% of the worst case current limit voltage, V_{SENSE} .

$$R_{SENSE} = \frac{0.8 \times V_{SENSE}}{I_{L(PEAK)}}$$

$$I_{L(PEAK)} = \frac{V_{OUT} \times I_{LOAD}}{\eta V_{IN}} + \frac{V_{IN} \times (V_{OUT} - V_{IN})}{2 \times L \times f_{SW} \times V_{OUT}}$$

Where $I_{L(PEAK)}$ is the peak value of the inductor current. V_{SENSE} is shown in Figure 2.

Current Limit vs. Duty Cycle

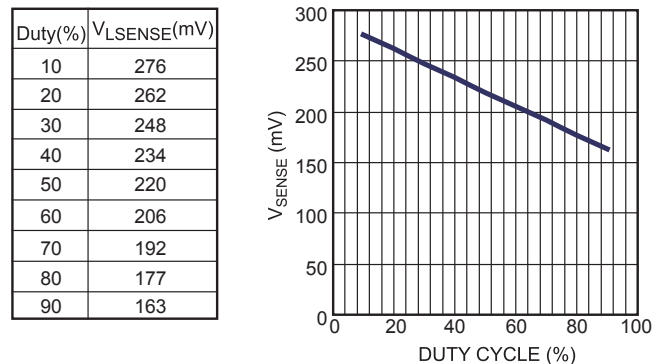

Figure 2: V_{SENSE} vs Duty Cycle

Selecting External Bipolar Junction Transistor

Each LEDs string has a bipolar junction transistor (BJT) in order to regulate LED current. Voltage rating and current rating of BJT should exceed $1.2 \times V_{OUT}$ and $1.5 \times I_{LED}$.

Static Forward Current Transfer Ratio (h_{FE}) must be given by: $h_{FE-MIN} > I_{LED} / I_{CTL-MIN}$

Where

- h_{FE-MIN} is minimum value of current transfer ratio on BJT manufacturer's datasheet.
- $I_{CTL-MIN}$ is minimum threshold of maximum sink current of CTRLx pin. It is 5.5mA on EC table.

Selecting the Power MOSFET

The MP3393 is capable of driving a wide variety of N-Channel power MOSFETS. The critical parameters of selection of a MOSFET are:

1. Maximum drain-to-source voltage, $V_{DS(MAX)}$
2. Maximum current, $I_{D(MAX)}$
3. On-resistance, $R_{DS(ON)}$
4. Gate source charge Q_{GS} and gate drain charge Q_{GD}
5. Total gate charge, Q_G

Ideally, the off-state voltage across the MOSFET equals the output voltage. Given the turn-off voltage spike, $V_{DS(MAX)}$ should exceed $1.5 \times V_{OUT}$.

The maximum current through the power MOSFET happens when the input voltage is at a minimum and the output power is at a maximum. The maximum RMS current through the MOSFET is given by

$$I_{RMS(MAX)} = I_{IN(MAX)} \times \sqrt{D_{MAX}}$$

Where:

$$D_{MAX} \approx \frac{V_{OUT} - V_{IN(MIN)}}{V_{OUT}}$$

The current rating of the MOSFET should be greater than $1.5 \times I_{RMS}$.

The ON resistance of the MOSFET determines the conduction loss, which is given by:

$$P_{cond} = I_{RMS}^2 \times R_{DS(on)} \times k$$

Where k is the temperature coefficient of the MOSFET

The switching loss is related to Q_{GD} and Q_{GS1} , which determine the commutation time: Q_{GS1} is the charge when the gate driver charges V_G from V_{TH} to V_{PLT} ; Q_{GD} is the charge during the period when V_G stays at the plateau voltage. Q_{GS1} can be read in the chart of V_{GS} vs. Q_G of the MOSFET datasheet. These two parameters are needed to

estimate the turn-on and turn-off losses to estimate the total switching loss, P_{SW} .

$$P_{SW} = \frac{Q_{GS1} \times R_G}{V_{DR} - V_{TH}} \times V_{DS} \times I_{IN} \times f_{SW} + \frac{Q_{GD} \times R_G}{V_{DR} - V_{PLT}} \times V_{DS} \times I_{IN} \times f_{SW}$$

Where

- V_{TH} is the threshold voltage,
- V_{PLT} is the plateau voltage,
- R_G is the gate resistance,
- V_{DS} is the drain-source voltage.

Please note that the switching loss is the most difficult part in the loss estimation. The equation above only provides a simple estimate expression.

The total gate charge, Q_G , is used to calculate the gate drive loss, where:

$$P_{DR} = Q_G \times V_{DR} \times f_{SW}$$

Where V_{DR} is the drive voltage

Selecting the Output Capacitor

The output capacitor limits the output voltage ripple and ensures feedback loop stability. Select a capacitor with low impedance at the switching frequency. For best results, use ceramic capacitors with X7R dielectrics for their low ESR characteristics. For most applications, use a 4.7µF ceramic capacitor in parallel with an electrolytic capacitor. Select the electrolytic capacitor using the following equation:

$$C_{OUT} = \frac{I_{OUT} * D}{f_{SW} * P_V}$$

Where

- C_{OUT} is the value of output electrolytic capacitor,
- I_{OUT} is total output current, and
- P_V is $\Delta V_{OUT}/V_{OUT}$.

Aim for a P_V in the range of 0.05% to 0.1%.

Setting the Over-Voltage Protection

The MP3393 uses OVP to achieve open-string protection. In some cases, an LED string open-failure results in low feedback voltage. The chip then keeps boosting the output voltage higher. If

the output voltage reaches the programmed OVP threshold, the protection will be triggered.

To make sure the chip function properly, the OVP setting resistor divider must be set with a proper value. The recommended OVP point is about 1.1 to $1.2 \times V_{OUT}$ for normal operation.

$$V_{OVP} = 1.23V \cdot (R_1 + R_2) / R_2$$

Extending LED Channels applications

The MP3393 can be daisy-chained to expand the number of LED channels using two or more MP3393s in parallel. To connect two MP3393s for a total of 16 LED strings, see Figure 5. Tie the VCC pins of the master and the slave IC together to provide power to the slave IC internal logic circuitry. Also tie the COMP pins of the master and the slave ICs together to regulate the voltage of all 16 strings LEDs. The MOSFET driving signals of the slave IC are not used, the boost converter can be only driven by the master IC. Do not leave the slave ISENSE pin floating; tie it to GND. The EN and DIM signals should be applied to both ICs. Use external PWM dimming mode to achieve accurate dimming synchronization of both parts.

Layout Considerations

Pay close attention to the PCB board layout and components placement. Proper layout of the high frequency switching path can prevent noise and electromagnetic interference problems. The high-frequency pulse current runs through the loop of the external MOSFET (M2), output diode (D1, D2), and output capacitor (C3, C4). This loop must be as small as possible (See Figure 3).

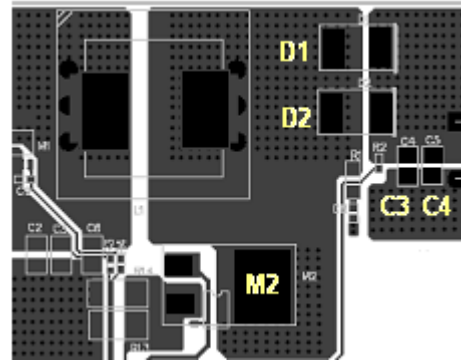

Figure 3: Layout Suggestion

The exposed IC pad internally connects to the GND pin, and all logic signals refer to GND. The PGND should connect externally to GND and should be kept away from the logic signals.

TYPICAL APPLICATION CIRCUIT

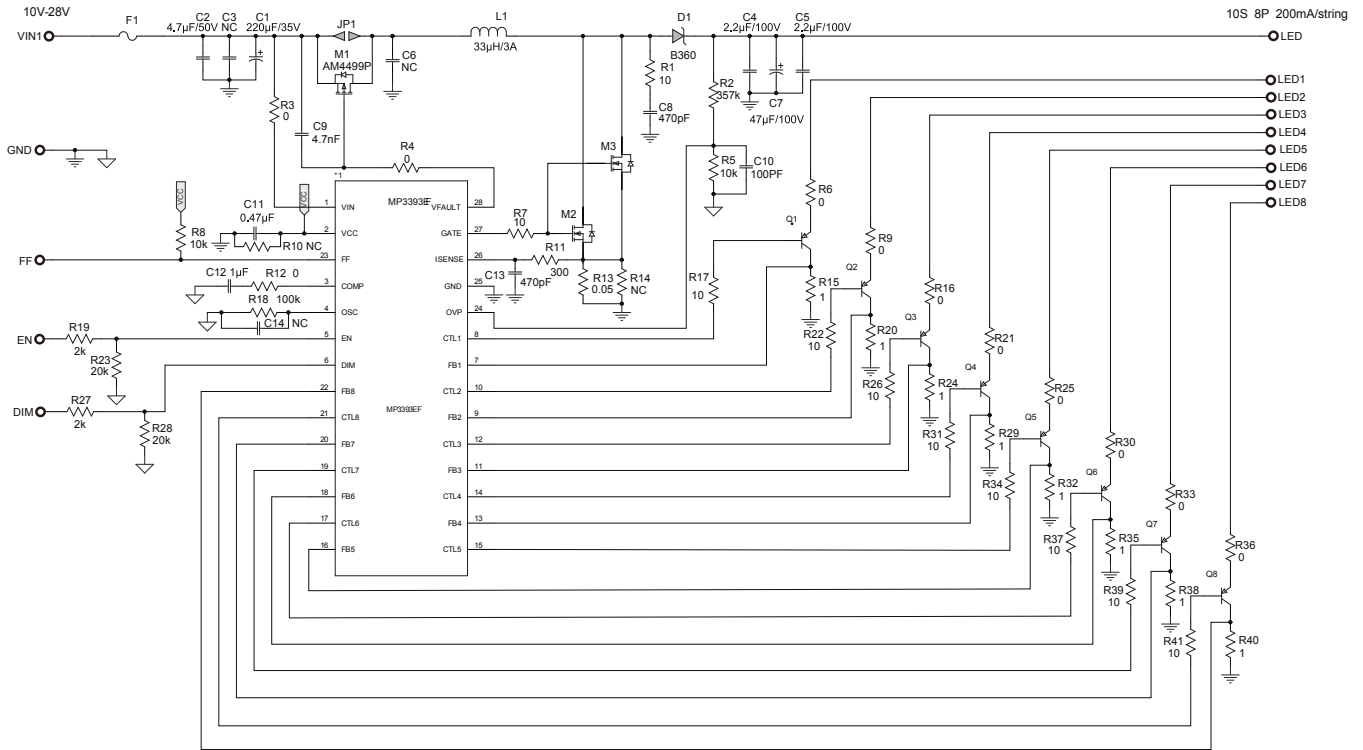

Figure 4: Driving 8 LED Strings

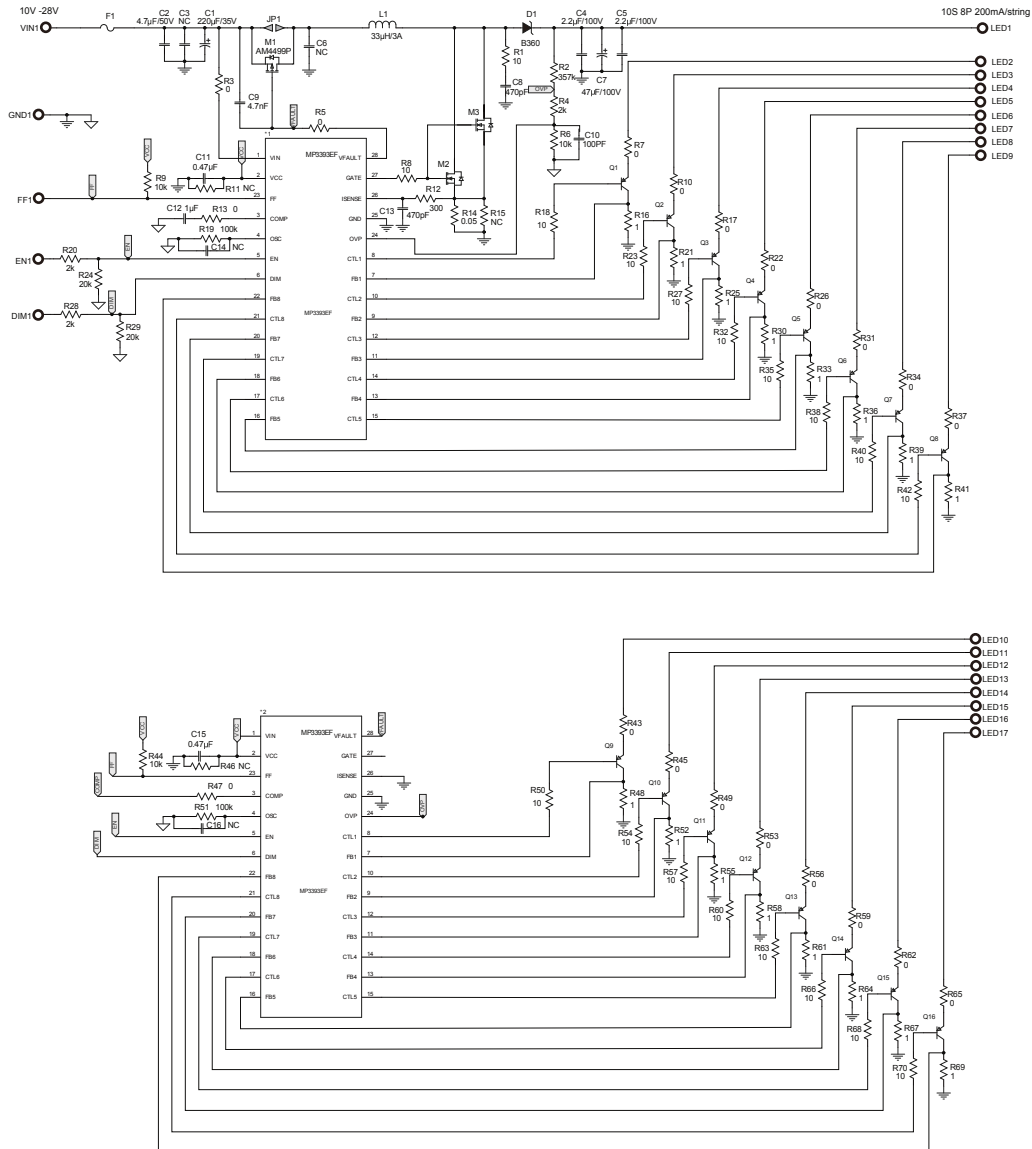
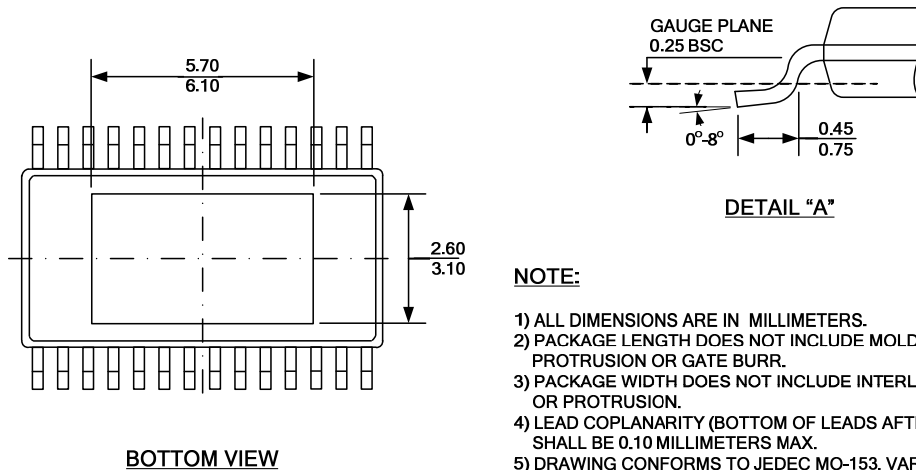
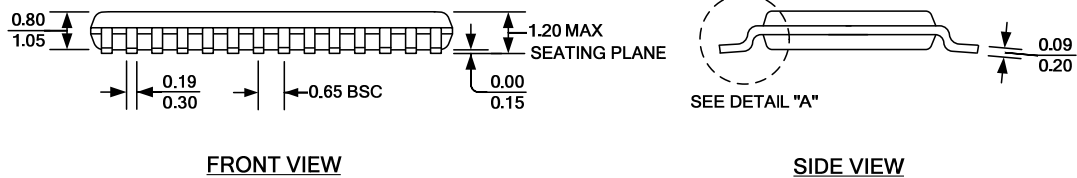
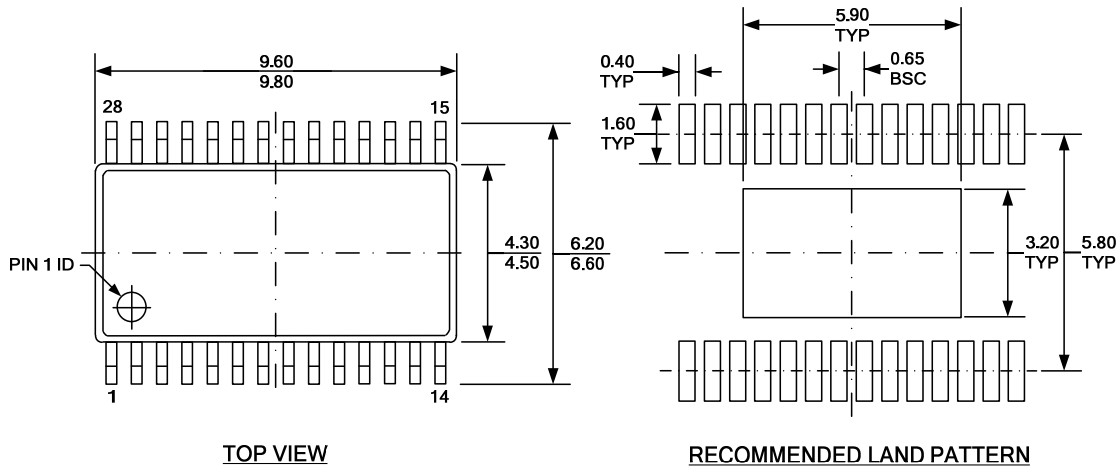
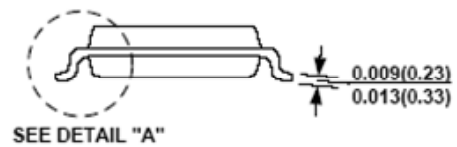
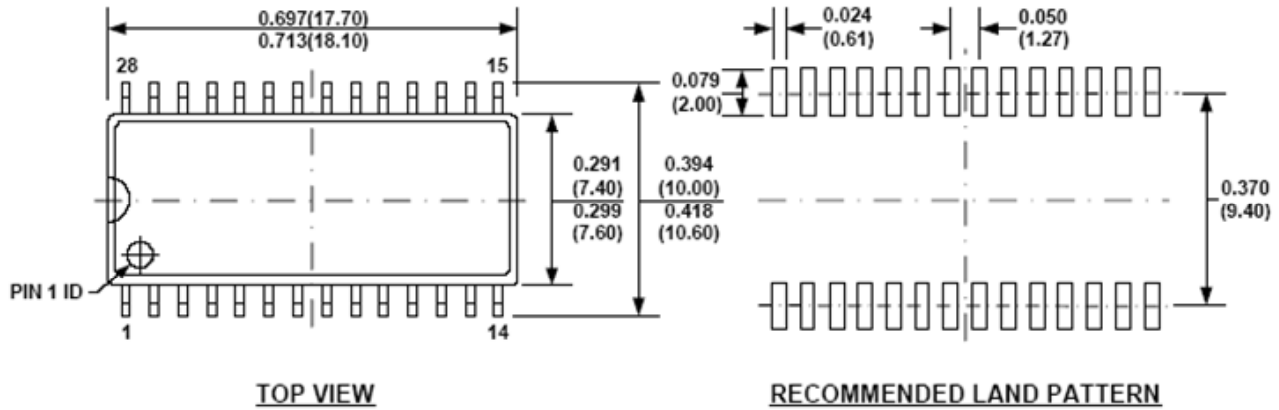
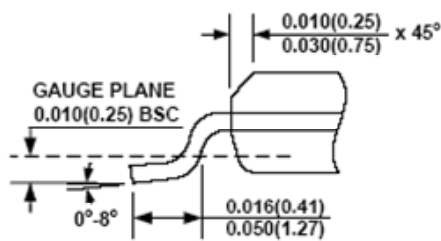

Figure 5: Driving 16 LED Strings (2 MP3393 in Parallel)

PACKAGE INFORMATION
TSSOP28EP

NOTE:

- 1) ALL DIMENSIONS ARE IN MILLIMETERS.
- 2) PACKAGE LENGTH DOES NOT INCLUDE MOLD FLASH, PROTRUSION OR GATE BURR.
- 3) PACKAGE WIDTH DOES NOT INCLUDE INTERLEAD FLASH OR PROTRUSION.
- 4) LEAD COPLANARITY (BOTTOM OF LEADS AFTER FORMING) SHALL BE 0.10 MILLIMETERS MAX.
- 5) DRAWING CONFORMS TO JEDEC MO-153, VARIATION AET.
- 6) DRAWING IS NOT TO SCALE.

PACKAGE INFORMATION
SOIC28

FRONT VIEW
SIDE VIEW

DETAIL "A"
NOTE:

- 1) CONTROL DIMENSION IS IN INCHES. DIMENSION IN BRACKET IS IN MILLIMETERS.
- 2) PACKAGE LENGTH DOES NOT INCLUDE MOLD FLASH, PROTRUSIONS OR GATE BURRS.
- 3) PACKAGE WIDTH DOES NOT INCLUDE INTERLEAD FLASH OR PROTRUSIONS.
- 4) LEAD COPLANARITY (BOTTOM OF LEADS AFTER FORMING) SHALL BE 0.10 MILLIMETERS MAX.
- 5) DRAWING CONFORMS TO JEDEC MS-013, VARIATION AE.
- 6) DRAWING IS NOT TO SCALE.

NOTICE: The information in this document is subject to change without notice. Users should warrant and guarantee that third party Intellectual Property rights are not infringed upon when integrating MPS products into any application. MPS will not assume any legal responsibility for any said applications.