

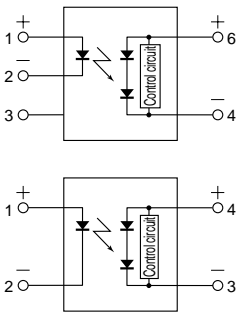

Panasonic
ideas for life

**PHOTOVOLTAIC
MOSFET DRIVER**

APV1,2



FEATURES

- 1. High-speed switching**
Since release time is 0.1 ms, the MOSFET can be turned off quickly in urgent situations.
- 2. Space saving**
With a built-in control circuit, an external resistor is not needed. This contributes to making substrates more compact.
- 3. High insulation**
DIP type: 5,000 V
SOP type: 2,500 V
SSOP type: 1,500 V
- 4. Extensive product lineup**
Products include the industry's smallest SSOP type, SOP4 type, and DIP 6 type.

TYPICAL APPLICATIONS

MOSFET driver
Power supply (Vcc) for electronic circuits

TYPES

Type	Output rating		Part No.				Packing quantity	
	Drop-out voltage (Typ.)	Short circuit current (Typ.)	Through hole terminal	Surface-mount terminal		Tube	Tape and reel	
			Tube packing style	Tube packing style	Tape and reel packing style			
				Picked from 1/2/3-pin side*1	Picked from 4/5/6-pin side*2			
DIP6pin	8.7V	14μA	APV1122	APV1122A	APV1122AX	APV1122AZ	1 tube contains 50 pcs. 1 batch contains 500 pcs.	1,000 pcs.
SOP4pin	8.7V	14μA	—	—	APV1121SX	APV1121SZ	1 tube contains 50 pcs. 1 batch contains 500 pcs.	
SOP4pin*3	8.2V	8μA	—	—	APV2121SX	APV2121SZ		
SSOP*4	8.2V	8μA	—	—	APV2111VY	APV2111VW	—	

Notes: *1 SOP type is picked from 1/2-pin side, SSOP type is picked from 1/4-pin side
 *2 SOP type is picked from 3/4-pin side, SSOP type is picked from 2/3-pin side
 *3 Tape package is the standard packing style. Also available in tube.
 (Part No. suffix "X" or "Y" is not needed when ordering; Tube: 100 pcs.; Case: 2,000 pcs.)
 For space reasons, the initial letters of the product number "AP" and "S" are omitted on the product seal.
 The package type indicator "X" and "Z" are omitted from the seal. (Ex. the label for product number APV1121SX is V1121).
 *4 Tape package is the standard packing style.
 For space reasons, the initial letters of the product number "AP" and "V" are omitted on the product seal.
 The package type indicator "Y" and "W" are omitted from the seal. (Ex. the label for product number APV2111VY is V2111).

RATING

1. Absolute maximum ratings (Ambient temperature: 25°C 77°F)

Item		Symbol	APV1122(A)	APV1121S	APV2121S	APV2111V	Remarks
Input	LED forward current	I _F	50mA				
	LED reverse voltage	V _R	5V				
	Peak forward current	I _{FP}	1A				f = 100 Hz, Duty Ratio = 0.1%
	Power dissipation	P _{in}	75mA				
I/O isolation voltage		V _{iso}	5,000V AC	2,500V AC	2,500V AC	1,500V AC	
Temperature limits	Operating	T _{opr}	-40°C to +85°C -40°F to +185°F				Non-condensing at low temperatures
	Storage	T _{stg}	-40°C to +100°C -40°F to +212°F				

MOSFET Driver
ASCT1B274E '03.7

New

APV1,2

2. Electrical characteristics (Ambient temperature: 25°C 77°F)

Item		Symbol	APV1122(A)	APV1121S	APV2121S	APV2111V	Condition
Input	LED operate current	Typical	0.6mA		0.85mA		$V_{oc} = 5V$
		Maximum	3mA				
	LED turn off current	Minimum	0.2mA				$V_{oc} = 1V$
		Typical	0.5mA		0.75mA		
LED dropout voltage	Typical	1.15V				$I_f = 10mA$	
	Maximum	1.5V					
Output	Drop-out voltage*	Minimum	6V		5V		$I_f = 10mA$
		Typical	8.7V		8.2V		
	Short circuit current**	Minimum	5 μ A		3 μ A		$I_f = 10mA$
		Typical	14 μ A		8 μ A		
Transfer characteristics	Turn on time***	Typical	0.4ms		0.8ms		$I_f = 10mA$, $C_L = 1,000pF$
	Turn off time***	Typical	0.1ms				$I_f = 10mA$, $C_L = 1,000pF$
	I/O capacitance	Typical	0.8pF				$V_B = 0V$, $f = 1MHz$
		Maximum	1.5pF				
Initial I/O isolation resistance	Minimum	1,000M Ω				500V DC	

Note: Recommended LED forward current I_{FT} : 10mA.

*Drop-out voltage measurement circuit

APV1122(A)

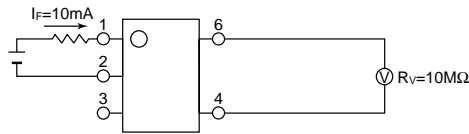

APV1121S, APV2121S, APV2111V

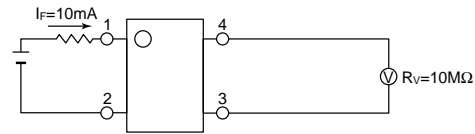

**Short circuit current measurement circuit

APV1122(A)

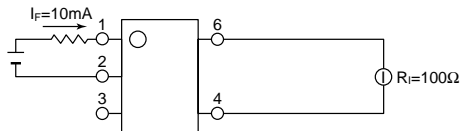

APV1121S, APV2121S, APV2111V

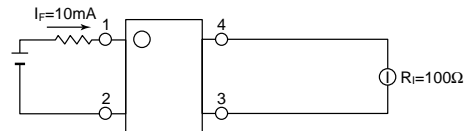

***Turn on/Turn off time measurement circuit

APV1122(A)

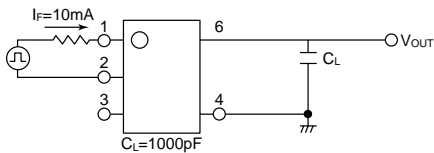

APV1121S, APV2121S, APV2111V

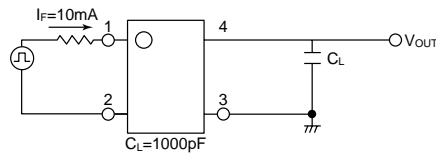

***Turn on time

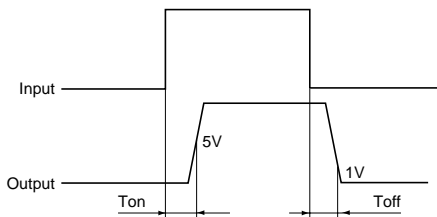

DIMENSIONS

1. APV2111V

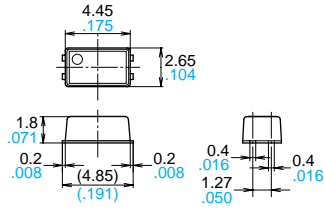

Terminal thickness: 0.15 .006
General tolerance: ±0.1 ±.004

Recommended mounting pad (TOP VIEW)

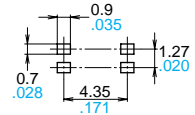

Tolerance: ±0.1 ±.004

2. APV1121S, APV2121S

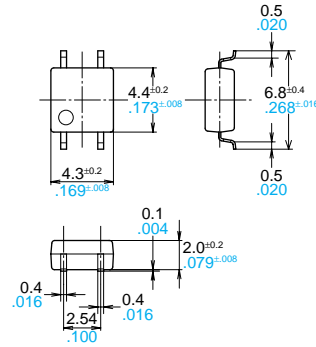

Terminal thickness: 0.15 .006
General tolerance: ±0.1 ±.004

Recommended mounting pad (TOP VIEW)

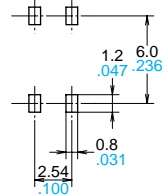

Tolerance: ±0.1 ±.004

3. (1) APV1122

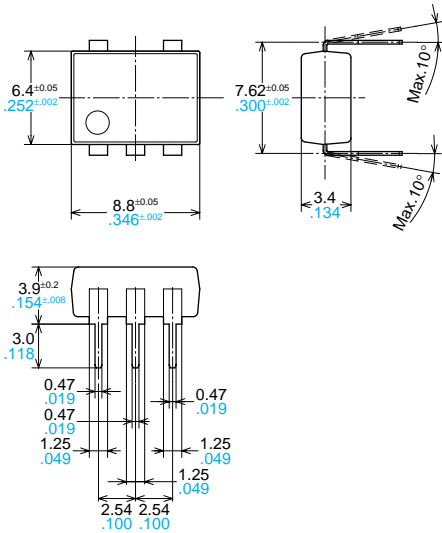

Terminal thickness: 0.25 .010
General tolerance: ±0.1 ±.004

PC board pattern (BOTTOM VIEW)

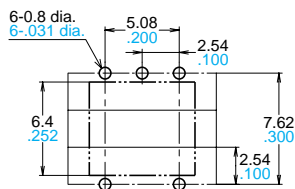

Tolerance: ±0.1 ±.004

3. (2) APV1122A

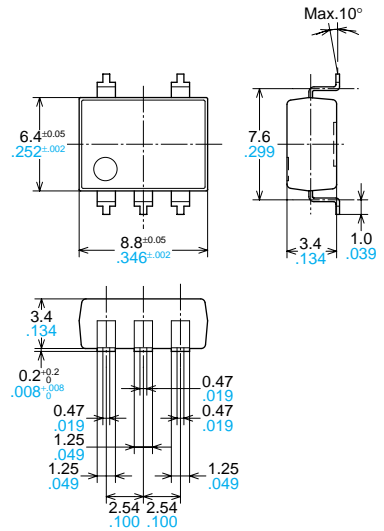

Terminal thickness: 0.25 .010
General tolerance: ±0.1 ±.004

Recommended mounting pad (TOP VIEW)

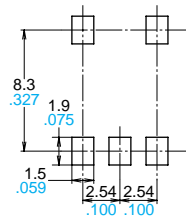

Tolerance: ±0.1 ±.004

APV1,2

REFERENCE DATA

1. Drop-out voltage vs. ambient temperature characteristics

Input current: 10mA

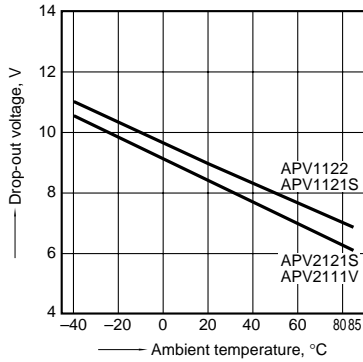

2. Short circuit current vs. ambient temperature characteristics

Input current: 10mA

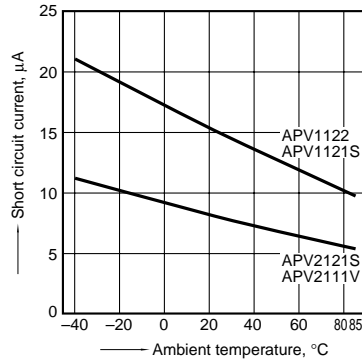

3. LED operate current vs. ambient temperature characteristics

Drop-out voltage: 5V

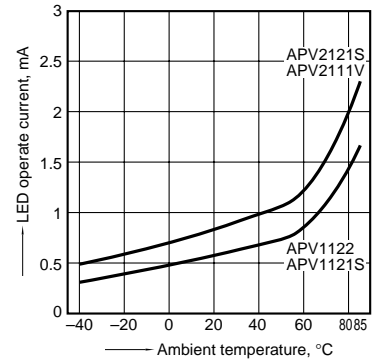

4. LED turn off current vs. ambient temperature characteristics

Drop-out voltage: 1V

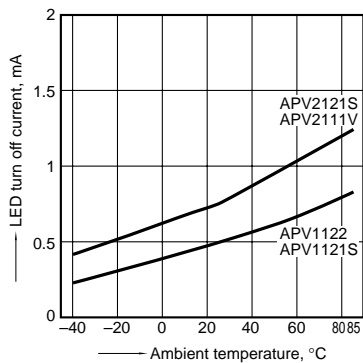

5. LED dropout voltage vs. ambient temperature characteristics

LED forward current: 5 to 50mA

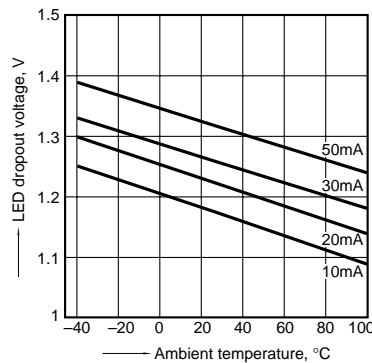

6. Turn on time vs. ambient temperature characteristics

LED forward current: 10mA

Load capacity: 1,000pF; output voltage: 5V

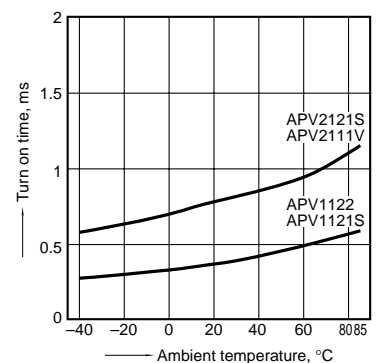

7. Turn off time vs. ambient temperature characteristics

LED forward current: 10mA

Load capacity: 1,000pF; output voltage: 1V

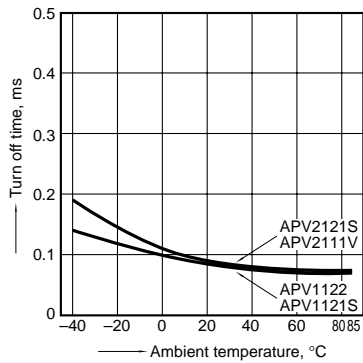

8. Turn on time vs. LED forward current characteristics

Load capacity: 1,000pF; output voltage: 5V

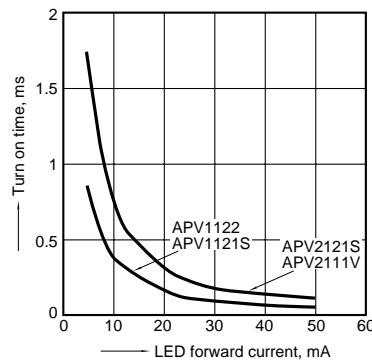

9. Turn off time vs. LED forward current characteristics

Load capacity: 1,000pF; output voltage: 1V

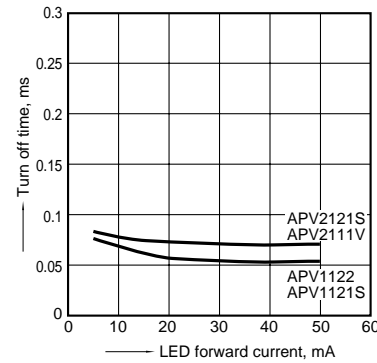

SCHEMATIC AND WIRING DIAGRAMS

Notes: E₁: Power source at input side; I_F: LED forward current;

1. APV1122 Schematic

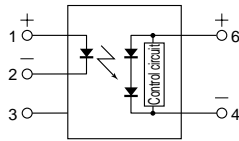

Power MOSFET drive wiring diagram

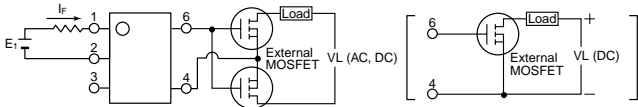

Example of each input power supply and current limit resistors (I_F = 10mA)

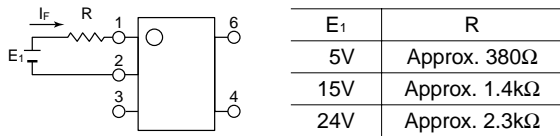

2. APV1121S, APV2121S, APV2111V Schematic

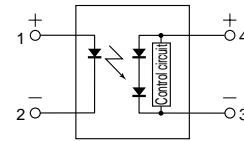

Power MOSFET drive wiring diagram

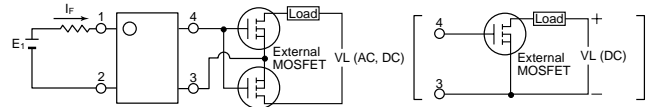

Example of each input power supply and current limit resistors (I_F = 10mA)

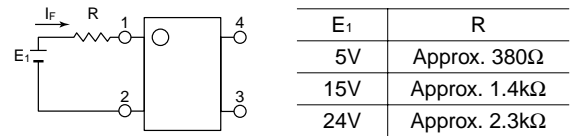

CAUTIONS FOR USE

1. When two external MOSFETs are connected with a common source terminal, oscillation may occur when operation is restored. Therefore, please insert a 100 to 1,000 ohms resistor between the gate terminal of the first MOSFET and the gate terminal of the second MOSFET.

A typical example of this is given in the circuit below.

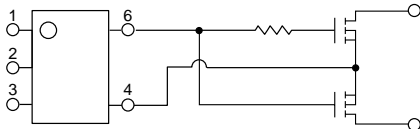

2. Deterioration and destruction caused by discharge of static electricity

This phenomenon is generally called static electricity destruction, and occurs when static electricity generated by various factors is discharged while the relay terminals are in contact, producing internal destruction of the element. To prevent problems from static electricity, the following precautions and measures should be taken when using your device.

1) Employees handling relays should wear anti-static clothing and should be grounded through protective resistance of 500 kΩ to 1 MΩ.

2) A conductive metal sheet should be placed over the work table. Measuring instruments and jigs should be grounded.

3) When using soldering irons, either use irons with low leakage current, or ground the tip of the soldering iron. (Use of low-voltage soldering irons is also recommended.)

4) Devices and equipment used in assembly should also be grounded.
5) When packing printed circuit boards and equipment, avoid using high-polymer materials such as foam styrene, plastic, and other materials which carry an electrostatic charge.

6) When storing or transporting relays, the environment should not be conducive to static electricity (for instance, the humidity should be between 45 and 60%), and relays should be protected using conductive packing materials.

3. Unused terminals

The No. 3 terminal is used with the circuit inside the relay. Therefore, do not connect it to the external circuitry. (DIP 6-pin type)

4. Short across terminals

Do not short circuit between terminals when relay is energized, since there is possibility of breaking of the internal IC.

5. Ripple in the input power supply

1) For LED operate current at E_{min}, maintain min. 10 mA

2) Keep the LED operate current at 50 mA or less at E_{max}.

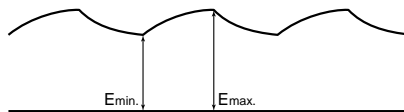

6. Soldering

1) When soldering PC board terminals, keep soldering time less than 10 s at 260°C 500°F.

2) When soldering surface-mount terminals, the following conditions are recommended.

(1) IR (Infrared reflow) soldering method

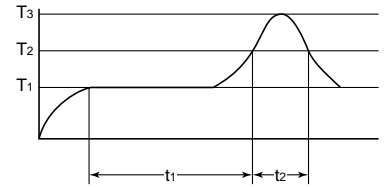

T₁ = 155 to 165°C 311 to 329°F
T₂ = 180°C 200°C 356 to 392°F
T₃ = 245°C 473°F or less
t₁ = 120 s or less
t₂ = 30 s or less

(2) Vapor phase soldering method

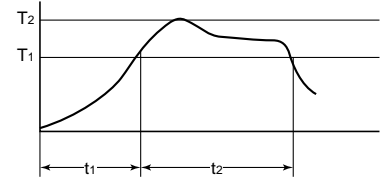

T₁ = 180 to 200°C 366 to 392°F
T₂ = 215°C 419°F or less
t₁ = 40 s
t₂ = 90 s or less (40 s: SOP type)

(3) Double wave soldering method

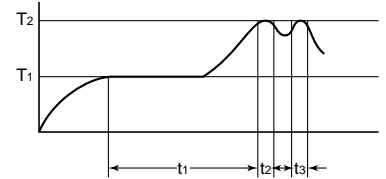

T₁ = 155 to 165°C 311 to 329°F
T₂ = 260°C 500°F or less
t₁ = 60 s or less
t₂+t₃ = 5 s or less

(4) Soldering iron method

Tip temperature: 280 to 300°C 536 to 572°F

Wattage: 30 to 60 W

Soldering time: within 5 s

APV1,2

(5) Others

Check mounting conditions before using other soldering methods (hot-air, hot plate, pulse heater, etc.)

7. Important Notes for Mounting

1) Temperature rise in the lead portion is highly dependent on package size. If multiple different packages are mounted on the same board, please check your board beforehand in an actual product, ensuring that the temperature conditions of the phototriac coupler fall within the parameters listed above.

8. Cleaning

The phototriac coupler forms an optical path by coupling a light-emitting diode (LED) and photodiode via transparent silicon resin. For this reason, unlike other directory element molded resin products (e.g., MOS transistors and bipolar transistors), avoid ultrasonic cleansing if at all possible. We recommend cleaning with an organic solvent. If you cannot avoid using ultrasonic cleansing, please ensure that the following conditions are met, and check beforehand for defects.

- Frequency: 27 to 29 kHz
- Ultrasonic output: No greater than 0.25 W/cm²
- Cleaning time: No longer than 30 s
- Cleanser used: Asahiklin AK-225
- Other: Submerge in solvent in order to prevent the PCB and elements from being contacted directly by the ultrasonic vibrations.

Note: Applies to unit area ultrasonic output for ultrasonic baths.

9. Storage

SSOP package (APV2111V) and SO package (APV1121S, APV2121S) are sensitive to moisture and come in sealed moisture-proof packages. Observe the following cautions on storage.

- After the moisture-proof package is unsealed, take the devices out of storage as soon as possible (within 1 month at the most).
- If the devices are to be left in storage for a considerable period after the moisture-proof package has been unsealed, it is recommended to keep them in another

moisture-proof bag containing silica gel (within 3 months at the most).

Note: When thermal stress is applied when solder mounting under moist conditions, water will evaporate, dilation will occur, the stress inside of the package will increase, and swelling and cracking might occur on the package surface. Therefore, please be careful while following the soldering conditions given on the next page.

10. Transportation and storage

1) Extreme vibration during transport will warp the lead or damage the relay. Handle the outer and inner boxes with care.

2) Storage under extreme conditions will cause soldering degradation, external appearance defects, and deterioration of the characteristics. The following storage conditions are recommended:

- Temperature: 0 to 45°C **32 to 113°F**
- Humidity: Less than 70% R.H.
- Atmosphere: No harmful gasses such as sulfurous acid gas, minimal dust.

11. The following shows the packaging format

1) Tape and reel

mm inch

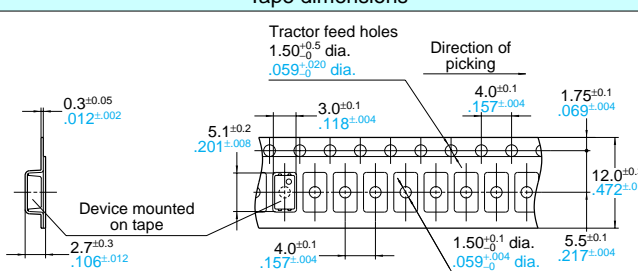
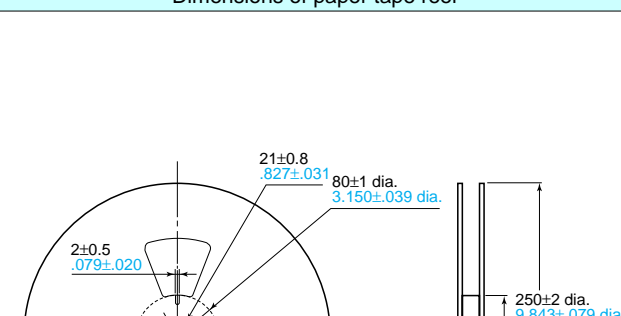
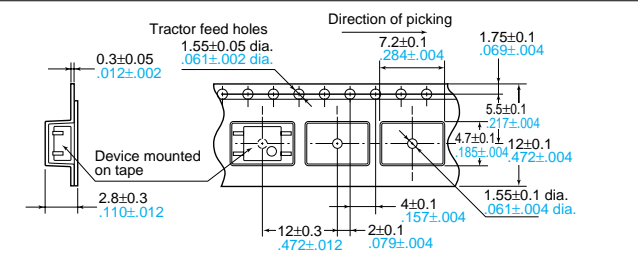
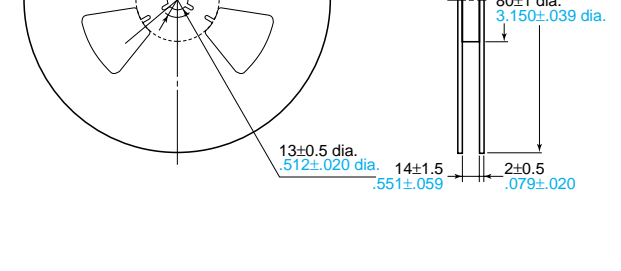
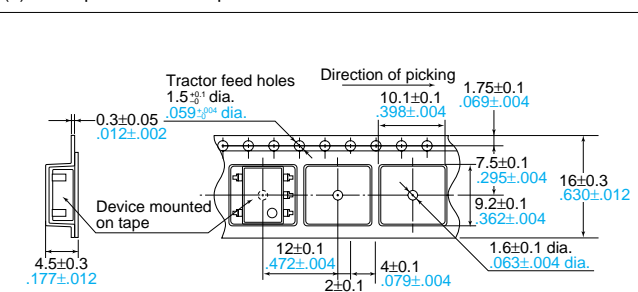
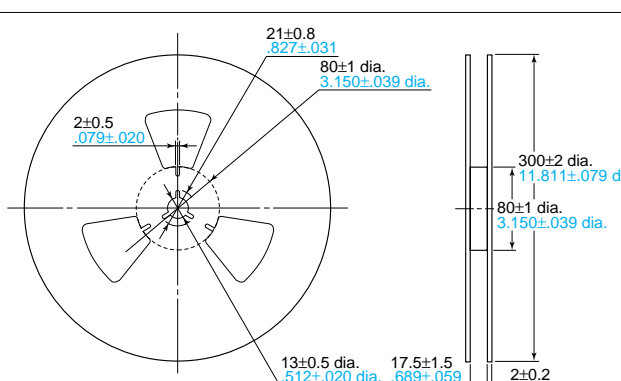
Type	Tape dimensions	Dimensions of paper tape reel
SSOP 4-pin type	 <p>Tractor feed holes 1.50^{+0.5} dia. .059^{+0.020} dia.</p> <p>Direction of picking</p> <p>0.3^{+0.05} .012^{+0.002}</p> <p>5.1^{+0.2} .201^{+0.008}</p> <p>3.0^{+0.1} .118^{+0.004}</p> <p>4.0^{+0.1} .157^{+0.004}</p> <p>1.75^{+0.1} .069^{+0.004}</p> <p>12.0^{+0.3} .472^{+0.012}</p> <p>2.7^{+0.3} .106^{+0.012}</p> <p>4.0^{+0.1} .157^{+0.004}</p> <p>1.50^{+0.1} dia. .059^{+0.020} dia.</p> <p>5.5^{+0.1} .217^{+0.004}</p> <p>(1) When picked from 1/4-pin side: Part No. APV○○○VY (Shown above) (2) When picked from 2/3-pin side: Part No. APV○○○VW</p>	 <p>21±0.8 .827±.031</p> <p>80±1 dia. 3.150±.039 dia.</p> <p>2±0.5 .079±.020</p> <p>250±2 dia. 9.843±.079 dia.</p> <p>80±1 dia. 3.150±.039 dia.</p> <p>13±0.5 dia. .512±.020 dia.</p> <p>14±1.5 .551±.059</p> <p>2±0.5 .079±.020</p>
SO package 4-pin type	 <p>Tractor feed holes 1.55±0.05 dia. .061±.002 dia.</p> <p>Direction of picking</p> <p>0.3±0.05 .012±.002</p> <p>7.2±0.1 .284±.004</p> <p>1.75±0.1 .069±.004</p> <p>5.5±0.1 .217±.004</p> <p>4.7±0.1 .185±.004</p> <p>12±0.1 .472±.012</p> <p>2.8±0.3 .110±.012</p> <p>4±0.1 .157±.004</p> <p>1.55±0.1 dia. .061±.004 dia.</p> <p>12±0.3 .472±.012</p> <p>2±0.1 .079±.004</p> <p>(1) When picked from 1/2-pin side: Part No. APV○○○SX (Shown above) (2) When picked from 3/4-pin side: Part No. APV○○○SZ</p>	 <p>21±0.8 .827±.031</p> <p>80±1 dia. 3.150±.039 dia.</p> <p>2±0.5 .079±.020</p> <p>13±0.5 dia. .512±.020 dia.</p> <p>14±1.5 .551±.059</p> <p>2±0.5 .079±.020</p>
DIP 6-pin type	 <p>Tractor feed holes 1.5^{+0.1} dia. .059^{+0.020} dia.</p> <p>Direction of picking</p> <p>0.3±0.05 .012±.002</p> <p>10.1±0.1 .398±.004</p> <p>1.75±0.1 .069±.004</p> <p>7.5±0.1 .295±.004</p> <p>9.2±0.1 .362±.004</p> <p>16±0.3 .630±.012</p> <p>4.5±0.3 .177±.012</p> <p>12±0.1 .472±.004</p> <p>4±0.1 .157±.004</p> <p>1.6±0.1 dia. .063±.004 dia.</p> <p>2±0.1 .079±.004</p> <p>(1) When picked from 1/2/3-pin side: Part No. APV○○○AX (Shown above) (2) When picked from 4/6-pin side: Part No. APV○○○Z</p>	 <p>21±0.8 .827±.031</p> <p>80±1 dia. 3.150±.039 dia.</p> <p>2±0.5 .079±.020</p> <p>13±0.5 dia. .512±.020 dia.</p> <p>17.5±1.5 .689±.059</p> <p>2±0.2 .079±.008</p> <p>300±2 dia. 11.811±.079 dia.</p> <p>80±1 dia. 3.150±.039 dia.</p>

2) Tube

(1) MOSFET driver is packaged in a tube so pin No. 1 is on the stopper B side. Observe correct orientation when mounting them on PC boards.
(SOP type)

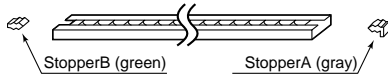

(DIP type)



12. Applying stress that exceeds the absolute maximum rating

If the voltage or current value for any of the terminals exceeds the absolute maximum rating, internal elements will deteriorate. In extreme cases, wiring may melt, or silicon P/N junctions may be destroyed.

As a result, the design should ensure that the absolute maximum ratings will never be exceeded, even momentarily.

Internet Homepage

- | | |
|--|---|
| ◆ North America : http://www.aromat.com/ | ◆ Asia & others : http://www.nais-e.com/ |
| ◆ Europe : http://www.mew-europe.com/ | • (Japanese) : http://www.mac-j.co.jp/ |
| | • (Chinese) : http://www.cmew.com.cn/ |

These materials are printed on ECF pulp.
These materials are printed with earth-friendly vegetable-based (soybean oil) ink.



Please contact

Matsushita Electric Works, Ltd.

Automation Controls Company

- Head Office: 1048, Kadoma, Kadoma-shi, Osaka 571-8686, Japan
 - Telephone: Japan (81) Osaka (06) 6908-1050
 - Facsimile: Japan (81) Osaka (06) 6908-5781
- <http://www.nais-e.com/>

COPYRIGHT © 2003 All Rights Reserved