

Sensor/actuator box - SACB-8/16- 5,0PUR OD - 1457364

Please be informed that the data shown in this PDF Document is generated from our Online Catalog. Please find the complete data in the user's documentation. Our General Terms of Use for Downloads are valid (<http://phoenixcontact.com/download>)



Sensor/actuator box, application: External areas, connection method: M12 socket Metal, number of slots: 8, number of positions: 5, coding: A - standard, slot assignment: Double, status display: No, Universal; master cable connection: Fixed connection 180°, PUR/PVC, cable length: 5 m, shielding: no

Your advantages

- Safety in the field, thanks to molded housing and high degree of protection
- Flexible, distributed bundling of signals in one master cable
- Save space: distributor box with double occupancy for two sensors in one slot

Key Commercial Data

Packing unit	1 pc
GTIN	
GTIN	4046356620833

Technical data

General

Rated voltage	120 V
Max. operating voltage U_{max}	135 V
Current carrying capacity per I/O signal	2 A
Current carrying capacity per slot	4 A
Total rated current	12 A
Number of positions	5
Number of slots	8
Sensor/actuator connection system	M12 socket

Ambient conditions

Degree of protection	IP65
	IP67
	IP69K
Ambient temperature (operation)	-30 °C ... 90 °C

Sensor/actuator box - SACB-8/16- 5,0PUR OD - 1457364

Technical data

Ambient conditions

	-40 °C ... 90 °C (cable, fixed installation)
	-5 °C ... 80 °C (cable, flexible installation)

Master cable connection data

Connection method	Fixed connection
Length of cable	5 m
Tightening torque slot sensor/actuator cable	0.4 Nm

Insulation material

Housing material	PBT
Material of the moulding mass	PUR
Contact material	Cu alloy
Contact surface material	gold-plated
Contact carrier material	PA
Material of threaded sleeve	Zinc die-cast
Material of threaded sleeve surface	tin-plated
O-ring material	FPM

Pin assignment

Slot/position = Wire color or connection	1 / 4 (A) = WH
	1 / 2 (B) = GY/PK
	2 / 4 (A) = GN
	2 / 2 (B) = RD/BU
	3 / 4 (A) = YE
	3 / 2 (B) = WH/GN
	4 / 4 (A) = GY
	4 / 2 (B) = BN/GN
	5 / 4 (A) = PK
	5 / 2 (B) = WH/YE
	6 / 4 (A) = RD
	6 / 2 (B) = YE/BN
	7 / 4 (A) = BK
	7 / 2 (B) = WH/GY
	8 / 4 (A) = VT
	8 / 2 (B) = GY/BN
	1-8 / 1 (+ 120 V) = BN
	1-8 / 3 (0 V) = BU
	1-8 / 5 (PE) = GN/YE

Standards and Regulations

Standard designation	M12 connector
Standards/regulations	IEC 61076-2-101

Sensor/actuator box - SACB-8/16- 5,0PUR OD - 1457364

Technical data

Cable

Cable type	PUR/PVC black
Cable type (abbreviation)	PUR
Cable abbreviation	LiYY11Y-HF
UL AWM style	20549 (80°C/300 V)
Conductor cross section	16x 0.5 mm ² (Signal line)
	3x 1 mm ² (power line)
AWG signal line	20
AWG power supply	17
Conductor structure signal line	28x 0.15 mm
Conductor structure, voltage supply	56x 0.15 mm
Core diameter including insulation	1.5 mm ±0.1 mm (Signal line)
	2.1 mm ±0.1 mm (power line)
Wire colors	brown, blue, green/yellow, white, green, yellow, gray, pink, red, black, violet, gray/pink, red/blue, white/green, brown/green, white/yellow, yellow/brown, white/gray, gray/brown
Overall twist	Wires twisted in layers
External sheath, color	black RAL 9005
Inner sheath thickness	≥ 0.15 mm
Outer sheath thickness	≥ 0.76 mm
External cable diameter D	10.5 mm ±0.2 mm
Minimum bending radius, fixed installation	7.5 x D
Minimum bending radius, flexible installation	10 x D
Number of bending cycles	1500000
Minimum bending radius, drag chain applications	10 x D
Traversing path	2 m
Traversing rate	2 m/s
Cable weight	183.7 kg/km
Outer sheath, material	PUR
Material, inner sheath	PVC
Material conductor insulation	PVC
Conductor material	Bare Cu litz wires
Nominal voltage, cable	300 V
Test voltage, cable	2000 V
Special properties	Silicone-free
Flame resistance	according to DIN EN 50265
Resistance to oil	according to VDE 0472 Part 803
Other resistance	Highly resistant to acids, alkaline solutions and solvents
Ambient temperature (operation)	-40 °C ... 90 °C (cable, fixed installation)
	-5 °C ... 80 °C (cable, flexible installation)

Environmental Product Compliance

China RoHS	Environmentally Friendly Use Period = 50
------------	--

Sensor/actuator box - SACB-8/16- 5,0PUR OD - 1457364

Technical data

Environmental Product Compliance

	For details about hazardous substances go to tab "Downloads", Category "Manufacturer's declaration"
--	---

Drawings

Schematic diagram

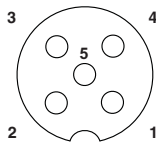

M12 slot, socket, 5-pos.

Cable cross section

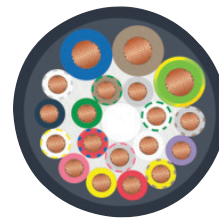

PUR/PVC black [PUR]

Dimensional drawing

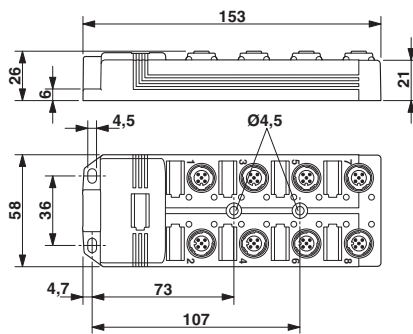

Circuit diagram

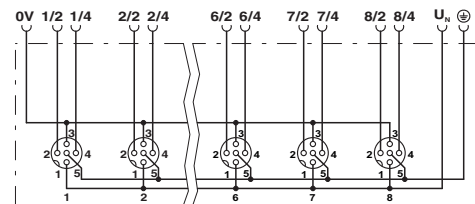

Approvals

Approvals

Approvals

DNV GL / EAC

Ex Approvals

Approval details

DNV GL	http://exchange.dnv.com/tari/	TAE00002K4
--------	---	------------

Sensor/actuator box - SACB-8/16- 5,0PUR OD - 1457364

Approvals

EAC



EAC-Zulassung

Phoenix Contact 2018 © - all rights reserved
<http://www.phoenixcontact.com>

PHOENIX CONTACT GmbH & Co. KG
Flachsmarktstr. 8
32825 Blomberg
Germany
Tel. +49 5235 300
Fax +49 5235 3 41200
<http://www.phoenixcontact.com>