

Sensor/actuator box - SACB-4/ 8-L-10,0HPUR SCO - 1517275

Please be informed that the data shown in this PDF Document is generated from our Online Catalog. Please find the complete data in the user's documentation. Our General Terms of Use for Downloads are valid (<http://phoenixcontact.com/download>)



Sensor/actuator box, application: Standard, connection method: M12-SPEEDCON-socket Metal, number of slots: 4, number of positions: 5, coding: A - standard, slot assignment: Double, status display: yes, pnp; master cable connection: Fixed connection 180°, PUR halogen free, cable length: 10 m, shielding: no

Your advantages

- Safety in the field, thanks to molded housing and high degree of protection
- Flexible, distributed bundling of signals in one master cable
- Convenient: increased machine availability thanks to quick and easy diagnostics
- Save space: distributor box with double occupancy for two sensors in one slot
- Save time, thanks to installation with SPEEDCON fast locking system



Key Commercial Data

Packing unit	1 pc
GTIN	 4 017918 967949
GTIN	4017918967949

Technical data

General

Rated voltage	24 V DC
Max. operating voltage U_{max}	30 V DC
Current carrying capacity per I/O signal	2 A
Current carrying capacity per slot	4 A
Total rated current	12 A
Number of positions	5
Number of slots	4
Flammability rating according to UL 94	V0
Sensor/actuator connection system	M12-SPEEDCON-socket

Ambient conditions

Degree of protection	IP65
----------------------	------

Sensor/actuator box - SACB-4/ 8-L-10,0HPUR SCO - 1517275

Technical data

Ambient conditions

	IP67
	IP69K
Ambient temperature (operation)	-30 °C ... 90 °C
	-40 °C ... 90 °C (for fixed installation)
	-5 °C ... 80 °C (for flexible installation)

Local diagnostics function

Local diagnostics	Supply voltage Green LED
	Status display I/O Yellow LED

Master cable connection data

Connection method	Fixed connection
Length of cable	10 m
Tightening torque slot sensor/actuator cable	0.4 Nm
Tightening torque of mounting screw for fixing the housing	0.5 Nm

Insulation material

Housing material	PBT
Material of the moulding mass	PUR
Contact material	Cu alloy
Contact surface material	gold-plated
Contact carrier material	PA
Material of threaded sleeve	Zinc die-cast
Material of threaded sleeve surface	Nickel-plated
O-ring material	NBR

Pin assignment

Slot/position = Wire color or connection	1 / 4 (A) = WH
	1 / 2 (B) = GY/PK
	2 / 4 (A) = GN
	2 / 2 (B) = RD/BU
	3 / 4 (A) = YE
	3 / 2 (B) = WH/GN
	4 / 4 (A) = GY
	4 / 2 (B) = BN/GN
	1-4 / 1 (+ 24 V) = BN
	1-4 / 3 (0 V) = BU
	1-4 / 5 (PE) = GN/YE

Standards and Regulations

Standard designation	M12 connector
Standards/regulations	IEC 61076-2-101
Connection in acc. with standard	CUL

Sensor/actuator box - SACB-4/ 8-L-10,0HPUR SCO - 1517275

Technical data

Standards and Regulations

Flammability rating according to UL 94	V0
--	----

Cable

Cable type	PUR halogen-free black
Cable type (abbreviation)	PUR
Cable abbreviation	Li9Y11Y-HF
Conductor cross section	3x 1 mm ² (power line) 8x 0.5 mm ² (Signal line)
AWG signal line	20
AWG power supply	17
Conductor structure signal line	64x 0.10 mm
Conductor structure, voltage supply	128x 0.10 mm
Wire colors	brown, blue, green/yellow, white, green, yellow, gray, gray/pink, red/ blue, white/green, brown/green
Overall twist	Wires twisted in layers
External sheath, color	black RAL 9005
External cable diameter D	9.4 mm ±0.2 mm
Smallest bending radius, fixed installation	94 mm
Smallest bending radius, movable installation	94 mm
Number of bending cycles	1500000
Bending radius	94 mm
Traversing path	2 m
Traversing rate	2 m/s
Outer sheath, material	PUR
Material conductor insulation	PP
Conductor material	Bare Cu litz wires
Nominal voltage, cable	300 V
Test voltage, cable	2000 V
Special properties	Silicone-free
Flame resistance	DIN EN 50265
Resistance to oil	according to VDE 0472 Part 803
Other resistance	Highly resistant to acids, alkaline solutions and solvents
Ambient temperature (operation)	-40 °C ... 90 °C (cable, fixed installation) -5 °C ... 80 °C (cable, flexible installation)

Environmental Product Compliance

China RoHS	Environmentally Friendly Use Period = 50
	For details about hazardous substances go to tab "Downloads", Category "Manufacturer's declaration"

Drawings

Sensor/actuator box - SACB-4/ 8-L-10,0HPUR SCO - 1517275

Schematic diagram

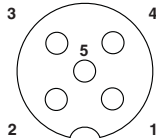

M12 slot, socket, 5-pos.

Cable cross section

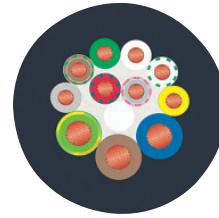

PUR halogen-free black [PUR]

Dimensional drawing

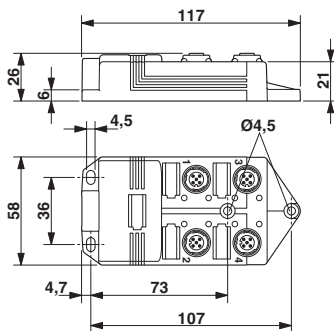

Circuit diagram

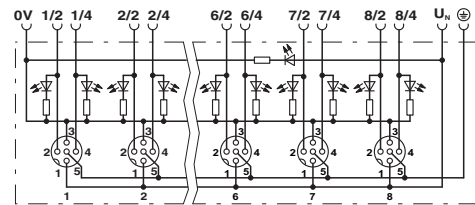

Approvals

Approvals

Approvals

UL Recognized / cUL Recognized / EAC / cULus Recognized

Ex Approvals

Approval details

UL Recognized		http://database.ul.com/cgi-bin/XYV/template/LISEXT/1FRAME/index.htm	FILE E 118976
Nominal voltage UN	24 V		
Nominal current IN	3 A		

Sensor/actuator box - SACB-4/ 8-L-10,0HPUR SCO - 1517275

Approvals

cUL Recognized		http://database.ul.com/cgi-bin/XYV/template/LISEXT/1FRAME/index.htm	FILE E 118976
Nominal voltage UN		24 V	
Nominal current IN		3 A	

EAC		EAC-Zulassung
-----	---	---------------

cULus Recognized	
------------------	---

Phoenix Contact 2018 © - all rights reserved
<http://www.phoenixcontact.com>

PHOENIX CONTACT GmbH & Co. KG
Flachsmarktstr. 8
32825 Blomberg
Germany
Tel. +49 5235 300
Fax +49 5235 3 41200
<http://www.phoenixcontact.com>