

Interface module - VIP-2/SC/D 9SUB/M/LED - 2322142

Please be informed that the data shown in this PDF Document is generated from our Online Catalog. Please find the complete data in the user's documentation. Our General Terms of Use for Downloads are valid (<http://phoenixcontact.com/download>)



VARIOFACE module, with screw connection and D-Subminiature pin strip, for mounting on NS 35 rails, with LED, 9-pos.

Your advantages

- 9 to 50-pos.
- Metal foot
- According to IEC 60603-13
- Screw connection
- 1:1 connection



Key Commercial Data

Packing unit	1 pc
GTIN	
GTIN	4046356451765

Technical data

Dimensions

Width	34.7 mm
Height	65.5 mm
Depth	45.1 mm

Ambient conditions

Ambient temperature (operation)	-20 °C ... 50 °C
Ambient temperature (storage/transport)	-20 °C ... 70 °C

General

Nominal voltage U_N	24 V DC
Max. perm. current (per branch)	2.5 A
Number of positions	9

Interface module - VIP-2/SC/D 9SUB/M/LED - 2322142

Technical data

General

Status display	LED
Mounting position	any

Connection data

Connection name	Field level
Connection in acc. with standard	IEC / EN
Connection method	Screw connection
Stripping length	8 mm
Screw thread	M3
Conductor cross section solid	0.2 mm ² ... 4 mm ²
Conductor cross section flexible	0.2 mm ² ... 2.5 mm ²
Conductor cross section AWG	24 ... 12

Connection data 2

Connection name	Controller level
Connection method	D-SUB pin strip
Number of connections	1
Number of positions	9

Standards and Regulations

Connection in acc. with standard	CUL
Standards/regulations	IEC 60664
	DIN EN 50178
Pollution degree	2
Overvoltage category	II
Flammability rating according to UL 94	V0

Environmental Product Compliance

REACH SVHC	Lead 7439-92-1
China RoHS	Environmentally Friendly Use Period = 50 years
	For details about hazardous substances go to tab "Downloads", Category "Manufacturer's declaration"

Drawings

Interface module - VIP-2/SC/D 9SUB/M/LED - 2322142

Dimensional drawing

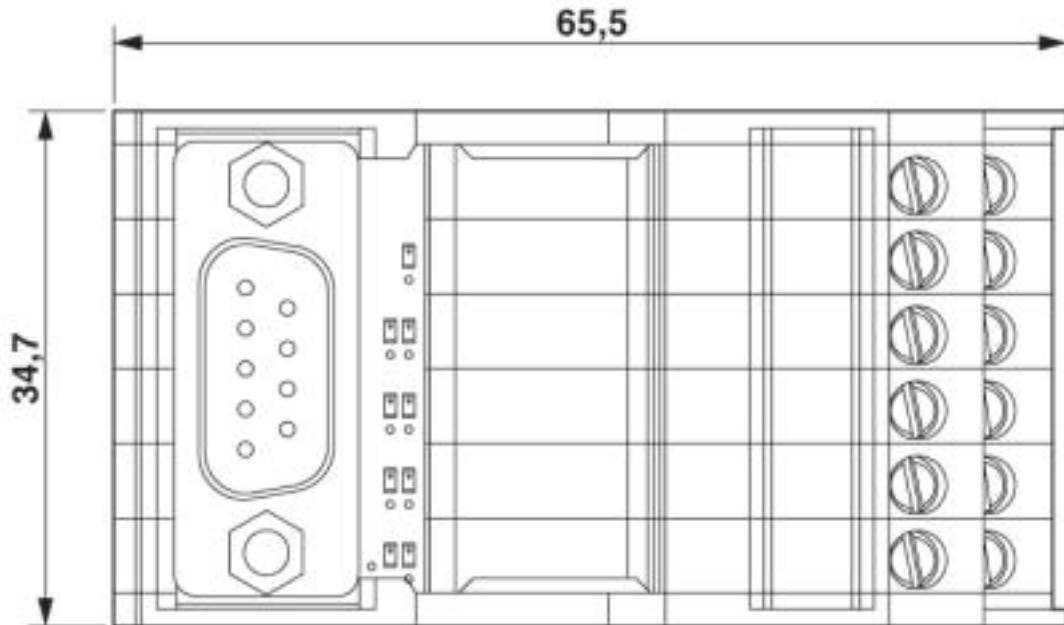

Circuit diagram

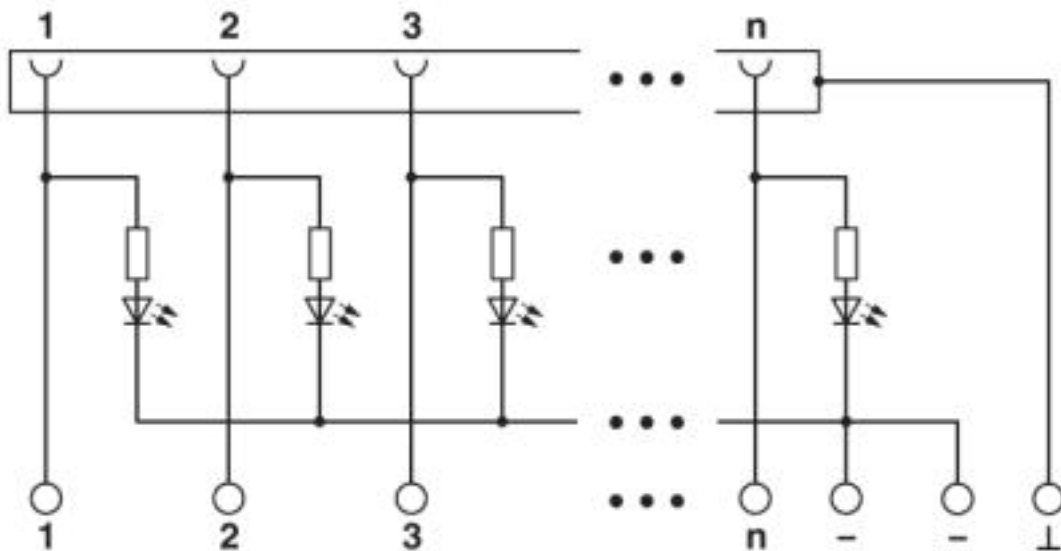

Classifications

eCl@ss

eCl@ss 10.0.1	27141152
eCl@ss 4.0	27250300
eCl@ss 4.1	27250300
eCl@ss 5.0	27250300
eCl@ss 5.1	27250300

Interface module - VIP-2/SC/D 9SUB/M/LED - 2322142

Classifications

eCl@ss

eCl@ss 6.0	27242600
eCl@ss 7.0	27141152
eCl@ss 8.0	27141152
eCl@ss 9.0	27141152

ETIM

ETIM 4.0	EC002780
ETIM 5.0	EC002780
ETIM 6.0	EC002780
ETIM 7.0	EC002780

UNSPSC

UNSPSC 6.01	30211824
UNSPSC 7.0901	39121421
UNSPSC 11	39121421
UNSPSC 12.01	39121421
UNSPSC 13.2	39121432
UNSPSC 18.0	39121432
UNSPSC 19.0	39121432
UNSPSC 20.0	39121432
UNSPSC 21.0	39121432

Approvals

Approvals

Approvals

CSA / EAC / CSAus / UL Recognized / cUL Recognized / cCSAus / cULus Recognized

Ex Approvals

Approval details

CSA		http://www.csagroup.org/services-industries/product-listing/	2122203
Nominal voltage UN		24 V	
Nominal current IN		2 A	
mm ² /AWG/kcmil		28-12	

Interface module - VIP-2/SC/D 9SUB/M/LED - 2322142

Approvals

EAC			RU C- DE.A*30.B.01742
-----	---	--	--------------------------

CSAus		http://www.csagroup.org/services-industries/product-listing/	2122203
Nominal voltage UN		24 V	
Nominal current IN		2 A	
mm ² /AWG/kcmil		28-12	

UL Recognized		http://database.ul.com/cgi-bin/XYV/template/LISEXT/1FRAME/index.htm	FILE E 238705
Nominal voltage UN		24 V	
Nominal current IN		2 A	
mm ² /AWG/kcmil		30-12	

cUL Recognized		http://database.ul.com/cgi-bin/XYV/template/LISEXT/1FRAME/index.htm	FILE E 238705
Nominal voltage UN		24 V	
Nominal current IN		2 A	
mm ² /AWG/kcmil		30-12	

cCSAus			
--------	---	--	--

cULus Recognized			
------------------	---	--	--

Accessories

Accessories

System cable

Interface module - VIP-2/SC/D 9SUB/M/LED - 2322142

Accessories

Cable - CABLE-D 9SUB/B/S/ 50/KONFEK/S - 2299987



Assembled shielded round cable; connection 1: D-SUB socket strip (1x 9-position); connection 2: D-SUB pin strip (1x 9-position); cable length: 0.5 m

Cable - CABLE-D 9SUB/B/S/100/KONFEK/S - 2299990



Assembled shielded round cable; connection 1: D-SUB socket strip (1x 9-position); connection 2: D-SUB pin strip (1x 9-position); cable length: 1 m

Cable - CABLE-D 9SUB/B/S/150/KONFEK/S - 2300009



Assembled shielded round cable; connection 1: D-SUB socket strip (1x 9-position); connection 2: D-SUB pin strip (1x 9-position); cable length: 1.5 m

Cable - CABLE-D 9SUB/B/S/200/KONFEK/S - 2302010



Assembled shielded round cable; connection 1: D-SUB socket strip (1x 9-position); connection 2: D-SUB pin strip (1x 9-position); cable length: 2 m

Cable - CABLE-D 9SUB/B/S/300/KONFEK/S - 2302023



Assembled shielded round cable; connection 1: D-SUB socket strip (1x 9-position); connection 2: D-SUB pin strip (1x 9-position); cable length: 3 m

Interface module - VIP-2/SC/D 9SUB/M/LED - 2322142

Accessories

Cable - CABLE-D 9SUB/B/S/400/KONFEK/S - 2302036



Assembled shielded round cable; connection 1: D-SUB socket strip (1x 9-position); connection 2: D-SUB pin strip (1x 9-position); cable length: 4 m

Cable - CABLE-D 9SUB/B/S/600/KONFEK/S - 2302049



Assembled shielded round cable; connection 1: D-SUB socket strip (1x 9-position); connection 2: D-SUB pin strip (1x 9-position); cable length: 6 m

Cable - CABLE D-SUB-S/.../.../... - 2302340



Shielded round cable, assembled with one D-SUB male and one female connector, variable cable length

Cable - CABLE D-SUB-B-B-S/.../.../... - 2302421



Shielded round cable, assembled with two D-SUB female connectors, variable cable length

Phoenix Contact 2020 © - all rights reserved
<http://www.phoenixcontact.com>

PHOENIX CONTACT GmbH & Co. KG
Flachsmarktstr. 8
32825 Blomberg
Germany
Tel. +49 5235 300
Fax +49 5235 3 41200
<http://www.phoenixcontact.com>