

UDK-RELG 3

Order No.: 2777043

The illustration shows versions with a different no. of positions

<http://eshop.phoenixcontact.de/phoenix/treeViewClick.do?UID=2777043>

Basic termination blocks with test connection on both sides and double connections with the same potential for NS 32 and NS 35/7.5 DIN rail, with end cover, for ST-REL..., ST-OV... and ST-OE... plugs, 3-pos.

Commercial data

GTIN (EAN)	 4 017918 068639
sales group	G003
Pack	10 pcs.
Customs tariff	85369010
Catalog page information	Page 95 (IF-2005)

Product notes

WEEE/RoHS-compliant since:
01/01/2003

<http://www.download.phoenixcontact.com>
Please note that the data given here has been taken from the online catalog. For comprehensive information and data, please refer to the user documentation. The General Terms and Conditions of Use apply to Internet downloads.

Technical data

General data

Number of positions	3
Nominal voltage U_N	400 V (voltage is determined by the coupling connector.)

Nominal current I_N	16 A (current is determined by the coupling connector.)
Color	gray
Insulating material	PA
Width	20.8 mm
Height	63.6 mm
Depth	113 mm

Connection data

Conductor cross section solid min.	0.2 mm ²
Conductor cross section solid max.	4 mm ²
Conductor cross section stranded min.	0.2 mm ²
Conductor cross section stranded max.	4 mm ²
Conductor cross section AWG/kcmil min.	24
Conductor cross section AWG/kcmil max	12
Connection method	Screw connection
Stripping length	7 mm
Screw thread	M3

Certificates / Approvals

Certification

CUL, GOST, UL

Accessories

Item	Designation	Description
Assembly		
1201442	E/UK	End clamp, for assembly on NS 32 or NS 35/7.5 DIN rail
0201595	FB-150 METER	Cross connection rail, for fixed bridging of identical inputs and outputs, made of Cu, nickel-plated, 1 m long
3004207	VS	Connection pin, Length: 1000 mm, Color: gray
2303608	ZSR	Distance piece, metal, for branches of FB-150, with screw and thrust washer

Bridges

2820916	DB 50- 90 BK	Wire bridge, Color: black
2821180	DB 50- 90 BU	Wire bridge, Color: blue
2820929	DB 50- 90 GY	Wire bridge, Color: gray
2961066	KB RELG 2	Fixed bridge, for cross connections, with screw, 2-pos.
2961079	KB RELG 3	Fixed bridge, for cross connections, with screw, 3-pos.
2961082	KB RELG 4	Fixed bridge, for cross connections, with screw, 4-pos.
2961095	KB RELG 7	Fixed bridge, for cross connections, with screw, 7-pos.

Plug/Adapter

0201647	RPS	Reducing plug, Color: gray
---------	-----	----------------------------

Diagrams/Drawings

Dimensioned drawing

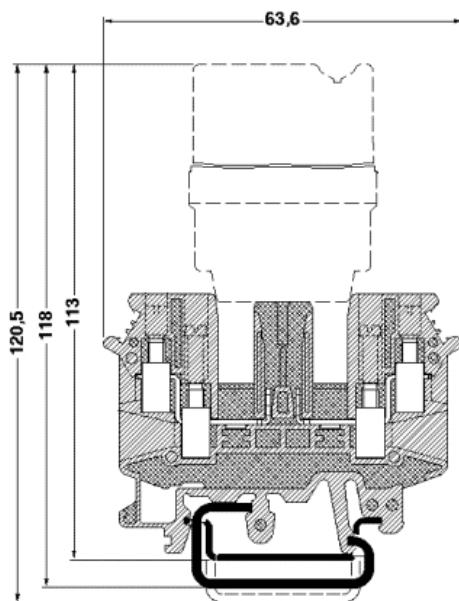

Schematic diagram

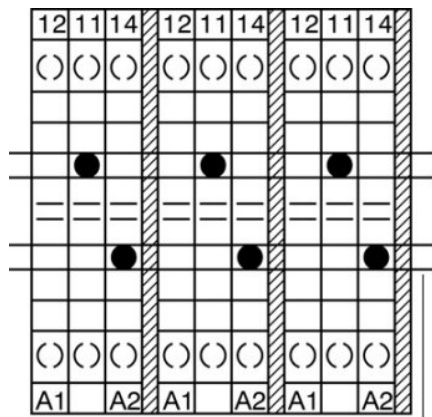

1-3

1-3 = fixed bridge, cross connection rail, spacer

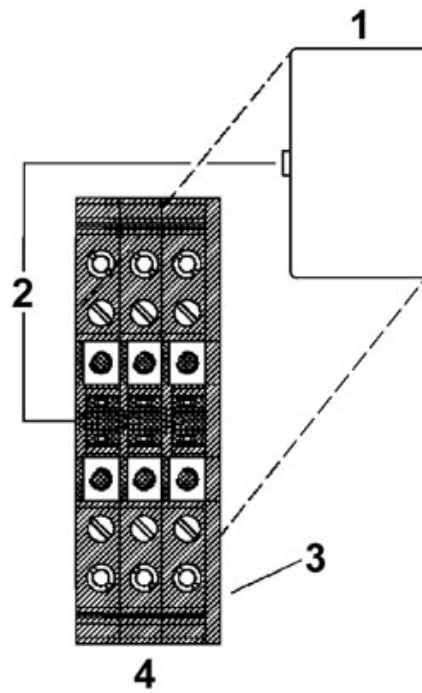

- 1 = Coupling connector
- 2 = Coding
- 3 = Cover
- 4 = Basic termination block

Address

PHOENIX CONTACT Inc., USA
586 Fulling Mill Road
Middletown, PA 17057, USA
Phone (800) 888-7388
Fax (717) 944-1625
<http://www.phoenixcon.com>



© 2011 Phoenix Contact
Technical modifications reserved;