

Surge protection device - PT-IQ-1X2-24DC-PT - 2801255

Please be informed that the data shown in this PDF Document is generated from our Online Catalog. Please find the complete data in the user's documentation. Our General Terms of Use for Downloads are valid (<http://phoenixcontact.com/download>)



Surge protection, consisting of protective plug and base element, with integrated multi-stage status indicator on the module, for one 2-wire floating signal circuit, HART-compatible.



Key Commercial Data

Packing unit	1 pc
GTIN	 4 046356 766388
GTIN	4046356766388

Technical data

Dimensions

Height	109.3 mm
Width	17.7 mm
Depth	77.5 mm (incl. DIN rail 7.5 mm)
Horizontal pitch	1 Div.

Ambient conditions

Ambient temperature (operation)	-40 °C ... 70 °C
Ambient temperature (storage/transport)	-40 °C ... 85 °C
Altitude	≤ 4000 m (amsl (above mean sea level))
Degree of protection	IP20

General

Housing material	PA 6.6
Flammability rating according to UL 94	V-0
Color	jet black RAL 9005
Mounting type	DIN rail: 35 mm
Type	DIN rail module, two-section, divisible

Surge protection device - PT-IQ-1X2-24DC-PT - 2801255

Technical data

General

Direction of action	Line-Line & Line-Signal Ground/Shield & optional Signal Ground/Shield-Earth Ground
---------------------	--

Additional descriptions

Note	Remote signaling as well as the power supply of the DIN rail connector are established by snapping the module into place on the DIN rail connector.
------	---

Protective circuit

IEC test classification	C1
	C2
	C3
	D1
Nominal voltage U_N	24 V DC
Maximum continuous voltage U_C	30 V DC
	21 V AC
Rated current	1000 mA (40 °C)
Operating effective current I_C at U_C	≤ 1 mA (in the signal circuit)
Residual current I_{PE}	≤ 2 μ A (per signal circuit)
Nominal discharge current I_n (8/20) μ s (line-line)	10 kA
Nominal discharge current I_n (8/20) μ s (line-earth)	10 kA
Pulse discharge current I_{imp} (10/350) μ s (line-earth)	2.5 kA
Total discharge current I_{total} (8/20) μ s	20 kA
Voltage protection level U_p (line-line)	≤ 80 V (C1 - 1 kV/500 A)
	≤ 130 V (C2 - 10 kV / 5 kA)
	≤ 55 V (C3 - 25 A)
	≤ 60 V (C3 - 100 A)
Voltage protection level U_p (line-earth)	≤ 600 V (C1 - 1 kV/500 A)
	≤ 750 V (C2 - 10 kV / 5 kA)
	≤ 700 V (C3 - 25 A)
	≤ 800 V (C3 - 100 A)
Voltage protection level U_p static (line-line)	≤ 65 V (C1 - 1 kV/500 A)
Voltage protection level U_p static (line-earth)	≤ 60 V (C2 - 10 kV / 5 kA)
	≤ 40 V (C3 - 25 A)
	≤ 100 V (C3 - 100 A)
Response time t_A (line-line)	≤ 1 ns
Response time t_A (line-earth)	≤ 100 ns
Input attenuation aE, sym.	typ. 0.3 dB (≤ 270 kHz/150 Ω)
Cut-off frequency f_g (3 dB), sym. in 150 Ohm system	typ. 1.1 MHz
Capacity (line-line)	typ. 2 nF
Resistance in series	1.2 $\Omega \pm 5$ %
Surge protection fault message	Optical, multi-stage

Surge protection device - PT-IQ-1X2-24DC-PT - 2801255

Technical data

Protective circuit

Max. required back-up fuse	1 A (FF)
Impulse durability (line-line)	C1 - 1 kV/500 A
	C2 - 10 kV/5 kA
	C2 - 10 kA
Impulse durability (line-earth)	C3 - 100 A
	C1 - 1 kV/500 A
	C2 - 10 kV/5 kA
	C2 - 10 kA
	C3 - 100 A
	D1 - 2.5 kA
Pulse reset time (line-line)	≤ 4000 ms
Pulse reset time (line-earth)	≤ 2600 ms

Connection data

Connection method	Push-in connection
Stripping length	10 mm
Conductor cross section flexible	0.2 mm ² ... 2.5 mm ²
Conductor cross section solid	0.2 mm ² ... 4 mm ²
Conductor cross section AWG	24 ... 12

Connection, equipotential bonding

Connection method	DIN rail NS35
-------------------	---------------

Standards and Regulations

Standards/specifications	IEC 61643-21 2000 + A1:2008 + A2:2012
	EN 61643-21 2001 + A1:2009 + A2:2013
	EN 61000-6-2 2005
	EN 61000-6-3 2007 + A1:2011

Environmental Product Compliance

REACH SVHC	Lead 7439-92-1
------------	----------------

Drawings

Pictogram



Diagram

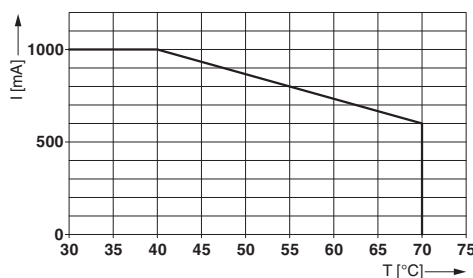

Surge protection device - PT-IQ-1X2-24DC-PT - 2801255

Dimensional drawing

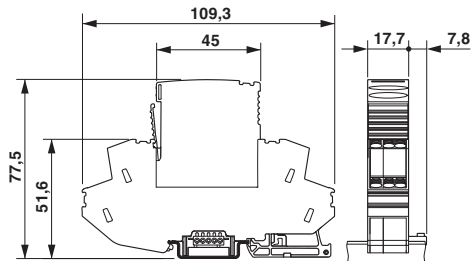

Circuit diagram

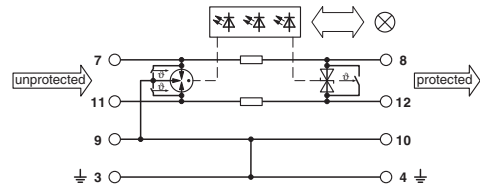

Application drawing

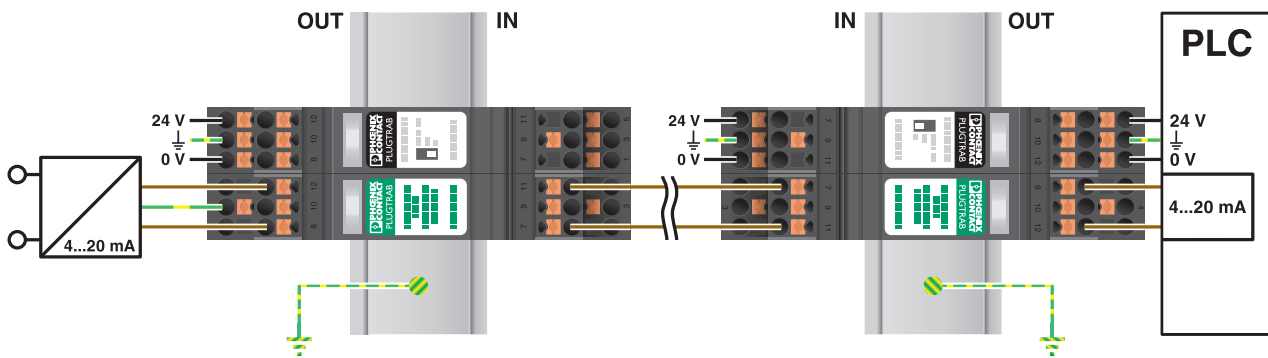

Application drawing

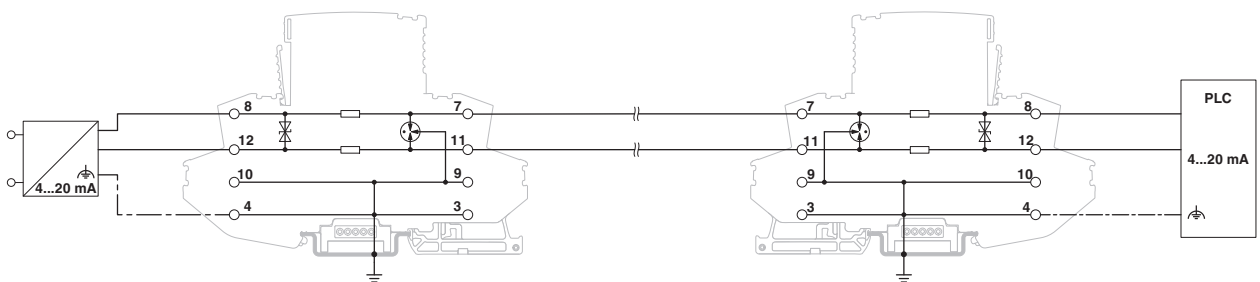

Approvals

Approvals

Approvals

UL Listed / EAC / CSA / CSAus / cCSAus

Surge protection device - PT-IQ-1X2-24DC-PT - 2801255

Approvals

Ex Approvals

Approval details

UL Listed		http://database.ul.com/cgi-bin/XYV/template/LISEXT/1FRAME/index.htm	FILE E 138168
EAC			RU C- DE.A*30.B01561
CSA		http://www.csagroup.org/services-industries/product-listing/	2761632
CSAus		http://www.csagroup.org/services-industries/product-listing/	2761632
cCSAus		http://www.csagroup.org/us/en/services/testing-and-certification/certified-product-listing	

Phoenix Contact 2018 © - all rights reserved
<http://www.phoenixcontact.com>

PHOENIX CONTACT GmbH & Co. KG
Flachsmarktstr. 8
32825 Blomberg
Germany
Tel. +49 5235 300
Fax +49 5235 3 41200
<http://www.phoenixcontact.com>