

C-RCI 10/M8

Order No.: 3240221

<http://eshop.phoenixcontact.de/phoenix/treeViewClick.do?UID=3240221>Ring cable lug, red, 10 mm², M8**Commercial data**

GTIN (EAN)	 4 046356 452113
sales group	B281
Pack	50 pcs.
Customs tariff	85369010
Catalog page information	Page 316 (CL2-2011)

Product notesWEEE/RoHS-compliant since:
09/22/2008

<http://www.download.phoenixcontact.com>
Please note that the data given here has been taken from the online catalog. For comprehensive information and data, please refer to the user documentation. The General Terms and Conditions of Use apply to Internet downloads.

Technical data**General**

Length (b)	37.3 mm
Width (a)	14 mm
Color	red
Ambient temperature (operation)	-20 °C ... 105 °C
Components	Halogen-free

Material	Copper
Length of insulation sleeve (c)	16 mm
Inner dimension of the insulating collar (d)	7.5 mm
Distance between the center and the insulation sleeve (e)	13.8 mm
Inner diameter (f)	8.4 mm
Material thickness (g)	1.1 mm

Diagrams/Drawings

Dimensioned drawing

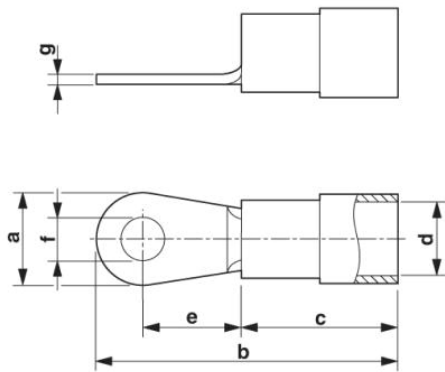

Address

PHOENIX CONTACT Inc., USA
586 Fulling Mill Road
Middletown, PA 17057, USA
Phone (800) 888-7388
Fax (717) 944-1625
<http://www.phoenixcon.com>



© 2011 Phoenix Contact
Technical modifications reserved;