

Distributed by:

JAMECO[®]
ELECTRONICS

www.Jameco.com ♦ 1-800-831-4242

The content and copyrights of the attached
material are the property of its owner.

Jameco Part Number 1822655

FEATURES:

- ✓ This adapter provides a banana jack connection by replacing the screw in a terminal strip.
- ✓ Secure connections can be made with standard banana plug patch cords without breaking the connection to the terminal strip.
- ✓ Standard banana jack .166" and 4mm.

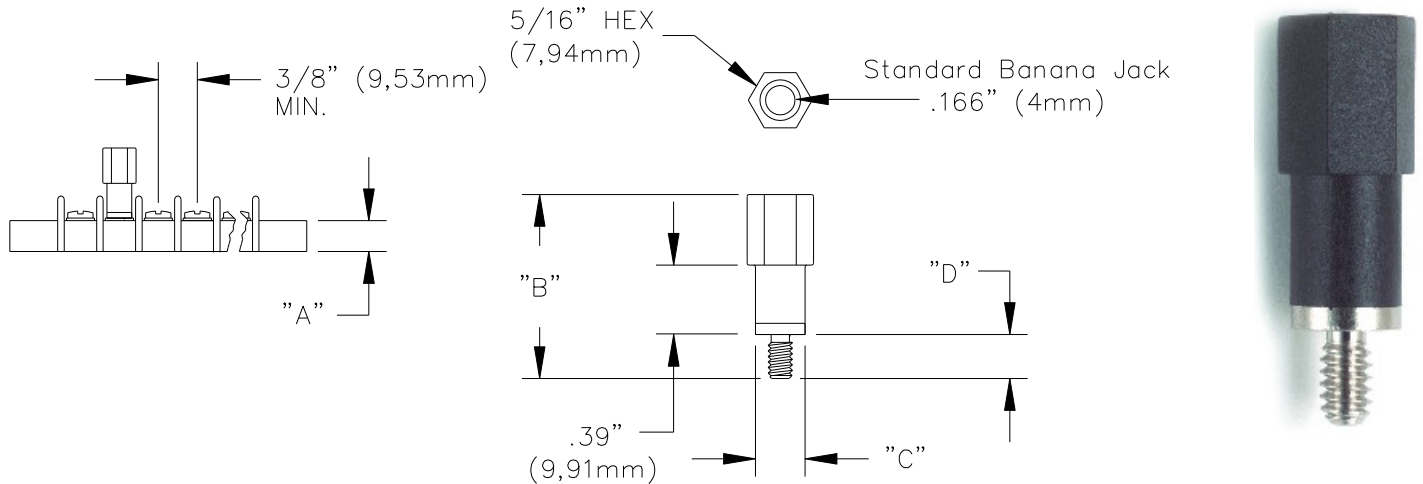

Model	Dim "A"	Dim "B"	Dim "C"	Dim "D"	Thread	Torque In/Lb	Vrms Max
5699	.35" min (8,89mm)	1.04" (26,42mm)	.28" (7,11mm)	.25" (6,35mm)	6-32	7	1100
5700	.44" min (11,18mm)	1.13" (28,70mm)	.38 (9,65mm)	.32" (8,13mm)	8-32	16	1600
5701	.50" min (12,70mm)	1.13" (28,70mm)	.38 (9,65mm)	.32" (8,13mm)	10-32	25	1700

RATINGS:

Operating Voltage see table:

Hands free usage in controlled voltage environments. *For CE compliance:* not intended for hand-held use at voltages above 33 Vrms/70 Vdc.

Current: 25Amps Max

Power: 7500 Watts Max

Operating Temperature: +216°F (+102°C) Max.

MATERIALS:

Banana Jack and Threaded Stud: Nickel Plated Brass, Alloy 360, ½ Hard per MIL-C-26074, Class 1 200/300 microinches:
Insulation : Nylon 6, 20% glass filled

ORDERING INFORMATION:

Model: 5699-**Color** (6-32 thread)

Model: 5700-**Color** (8-32 thread)

Model: 5701-**Color** (10-32 thread)

Color = 0 (Black), 2 (Red), 3 (Orange), 4 (Yellow), 5 (Green), 6 (Blue), 9 (White)

All dimensions are in inches. Tolerances (except noted): .xx = ±.02" (.51 mm), .xxx = ±.005" (.127 mm).

All specifications are to the latest revisions. Specifications are subject to change without notice.

Registered trademarks are the property of their respective companies.

Sales: 800-490-2361 Fax: 888-403-3360 Technical Support: 800-241-2060 (technicalsupport@pomonatest.com)

For "Where to Buy" information, visit the Pomona web site at www.pomonaelectronics.com