

H11F1 H11F2 H11F3

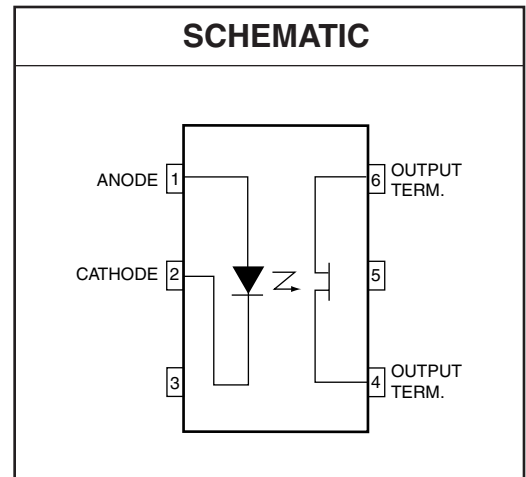
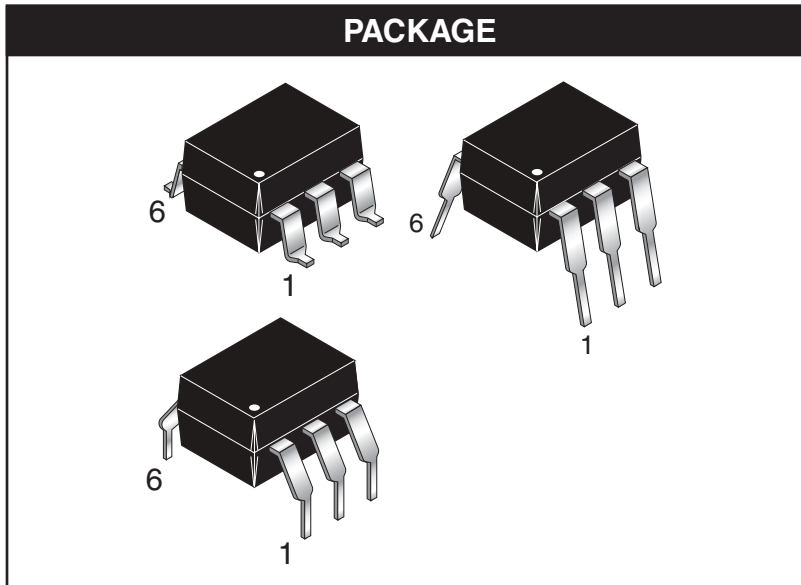

DESCRIPTION

The H11F series consists of a Gallium-Aluminum-Arsenide IRED emitting diode coupled to a symmetrical bilateral silicon photo-detector. The detector is electrically isolated from the input and performs like an ideal isolated FET designed for distortion-free control of low level AC and DC analog signals. The H11F series devices are mounted in dual in-line packages.

FEATURES

As a remote variable resistor

- $\leq 100\Omega$ to $\geq 300\text{ M}\Omega$
- $\geq 99.9\%$ linearity
- $\leq 15\text{ pF}$ shunt capacitance
- $\geq 100\text{ G}\Omega$ I/O isolation resistance

As an analog switch

- Extremely low offset voltage
- $60\text{ V}_{\text{pk-pk}}$ signal capability
- No charge injection or latch-up
- $t_{\text{on}}, t_{\text{off}} \leq 15\text{ }\mu\text{S}$
- UL recognized (File #E90700)
- VDE recognized (File #E94766)
 - Ordering option '300' (e.g. H11F1.300)

APPLICATIONS

As a variable resistor –

- Isolated variable attenuator
- Automatic gain control
- Active filter fine tuning/band switching

As an analog switch –

- Isolated sample and hold circuit
- Multiplexed, optically isolated A/D conversion

H11F1 H11F2 H11F3

| Absolute Maximum Ratings ($T_A = 25^\circ\text{C}$ unless otherwise specified) | | | | |
|---|-------------|--------------|----------------|----------------------|
| Parameter | Symbol | Device | Value | Units |
| TOTAL DEVICE | | | | |
| Storage Temperature | T_{STG} | All | -55 to +150 | $^\circ\text{C}$ |
| Operating Temperature | T_{OPR} | All | -55 to +100 | $^\circ\text{C}$ |
| Lead Solder Temperature | T_{SOL} | All | 260 for 10 sec | $^\circ\text{C}$ |
| EMITTER | | | | |
| Continuous Forward Current | I_F | All | 60 | mA |
| Reverse Voltage | V_R | All | 5 | V |
| Forward Current - Peak (10 μs pulse, 1% duty cycle) | $I_{F(pk)}$ | All | 1 | A |
| LED Power Dissipation 25°C Ambient Derate Linearly From 25°C | P_D | All | 100 | mW |
| | | | 1.33 | mW/ $^\circ\text{C}$ |
| DETECTOR | | | | |
| Detector Power Dissipation @ 25°C Derate linearly from 25°C | P_D | All | 300 | mW |
| | | | 4.0 | mW/ $^\circ\text{C}$ |
| Breakdown Voltage (either polarity) | BV_{4-6} | H11F1, H11F2 | ± 30 | V |
| | | H11F3 | ± 15 | V |
| Continuous Detector Current (either polarity) | I_{4-6} | All | ± 100 | mA |

ELECTRICAL CHARACTERISTICS ($T_A = 25^\circ\text{C}$ Unless otherwise specified.)

| INDIVIDUAL COMPONENT CHARACTERISTICS | | | | | | | |
|---|--|------------|--------------|-----|------|------|---------------|
| Parameter | Test Conditions | Symbol | Device | Min | Typ* | Max | Unit |
| EMITTER | | | | | | | |
| Input Forward Voltage | $I_F = 16 \text{ mA}$ | V_F | All | | 1.3 | 1.75 | V |
| Reverse Leakage Current | $V_R = 5 \text{ V}$ | I_R | All | | | 10 | μA |
| Capacitance | $V = 0 \text{ V}, f = 1.0 \text{ MHz}$ | C_J | All | | 50 | | pF |
| OUTPUT DETECTOR | | | | | | | |
| Breakdown Voltage Either Polarity | $I_{4-6} = 10\mu\text{A}, I_F = 0$ | BV_{4-6} | H11F1, H11F2 | 30 | | | V |
| | | | H11F3 | 15 | | | |
| Off-State Dark Current | $V_{4-6} = 15 \text{ V}, I_F = 0$ | I_{4-6} | All | | | 50 | nA |
| | $V_{4-6} = 15 \text{ V}, I_F = 0, T_A = 100^\circ\text{C}$ | | All | | | 50 | μA |
| Off-State Resistance | $V_{4-6} = 15 \text{ V}, I_F = 0$ | R_{4-6} | All | 300 | | | M Ω |
| Capacitance | $V_{4-6} = 15 \text{ V}, I_F = 0, f = 1\text{MHz}$ | C_{4-6} | All | | | 15 | pF |

H11F1 H11F2 H11F3

ISOLATION CHARACTERISTICS

| Parameter | Test Conditions | Symbol | Min | Typ* | Max | Units |
|--------------------------------|-----------------------------------|------------------|------------------|------|-----|-----------|
| Input-Output Isolation Voltage | f = 60Hz, t = 1 min. | V _{ISO} | 5300 | | | Vac (rms) |
| Isolation Resistance | V _{I-O} = 500 VDC | R _{ISO} | 10 ¹¹ | | | Ω |
| Isolation Capacitance | V _{I-O} = 0, f = 1.0 MHz | C _{ISO} | | | 2 | pF |

TRANSFER CHARACTERISTICS (T_A = 25°C Unless otherwise specified.)

| DC Characteristics | Test Conditions | Symbol | Device | Min | Typ* | Max | Units |
|---|--|------------------|--------|-----|------|-----|-------|
| On-State Resistance | I _F = 16 mA, I ₄₋₆ = 100 μA | R ₄₋₆ | H11F1 | | | 200 | Ω |
| | | | H11F2 | | | 330 | |
| | | | H11F3 | | | 470 | |
| On-State Resistance | I _F = 16 mA, I ₆₋₄ = 100 μA | R ₆₋₄ | H11F1 | | | 200 | Ω |
| | | | H11F2 | | | 330 | |
| | | | H11F3 | | | 470 | |
| Resistance, non-linearity and assymetry | I _F = 16mA, I ₄₋₆ = 25 μA RMS, f = 1kHz | | All | | | 0.1 | % |
| AC Characteristics | Test Conditions | Symbol | Device | Min | Typ* | Max | Units |
| Turn-On Time | R _L = 50Ω, I _F = 16mA, V ₄₋₆ = 5V | t _{on} | All | | | 25 | μS |
| Turn-Off Time | R _L = 50Ω, I _F = 16mA, V ₄₋₆ = 5V | t _{off} | All | | | 25 | μS |

H11F1 H11F2 H11F3

Figure 1. Resistance vs. Input Current

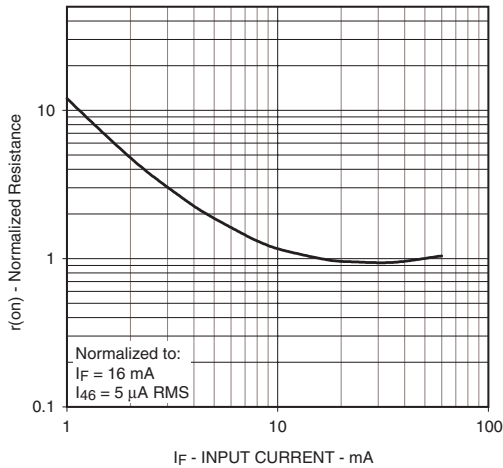

Figure 2. Output Characteristics

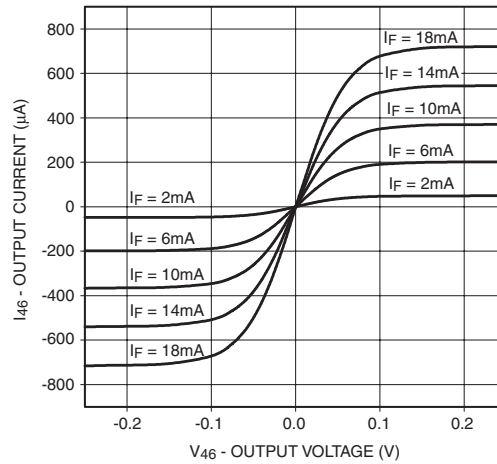

Figure 3. LED Forward Voltage vs. Forward Current

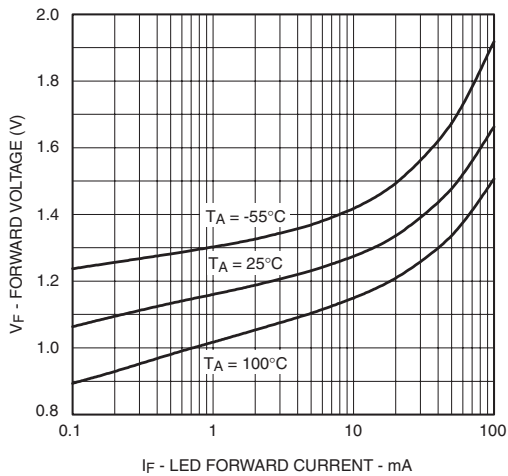

Figure 4. Off-state Current vs. Ambient Temperature

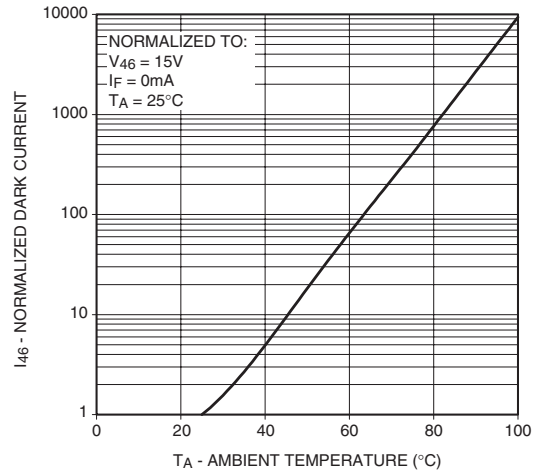

Figure 5. Resistance vs. Temperature

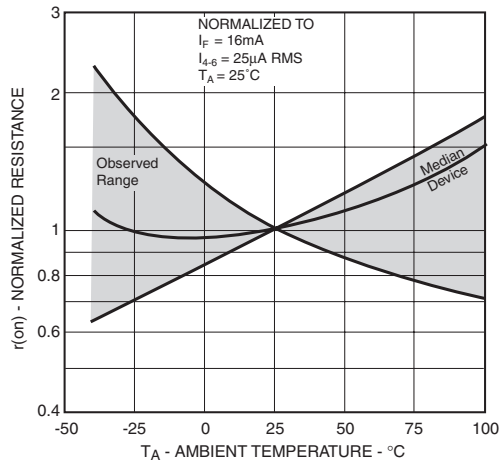

Figure 6. Region of Linear Resistance

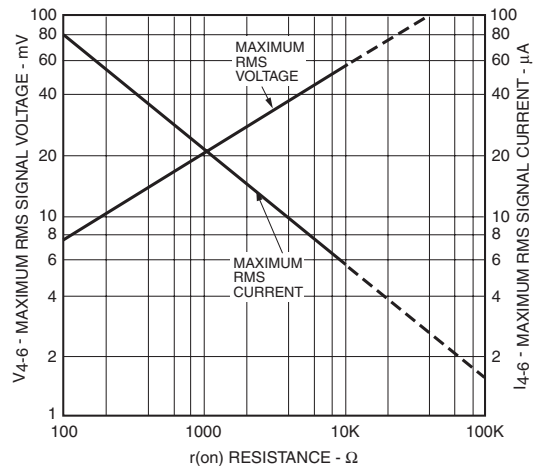
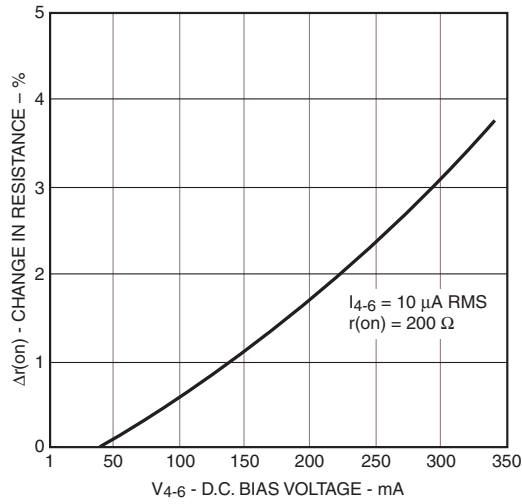

Figure 7. Resistive non-linearity vs. D.C. Bias



TYPICAL APPLICATIONS

AS A VARIABLE RESISTOR

ISOLATED VARIABLE ATTENUATORS

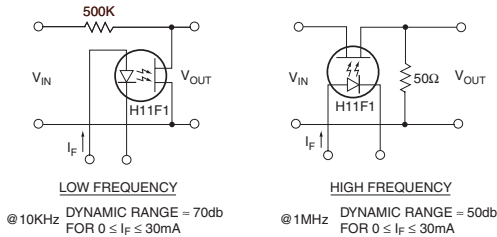

Distortion free attenuation of low level A.C. signals is accomplished by varying the IRED current, I_F . Note the wide dynamic range and absence of coupling capacitors; D.C. level shifting or parasitic feedback to the controlling function.

AS AN ANALOG SIGNAL SWITCH

ISOLATED SAMPLE AND HOLD CIRCUIT

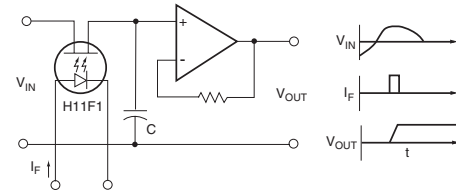

Accuracy and range are improved over conventional FET switches because the H11F has no charge injection from the control signal. The H11F also provides switching of either polarity input signal up to 30V magnitude.

AUTOMATIC GAIN CONTROL

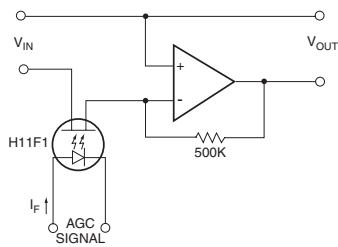

This simple circuit provides over 70db of stable gain control for an AGC signal range of from 0 to 30mA. This basic circuit can be used to provide programmable fade and attack for electronic music.

MULTIPLEXED, OPTICALLY-ISOLATED A/D CONVERSION

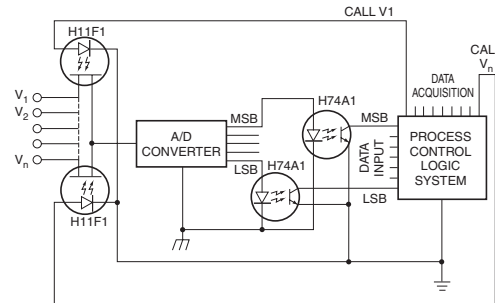

The optical isolation, linearity and low offset voltage of the H11F allows the remote multiplexing of low level analog signals from such transducers as thermocouples, Hall effect devices, strain gauges, etc. to a single A/D converter.

ACTIVE FILTER FINE TUNING/BAND SWITCHING

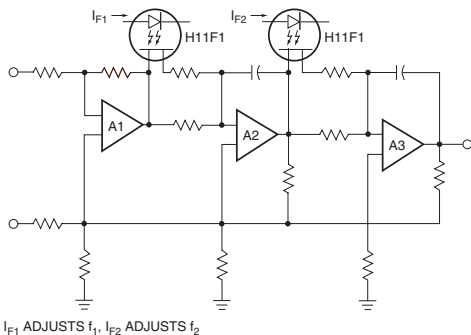

The linearity of resistance and the low offset voltage of the H11F allows the remote tuning or band-switching of active filters without switching glitches or distortion. This schematic illustrates the concept, with current to the H11F1 IRED's controlling the filter's transfer characteristic.

TEST EQUIPMENT - KELVIN CONTACT POLARITY

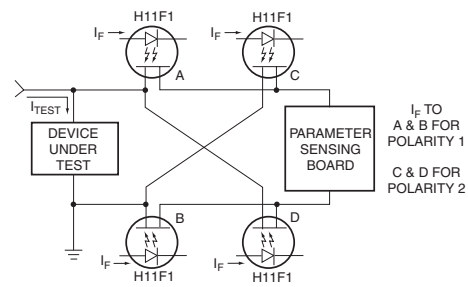

In many test equipment designs the auto polarity function uses reed relay contacts to switch the Kelvin Contact polarity. These reeds are normally one of the highest maintenance cost items due to sticking contacts and mechanical problems. The totally solid-State H11F eliminates these troubles while providing faster switching.

ORDERING INFORMATION

| Option | Order Entry Identifier | Description |
|--------|------------------------|--|
| S | .S | Surface Mount Lead Bend |
| SD | .SD | Surface Mount; Tape and Reel |
| W | .W | 0.4" Lead Spacing |
| 300 | .300 | VDE 0884 |
| 300W | .300W | VDE 0884, 0.4" Lead Spacing |
| 3S | .3S | VDE 0884, Surface Mount |
| 3SD | .3SD | VDE 0884, Surface Mount, Tape and Reel |

MARKING INFORMATION

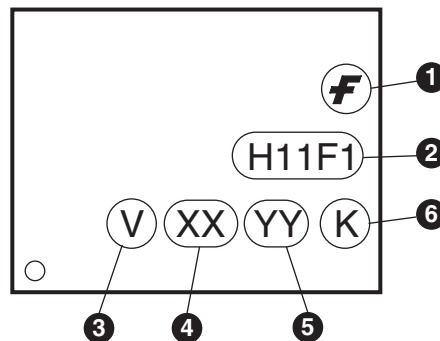

| Definitions | |
|-------------|--|
| 1 | Fairchild logo |
| 2 | Device number |
| 3 | VDE mark (Note: Only appears on parts ordered with VDE option – See order entry table) |
| 4 | Two digit year code, e.g., '03' |
| 5 | Two digit work week ranging from '01' to '53' |
| 6 | Assembly package code |

Carrier Tape Specifications

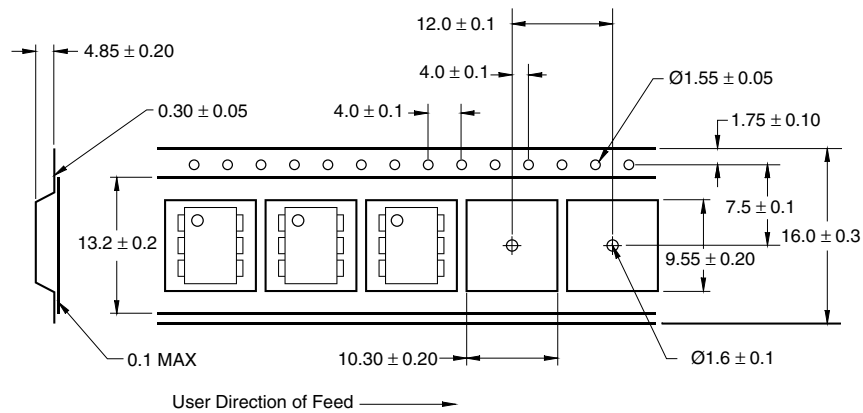

NOTE

All dimensions are in inches (millimeters)

Tape and reel quantity is 1,000 units per reel

Reflow Profile (Black Package, No Suffix)

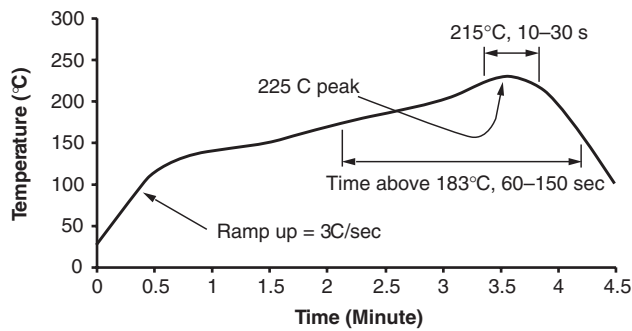

- Peak reflow temperature: 225°C (package surface temperature)
- Time of temperature higher than 183°C for 60–150 seconds
- One time soldering reflow is recommended

DISCLAIMER

FAIRCHILD SEMICONDUCTOR RESERVES THE RIGHT TO MAKE CHANGES WITHOUT FURTHER NOTICE TO ANY PRODUCTS HEREIN TO IMPROVE RELIABILITY, FUNCTION OR DESIGN. FAIRCHILD DOES NOT ASSUME ANY LIABILITY ARISING OUT OF THE APPLICATION OR USE OF ANY PRODUCT OR CIRCUIT DESCRIBED HEREIN; NEITHER DOES IT CONVEY ANY LICENSE UNDER ITS PATENT RIGHTS, NOR THE RIGHTS OF OTHERS.

LIFE SUPPORT POLICY

FAIRCHILD'S PRODUCTS ARE NOT AUTHORIZED FOR USE AS CRITICAL COMPONENTS IN LIFE SUPPORT DEVICES OR SYSTEMS WITHOUT THE EXPRESS WRITTEN APPROVAL OF THE PRESIDENT OF FAIRCHILD SEMICONDUCTOR CORPORATION. As used herein:

1. Life support devices or systems are devices or systems which, (a) are intended for surgical implant into the body, or (b) support or sustain life, and (c) whose failure to perform when properly used in accordance with instructions for use provided in the labeling, can be reasonably expected to result in a significant injury of the user.
2. A critical component in any component of a life support device or system whose failure to perform can be reasonably expected to cause the failure of the life support device or system, or to affect its safety or effectiveness.

Home >> Find products >>

H11F1

6-Pin DIP Bilateral Analog FET Output Optocoupler

Contents

- [General description](#)
- [Features](#)
- [Applications](#)
- [Ordering information](#)
- [Product status/pricing/packaging](#)
- [Order Samples](#)
- [Safety agency certificates](#)
- [Qualification Support](#)

General description

The H11F series consists of a Gallium-Aluminum-Arsenide IRED emitting diode coupled to a symmetrical bilateral silicon photo-detector. The detector is electrically isolated from the input and performs like an ideal isolated FET designed for distortion-free control of low level AC and DC analog signals. The H11F series devices are mounted in dual in-line packages.

[back to top](#)

Features

As a remote variable resistor:

- $\leq 100 \Omega$ to $\geq 300 M\Omega$
- $\geq 99.9\%$ linearity
- ≤ 15 pF shunt capacitance
- $\geq 100 G\Omega$ I/O isolation resistance

As an analog switch:

- Extremely low offset voltage
- $60 V_{pk-pk}$ signal capability
- No charge injection or latchup

BUY

Datasheet

[Download this datasheet](#)



[e-mail this datasheet](#)



This page

[Print version](#)

Related Links

[Request samples](#)

[How to order products](#)

[Product Change Notices \(PCNs\)](#)

[Support](#)

[Sales support](#)

[Quality and reliability](#)

[Design center](#)

- $t_{on}, t_{off} \leq 15\mu s$
- UL recognized (File #E90700)
- VDE recognized (File #E94766)
 - Ordering option '300' (e.g. H11F1.300)

[back to top](#)

Applications

As a variable resistor:

- Isolated variable attenuator
- Automatic gain control
- Active filter fine tuning/band switching

As an analog switch:

- Isolated sample and hold circuit
- Multiplexed, optically isolated A/D conversion

[back to top](#)

Ordering information

The following options can be ordered with this part:







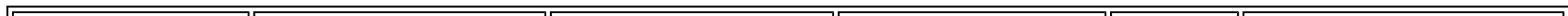

| Option | Order Entry Identifier | Description |
|--------|------------------------|--|
| S | .S | Surface Mount Lead Bend |
| SD | .SD | Surface Mount; Tape and Reel |
| W | .W | 0.4" Lead Spacing |
| 300 | .300 | VDE 0884 |
| 300W | .300W | VDE 0884; 0.4" Lead Spacing |
| 3S | .3S | VDE 0884, Surface Mount |
| 3SD | .3SD | VDE 0884, Surface Mount, Tape and Reel |

[back to top](#)

Product status/pricing/packaging

BUY



| Product | Product status | Pb-free Status | Package type | Leads | Packing method |
|-----------|----------------|---|--------------|-------|----------------|
| H11F1 | Lifetime Buy |  | DIP-B | 6 | BULK |
| H11F1300 | Lifetime Buy |  | DIP-B | 6 | BULK |
| H11F1300W | Lifetime Buy |  | DIP-B | 6 | BULK |
| H11F13S | Lifetime Buy |  | SMDIP-B | 6 | BULK |
| H11F13SD | Lifetime Buy |  | SMDIP-B | 6 | TAPE REEL |
| H11F1S | Lifetime Buy |  | SMDIP-B | 6 | BULK |
| H11F1SD | Lifetime Buy |  | SMDIP-B | 6 | TAPE REEL |
| H11F1W | Lifetime Buy |  | DIP-B | 6 | BULK |



Indicates product with Pb-free second-level interconnect. For more information [click here](#).

[back to top](#)

Safety agency certificates

| Certificate | Agency | |
|--|-----------|--------------------------------------|
| E90700, Vol. 1 (936 K) | UL (1577) | Underwriters Laboratories Inc. |
| E90700, Vol. 1 (936 K) | C-UL | Underwriters Laboratories Inc. |
| 0122085 (677 K) | SEMKO | SEMKO |
| P01101067 (1638 K) | NEMKO | NEMKO |
| FI 16812 (964 K) | FIMKO | FIMKO |
| 310684-02 (623 K) | DEMKO | DEMKO Testing & Certification |
| 1027742 (2305 K) | CSA | Canadian Standards Association |
| 94766 (1673 K) | VDE | VDE Pruf-und Zertifizierungsinstitut |

[back to top](#)

Qualification Support

Click on a product for detailed qualification data

| Product |
|---------------------------|
| H11F1 |
| H11F1300 |
| H11F1300W |
| H11F13S |
| H11F13SD |
| H11F1S |
| H11F1SD |
| H11F1W |

[back to top](#)

© 2007 Fairchild Semiconductor



[Products](#) | [Design Center](#) | [Support](#) | [Company News](#) | [Investors](#) | [My Fairchild](#) | [Contact Us](#) | [Site Index](#) | [Privacy Policy](#) | [Site Terms & Conditions](#) | [Standard Terms & Conditions](#) | [Contact Us](#)