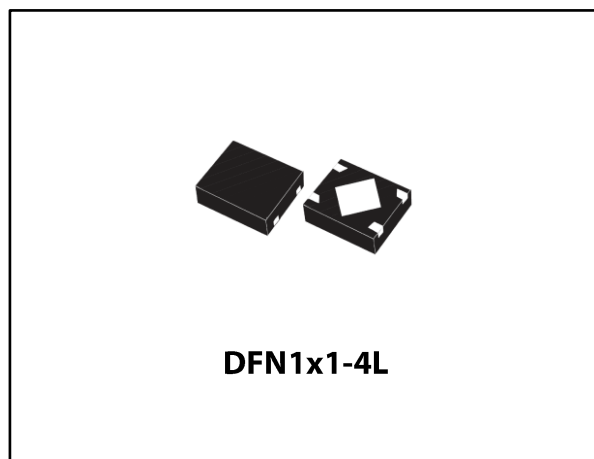


## 200 mA very low quiescent current linear regulator IC

Datasheet - production data



## Features

- Input voltage from 1.5 to 5.5 V
- Ultra low dropout voltage (200 mV typ. at 200 mA load)
- Very low quiescent current (20  $\mu$ A typ at no load, 0.03  $\mu$ A typ in off mode)
- Output voltage tolerance:  $\pm 0.5$  % (A version) or  $\pm 2.0$  % @ 25 °C (standard version)
- 200 mA guaranteed output current
- High PSRR (80 dB@1 kHz, 50 db@100 kHz)
- Wide range of output voltages available on request: from 0.8 V up to 5.0 V in 50 mV step
- Logic-controlled electronic shutdown
- Internal soft-start
- Optional output voltage discharge feature
- Compatible with ceramic capacitor  $C_{OUT} = 0.47 \mu$ F

- Internal constant current and thermal protections
- Available in DFN 1x1-4L
- Operating temperature range: -40 °C to 125 °C

## Applications

- Mobile phones
- Personal digital assistants (PDAs)
- Digital still cameras (DSC)
- Cordless phones and similar battery-powered systems
- Portable media players

## Description

The LD39020 high accuracy voltage regulator provides 200 mA of maximum current from an input voltage ranging from 1.5 V to 5.5 V, with a typical dropout voltage of 200 mV.

It is available in DFN 1x1-4L package, allowing the maximum space saving.

The device is stabilized with a ceramic capacitor on the output. The ultra low drop voltage, low quiescent current and low noise features, together with the internal soft-start circuit, make the LD39020 suitable for low power battery-operated applications.

An enable logic control function puts the LD39020 in shutdown mode allowing a total current consumption lower than 0.1  $\mu$ A. Constant current and thermal protection are provided.

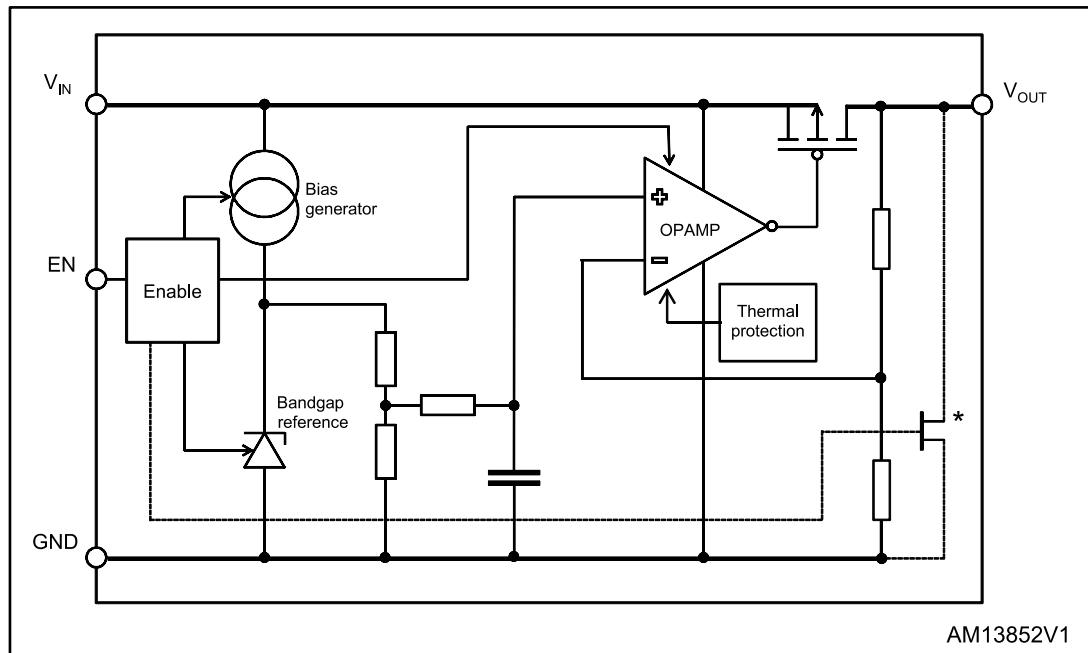
---

**Contents**

<b>1</b>	<b>Diagram</b> .....	<b>3</b>
<b>2</b>	<b>Pin configuration</b> .....	<b>4</b>
<b>3</b>	<b>Typical application</b> .....	<b>5</b>
<b>4</b>	<b>Maximum ratings</b> .....	<b>6</b>
<b>5</b>	<b>Electrical characteristics</b> .....	<b>7</b>
<b>6</b>	<b>Application information</b> .....	<b>10</b>
	6.1    Soft start function .....	10
	6.2    Output discharge function .....	10
	6.3    Input and output capacitors .....	10
<b>7</b>	<b>Typical characteristics</b> .....	<b>11</b>
<b>8</b>	<b>Package mechanical data</b> .....	<b>16</b>
	8.1    DFN 1x1-4L package info .....	16
<b>9</b>	<b>Order codes</b> .....	<b>19</b>
<b>10</b>	<b>Revision history</b> .....	<b>22</b>

# 1 Diagram

Figure 1: Block diagram



The output discharge MOSFET is optional.

## 2 Pin configuration

Figure 2: Pin connection (top view)

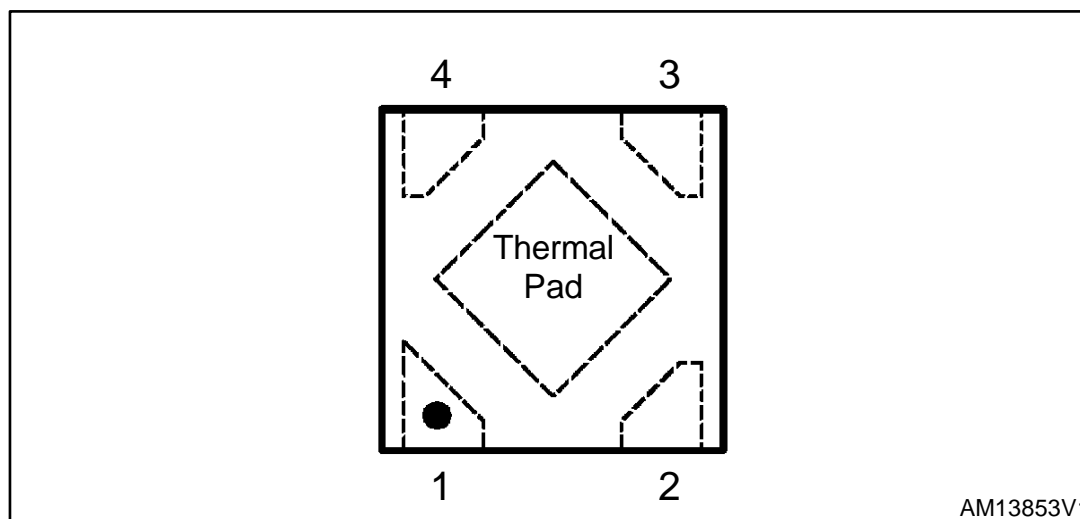
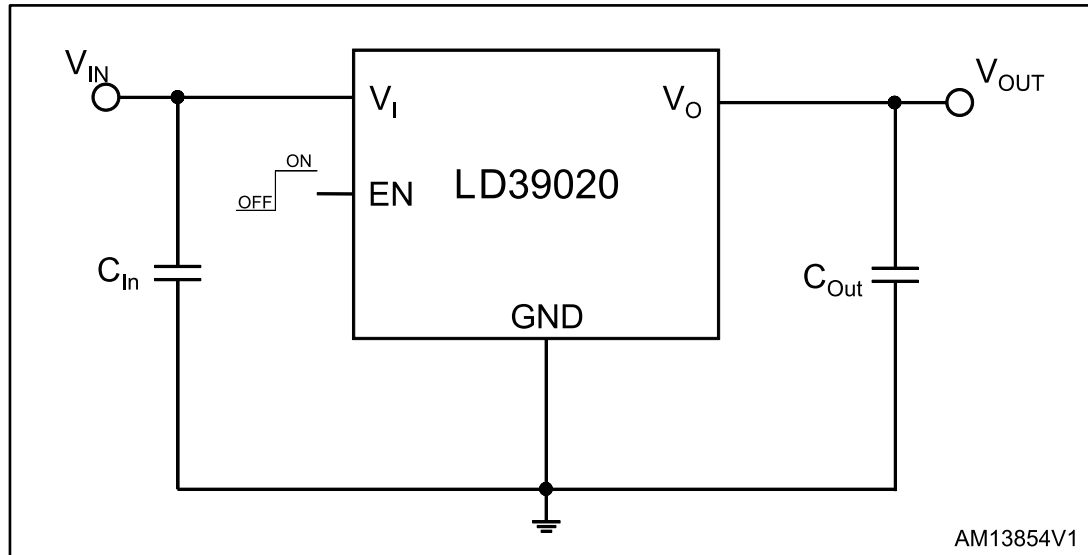


Table 1: Pin description

Pin n°	Symbol	Function
1	OUT	Output voltage
2	GND	Common ground
3	EN	Enable pin logic input: Low = shutdown, High = active
4	IN	Input voltage
Thermal pad	GND	Connect to GND on the PCB

### 3 Typical application

Figure 3: Typical application circuits



## 4 Maximum ratings

Table 2: Absolute maximum ratings

Symbol	Parameter	Value	Unit
$V_{IN}$	Input voltage	- 0.3 to 7	V
$V_{OUT}$	Output voltage	- 0.3 to $V_{IN} + 0.3$	V
$V_{EN}$	Enable input voltage	- 0.3 to 7	V
$I_{OUT}$	Output current	Internally limited	mA
$P_D$	Power dissipation	Internally limited	mW
$T_{STG}$	Storage temperature range	- 40 to 150	°C
$T_{OP}$	Operating junction temperature range	- 40 to 125	°C



Absolute maximum ratings are those values beyond which damage to the device may occur. Functional operation under these conditions is not implied. All values are referred to GND

Table 3: Thermal data

Symbol	Parameter	Value	Unit
$R_{thJA}$	Thermal resistance junction-ambient	250	°C/W

Table 4: ESD Performance

Symbol	Parameter	Test conditions	Value	Unit
ESD	ESD Protection voltage	HBM	4	kV
		MM	400	V
		CDM	500	V

## 5 Electrical characteristics

$T_J = 25\text{ °C}$ ,  $V_{IN} = V_{OUT(NOM)} + 1\text{ V}$ ,  $C_{IN} = C_{OUT} = 1\text{ }\mu\text{F}$ ,  $I_{OUT} = 1\text{ mA}$ ,  $V_{EN} = V_{IN}$ , unless otherwise specified.

Table 5: Electrical characteristics for LD39020T, LD39020DT

Symbol	Parameter	Test conditions	Min.	Typ.	Max.	Unit
$V_{IN}$	Operating input voltage		1.5		5.5	V
$V_{OUT}$	$V_{OUT}$ accuracy	$I_{OUT} = 1\text{ mA}$ , $T_J = 25\text{ °C}$	-2		2	%
		$I_{OUT} = 1\text{ mA}$ , $-40\text{ °C} < T_J < 125\text{ °C}$	-3		3	%
$\Delta V_{OUT}$	Static line regulation <sup>(1)</sup>	$V_{OUT(NOM)} + 1\text{ V} \leq V_{IN} \leq 5.5\text{ V}$ , $I_{OUT} = 10\text{ mA}$		0.02		%/V
		$-40\text{ °C} < T_J < 125\text{ °C}$			0.2	
$\Delta V_{OUT}$	Static load regulation	$I_{OUT} = 0\text{ mA to } 200\text{ mA}$		10		mV
		$-40\text{ °C} < T_J < 125\text{ °C}$			0.01	%/mA
$V_{DROP}$	Dropout voltage	$I_{OUT} = 30\text{ mA}$ , $V_{OUT} = 2.8\text{ V}$		35		mV
		$I_{OUT} = 200\text{ mA}$ , $V_{OUT} = 2.8\text{ V}$ $-40\text{ °C} < T_J < 125\text{ °C}$		200	350	
$e_N$	Output noise voltage	10 Hz to 100 kHz, $I_{OUT} = 10\text{ mA}$		45		$\mu\text{V}_{RMS}$
SVR	Supply voltage rejection	$V_{IN} = V_{OUT(NOM)} + 1\text{ V} \pm V_{RIPPLE}$ $V_{RIPPLE} = 0.2\text{ V Freq.} = 1\text{ kHz}$ $I_{OUT} = 30\text{ mA}$		80		dB
		$V_{IN} = V_{OUT(NOM)} + 1\text{ V} \pm V_{RIPPLE}$ $V_{RIPPLE} = 0.2\text{ V Freq.} = 100\text{ kHz}$ $I_{OUT} = 30\text{ mA}$		55		
$I_Q$	Quiescent current	$I_{OUT} = 0\text{ mA}$		20	40	$\mu\text{A}$
		$I_{OUT} = 200\text{ mA}$		100		
$I_{Standby}$	Standby current	$V_{IN}$ input current in OFF MODE: $V_{EN} = \text{GND}$		0.03	1	$\mu\text{A}$
$I_{SC}$	Short circuit current	$R_L = 0$	250	350		mA
$R_{ON}$	Output voltage discharge MOSFET	(only on LD39020DT)		100		$\Omega$
$V_{EN}$	Enable input logic low	$V_{IN} = 1.5\text{ V to } 5.5\text{ V}$ $-40\text{ °C} < T_J < 125\text{ °C}$			0.4	V
	Enable input logic high	$V_{IN} = 1.5\text{ V to } 5.5\text{ V}$ $-40\text{ °C} < T_J < 125\text{ °C}$	1			
$I_{EN}$	Enable pin input current	$V_{EN} = V_{IN}$			100	nA
$T_{ON}^{(2)}$	Turn on time			100		$\mu\text{s}$
$T_{SHDN}$	Thermal shutdown			160		$^{\circ}\text{C}$
	Hysteresis			20		

Symbol	Parameter	Test conditions	Min.	Typ.	Max.	Unit
C <sub>OUT</sub>	Output capacitor	Capacitance (see <a href="#">Figure 17: "Stability area vs (C<sub>OUT</sub>, ESR)"</a> )	0.47		22	μF

**Notes:**

<sup>(1)</sup>Not applicable for V<sub>out(nom)</sub> > 4.5 V

<sup>(2)</sup>Turn-on time is time measured between the enable input just exceeding V<sub>EN</sub> high value and the output voltage just reaching 95 % of its nominal value

T<sub>J</sub> = 25 °C, V<sub>IN</sub> = V<sub>OUT(NOM)</sub> + 1 V, C<sub>IN</sub> = C<sub>OUT</sub> = 1 μF, I<sub>OUT</sub> = 1 mA, V<sub>EN</sub> = V<sub>IN</sub>, unless otherwise specified.

**Table 6: Electrical characteristics for LD39020AT, LD39020ADT**

Symbol	Parameter	Test conditions	Min.	Typ.	Max.	Unit
V <sub>IN</sub>	Operating input voltage		1.5		5.5	V
V <sub>OUT</sub>	V <sub>OUT</sub> accuracy	I <sub>OUT</sub> = 1 mA, T <sub>J</sub> = 25 °C	-0.5		0.5	%
		I <sub>OUT</sub> = 1 mA, -40 °C < T <sub>J</sub> < 125 °C	-1.5		1.5	%
ΔV <sub>OUT</sub>	Static line regulation <sup>(1)</sup>	V <sub>OUT(NOM)</sub> + 1 V ≤ V <sub>IN</sub> ≤ 5.5 V, I <sub>OUT</sub> = 10 mA		0.02		%/V
		-40 °C < T <sub>J</sub> < 125 °C			0.2	
ΔV <sub>OUT</sub>	Static load regulation	I <sub>OUT</sub> = 0 mA to 200 mA		10		mV
		-40 °C < T <sub>J</sub> < 125 °C			0.01	%/mA
V <sub>DROP</sub>	Dropout voltage	I <sub>OUT</sub> = 30 mA, V <sub>OUT</sub> = 2.8 V		35		mV
		I <sub>OUT</sub> = 200 mA, V <sub>OUT</sub> = 2.8 V -40 °C < T <sub>J</sub> < 125 °C		200	350	
e <sub>N</sub>	Output noise voltage	10 Hz to 100 kHz, I <sub>OUT</sub> = 10 mA		45		μV <sub>RMS</sub>
SVR	Supply voltage rejection	V <sub>IN</sub> = V <sub>OUT(NOM)</sub> + 1 V +/- V <sub>RIPPLE</sub> V <sub>RIPPLE</sub> = 0.2 V Freq. = 1 kHz I <sub>OUT</sub> = 30 mA		80		dB
		V <sub>IN</sub> = V <sub>OUT(NOM)</sub> + 1 V +/- V <sub>RIPPLE</sub> V <sub>RIPPLE</sub> = 0.2 V Freq. = 100 kHz I <sub>OUT</sub> = 30 mA		55		
I <sub>Q</sub>	Quiescent current	I <sub>OUT</sub> = 0 mA		20	40	μA
		I <sub>OUT</sub> = 200 mA		100		
I <sub>Standby</sub>	Standby current	V <sub>IN</sub> input current in OFF MODE: V <sub>EN</sub> = GND		0.03	1	μA
I <sub>SC</sub>	Short circuit current	R <sub>L</sub> = 0	250	350		mA
R <sub>ON</sub>	Output voltage discharge MOSFET	(only on LD39020ADT)		100		Ω
V <sub>EN</sub>	Enable input logic low	V <sub>IN</sub> = 1.5 V to 5.5 V -40 °C < T <sub>J</sub> < 125 °C			0.4	V
	Enable input logic high	V <sub>IN</sub> = 1.5 V to 5.5 V	1			



Symbol	Parameter	Test conditions	Min.	Typ.	Max.	Unit
		-40 °C < T <sub>J</sub> < 125 °C				
I <sub>EN</sub>	Enable pin input current	V <sub>EN</sub> = V <sub>IN</sub>			100	nA
TON <sup>(2)</sup>	Turn on time			100		µs
T <sub>SHDN</sub>	Thermal shutdown			160		°C
	Hysteresis			20		
C <sub>OUT</sub>	Output capacitor	Capacitance (see <a href="#">Figure 17: "Stability area vs (C<sub>OUT</sub>, ESR)"</a> )	0.47		22	µF

**Notes:**

<sup>(1)</sup>Not applicable for V<sub>out</sub>(nom) > 4.5 V

<sup>(2)</sup>Turn-on time is time measured between the enable input just exceeding V<sub>EN</sub> high value and the output voltage just reaching 95 % of its nominal value

## 6 Application information

### 6.1 Soft start function

The LD39020 has an internal soft start circuit. By increasing the startup time up to 100 $\mu$ s, without the need of any external soft start capacitor, this feature is able to keep the regulator inrush current at startup under control.

### 6.2 Output discharge function

The LD39020 integrates a MOSFET connected between Vout and GND. This transistor is activated when the EN pin goes to low logic level and has the function to quickly discharge the output capacitor when the device is disabled by the user.

The device is available with or without auto-discharge feature.

See [Table 8: "Order codes"](#) for more details.

### 6.3 Input and output capacitors

The LD39020 requires external capacitors to assure the regulator control loop stability.

Any good quality ceramic capacitor can be used but, the X5R and the X7R are suggested since they guarantee a very stable combination of capacitance and ESR overtemperature.

Locating the input/output capacitors as closer as possible to the relative pins is recommended.

The LD39020 requires an input capacitor with a minimum value of 1  $\mu$ F.

This capacitor must be located as closer as possible to the input pin of the device and returned to a clean analog ground.

The control loop of the LD39020 is designed to work with an output ceramic capacitor.

This capacitor must meet the requirements of minimum capacitance and equivalent series resistance (ESR), as shown in Fig17. To assure stability, the output capacitor must maintain its ESR and capacitance in the stable region, over the full operating temperature range.

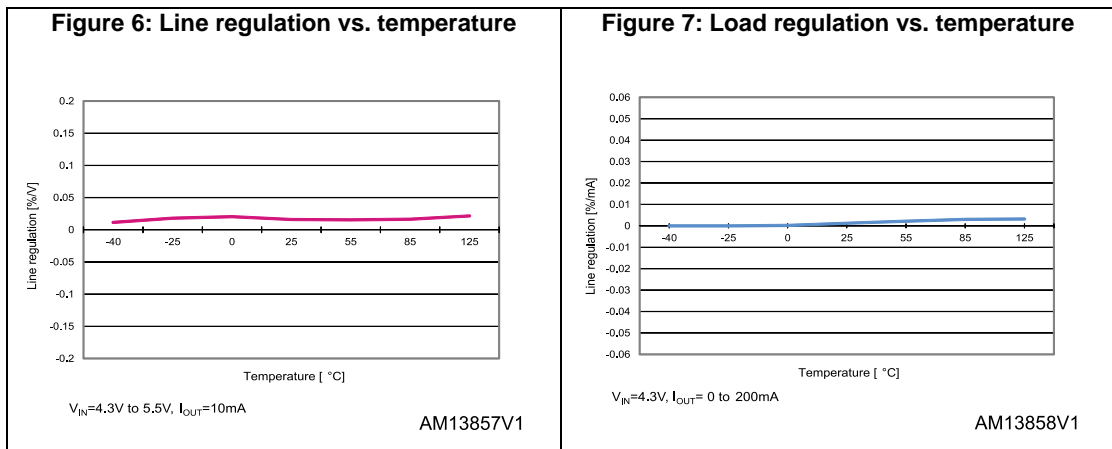
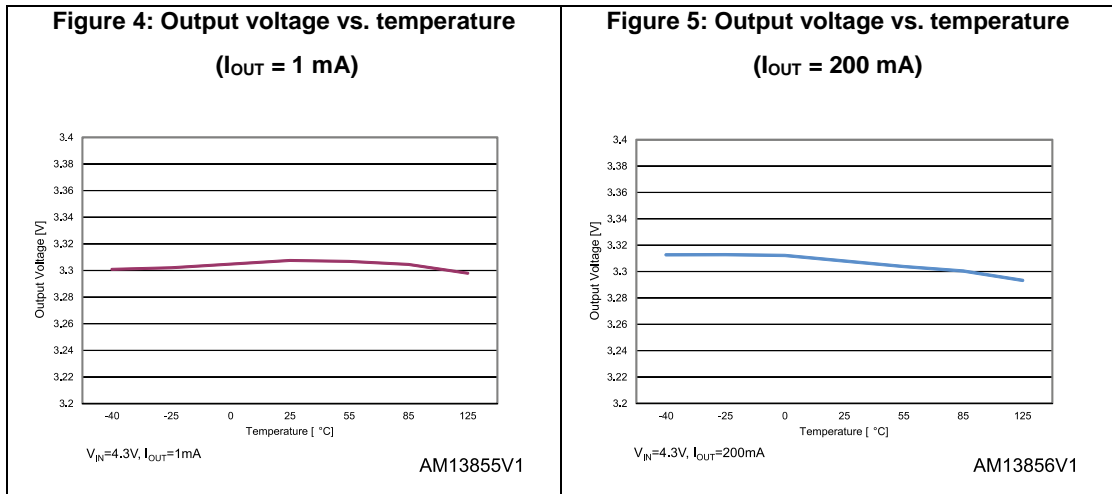
The LD39020 shows stability with a minimum effective output capacitance of 220 nF.

However, to keep stability in all operating conditions (temperature, input voltage and load variations), a minimum output capacitor of 0.47  $\mu$ F is recommended.

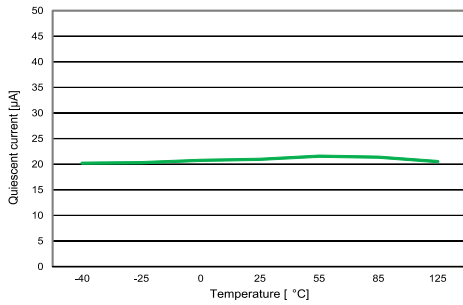
The suggested combination of 1  $\mu$ F input and output capacitors offers a good compromise among the stability of the regulator, optimum transient response and total PCB area occupation.

# 7 Typical characteristics

( $C_{IN} = C_{OUT} = 1 \mu F$ ,  $V_{EN}$  to  $V_{IN}$ ,  $T_J = 25^\circ C$  unless otherwise specified)



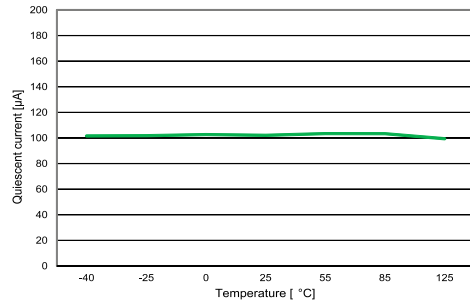
**Figure 8: Quiescent current vs. temperature**  
( $I_{OUT} = 0 \text{ mA}$ )



$V_{IN}=4.3V, I_{OUT}=0mA$

AM13859V1

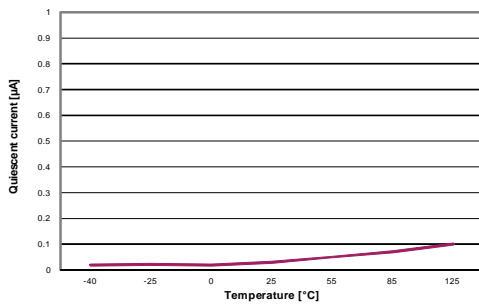
**Figure 9: Quiescent current vs. temperature**  
( $I_{OUT} = 200 \text{ mA}$ )



$V_{IN}=4.3V, I_{OUT}=200mA$

AM13860V1

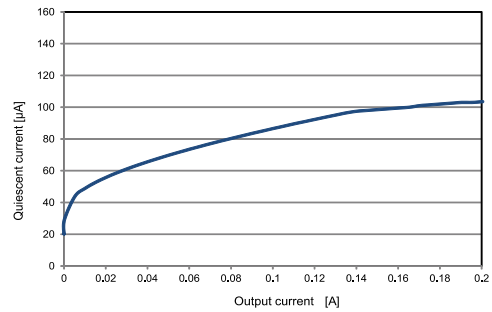
**Figure 10: Shutdown current vs. temperature**



$V_{IN}=4.3V, V_{EN}=GND$

AM13861V1

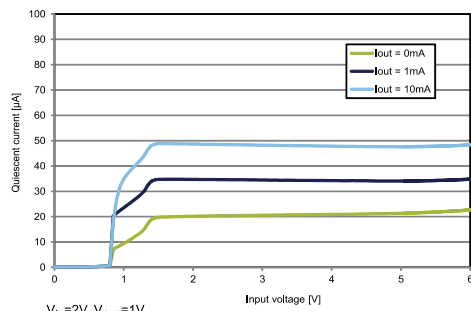
**Figure 11: Quiescent current vs. load current**



$V_{IN}=2V, V_{OUT}=1V$

AM13862V1

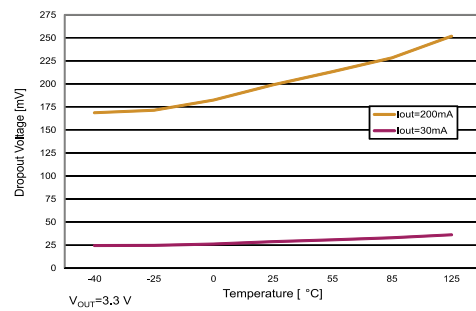
**Figure 12: Quiescent current vs. input voltage**



$V_{IN}=2V, V_{OUT}=1V$

AM13863V1

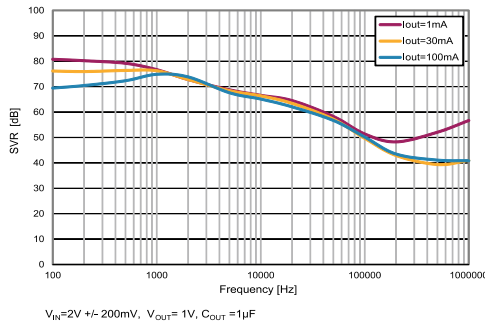
**Figure 13: Dropout voltage vs. temperature**



$V_{OUT}=3.3V$

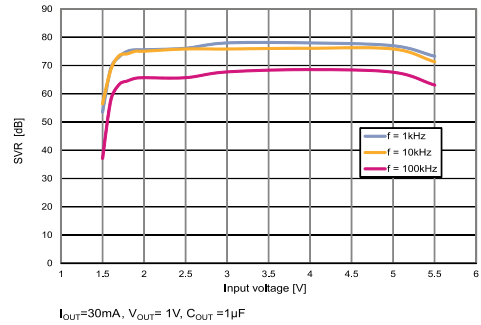
AM13864V1

Figure 14: Supply voltage rejection vs. frequency



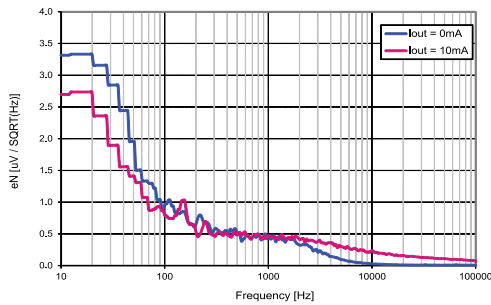
AM13865V1

Figure 15: Supply voltage rejection vs. input voltage



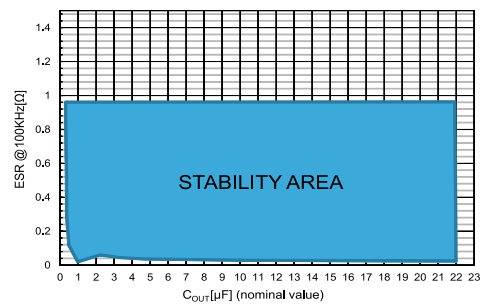
AM13866V1

Figure 16: Output noise spectral density



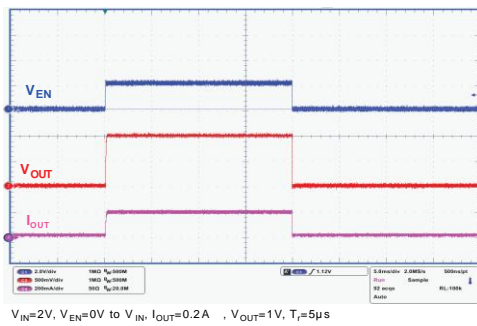
AM13867V1

Figure 17: Stability area vs (COUT, ESR)



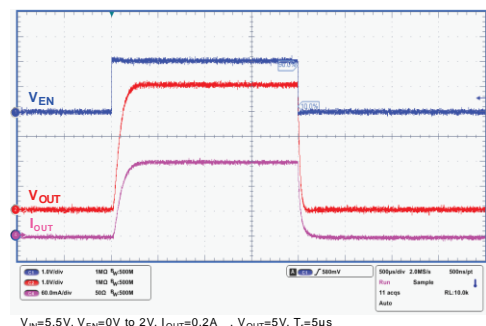
AM13868V1

Figure 18: Enable startup ( $V_{OUT} = 1 V$ )



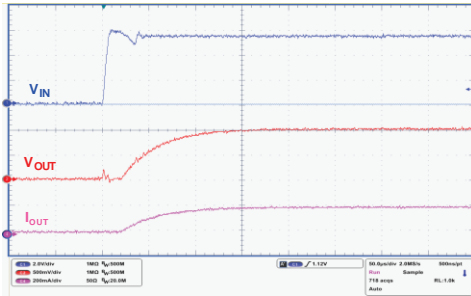
AM13869V1

Figure 19: Enable startup ( $V_{OUT} = 5 V$ )



AM13870V1

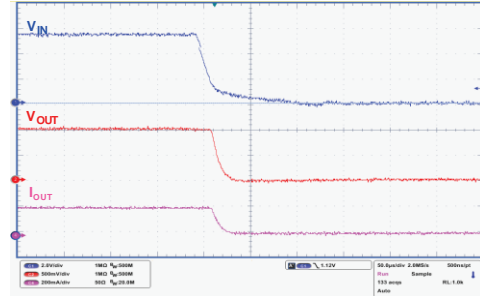
Figure 20: Turn-on time ( $V_{OUT} = 1\text{ V}$ )



$V_{IN}=V_{EN}$  from 0V to 5.5V,  $I_{OUT}=0.2\text{ A}$ ,  $V_{OUT}=1\text{ V}$ ,  $T_r=5\mu\text{ s}$

AM13871V1

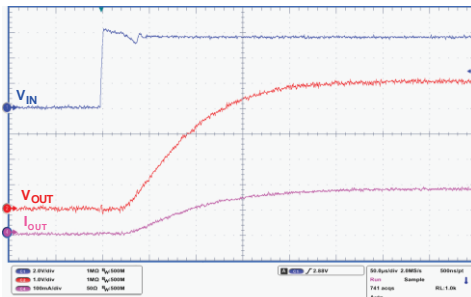
Figure 21: Turn-off time ( $V_{OUT} = 1\text{ V}$ )



$V_{IN}=V_{EN}$  from 5.5V to 0V,  $I_{OUT}=0.2\text{ A}$ ,  $V_{OUT}=1\text{ V}$ ,  $T_f=5\mu\text{ s}$

AM13872V1

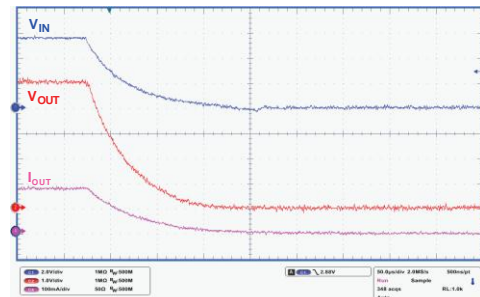
Figure 22: Turn-on time ( $V_{OUT} = 5\text{ V}$ )



$V_{IN}=V_{EN}$  from 0V to 5.5V,  $I_{OUT}=0.2\text{ A}$ ,  $V_{OUT}=5\text{ V}$ ,  $T_r=5\mu\text{ s}$

AM13873V1

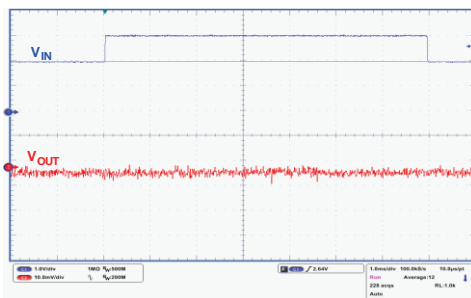
Figure 23: Turn-off time ( $V_{OUT} = 5\text{ V}$ )



$V_{IN}=V_{EN}$  from 5.5V to 0V,  $I_{OUT}=0.2\text{ A}$ ,  $V_{OUT}=5\text{ V}$ ,  $T_f=5\mu\text{ s}$

AM13874V1

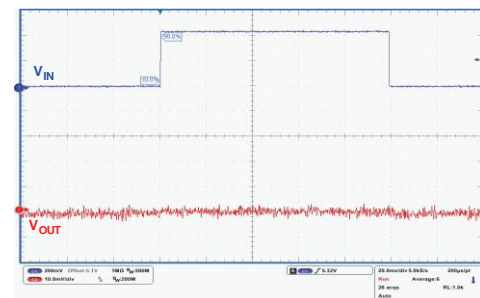
Figure 24: Line transient ( $V_{OUT} = 1\text{ V}$ )



$V_{IN}=V_{EN}$  from 2V to 3V,  $I_{OUT}=10\text{ mA}$ ,  $V_{OUT}=1\text{ V}$ ,  $T_r=T_f=5\mu\text{ s}$

AM13875V1

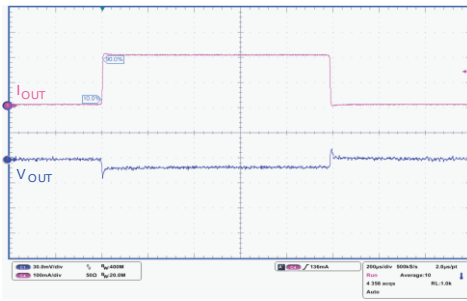
Figure 25: Line transient ( $V_{OUT} = 5\text{ V}$ )



$V_{IN}=V_{EN}$  from 5.1V to 5.5V,  $I_{OUT}=10\text{ mA}$ ,  $V_{OUT}=5\text{ V}$ ,  $T_r=T_f=5\mu\text{ s}$

AM13876V1

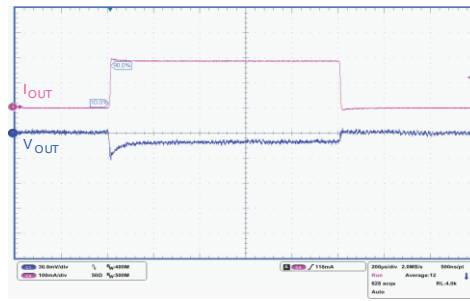
Figure 26: Load transient ( $V_{OUT} = 1\text{ V}$ )



$V_{IN}=V_{EN}=2\text{V}$ ,  $I_{OUT}$ =from 0 to 0.2A ,  $V_{OUT}= 1\text{V}$ ,  $t_r=t_f=5\mu\text{s}$

AM13877V1

Figure 27: Load transient ( $V_{OUT} = 5\text{ V}$ )



$V_{IN}=V_{EN}=5.5\text{V}$ ,  $I_{OUT}$ =from 0 to 0.2A ,  $V_{OUT}= 5\text{V}$ ,  $t_r=t_f=5\mu\text{s}$

AM13878V1

## 8 Package mechanical data

In order to meet environmental requirements, ST offers these devices in different grades of ECOPACK® packages, depending on their level of environmental compliance.

ECOPACK® specifications, grade definitions and product status are available at: [www.st.com](http://www.st.com). ECOPACK® is an ST trademark.

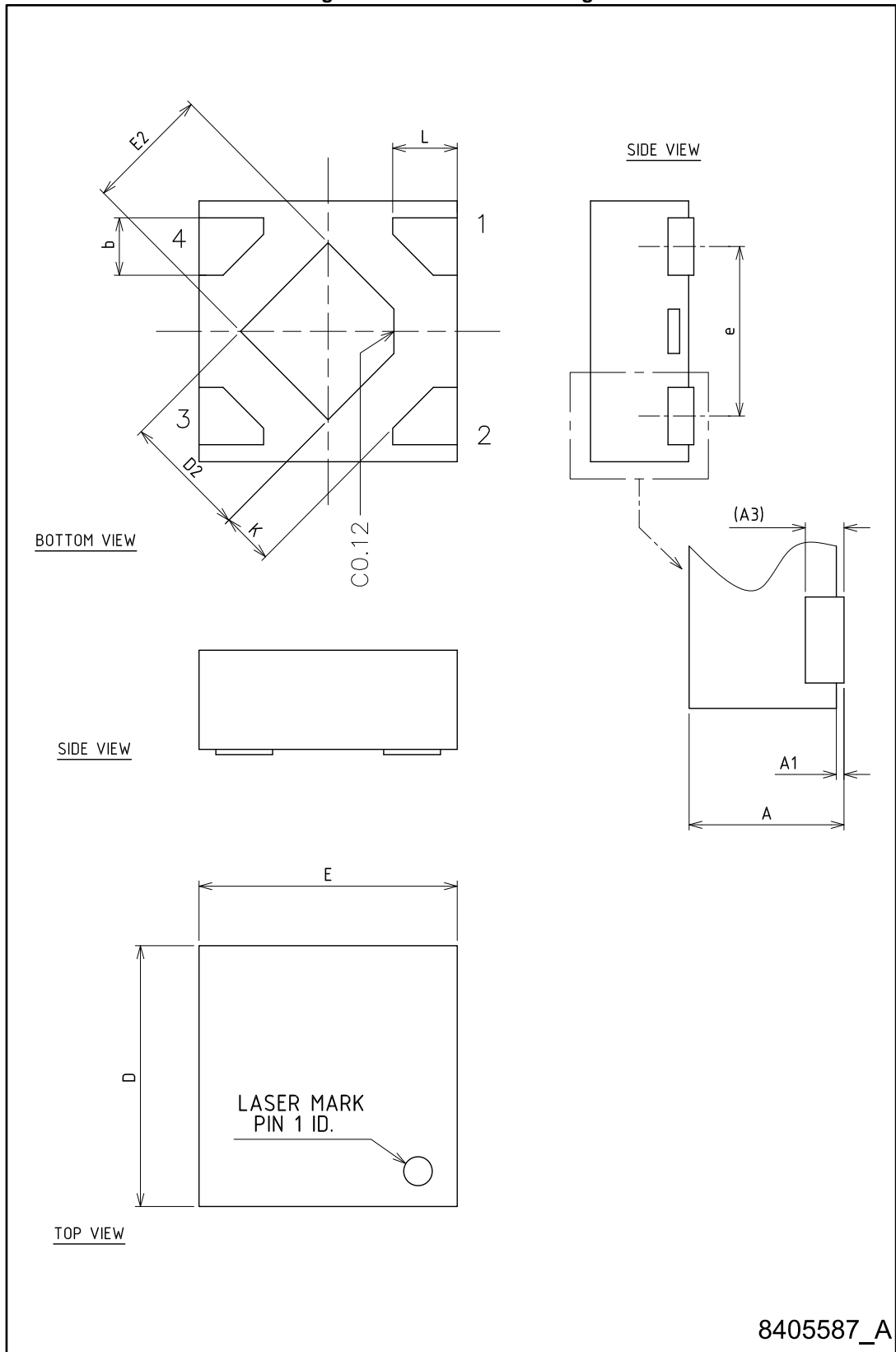
### 8.1 DFN4 1x1 package info

Table 7: DFN 1x1-4L mechanical data

Dim.	mm.		
	Min.	Typ.	Max.
A	0.34	0.37	0.40
A1	0	0.02	0.05
A3		0.10	
b	0.17	0.22	0.27
D	0.95	1.00	1.05
D2	0.43	0.48	0.53
E	0.95	1.00	1.05
E2	0.43	0.48	0.53
e		0.65	
L	0.20	0.25	0.30
K	0.15		

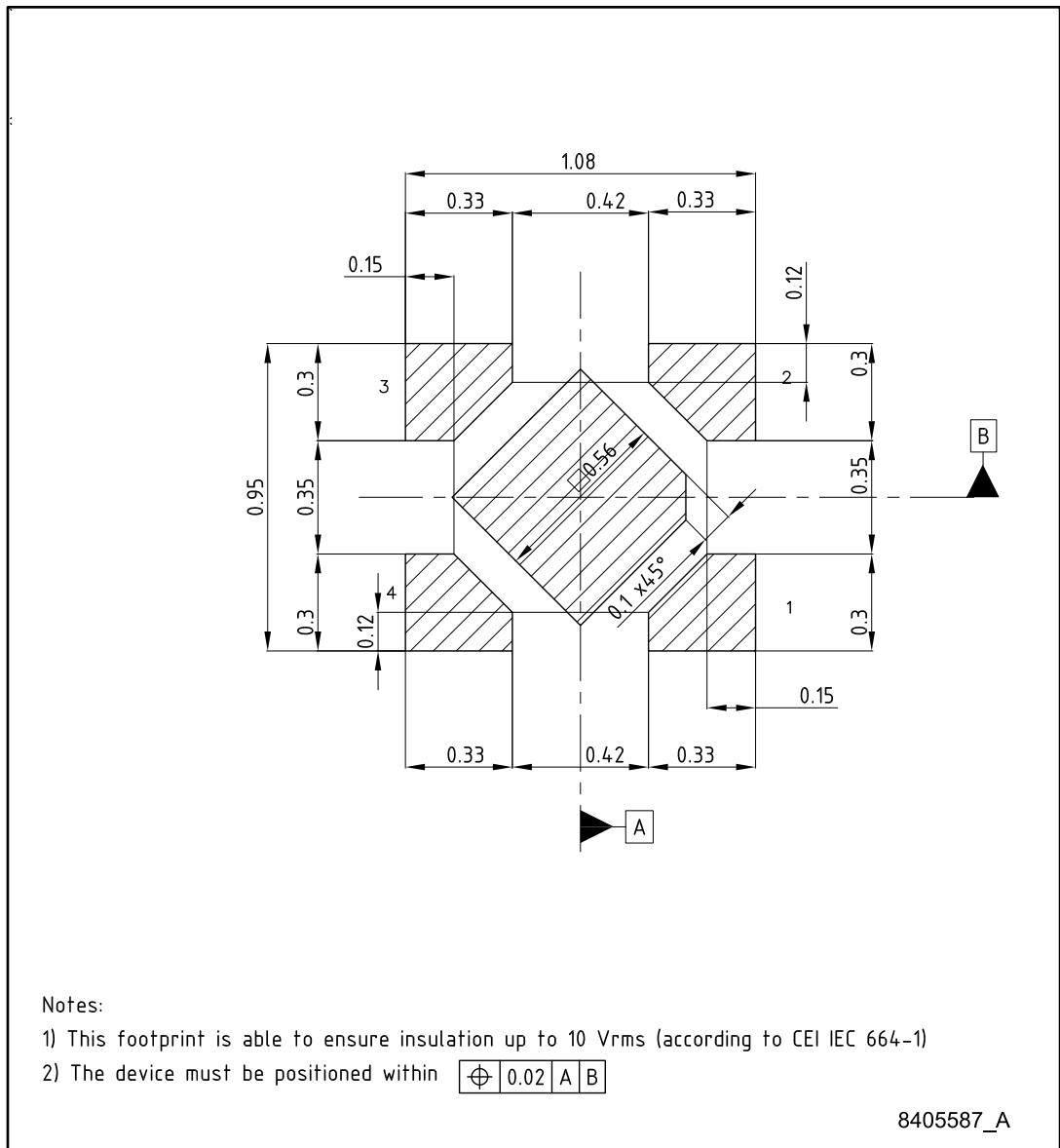


Figure 28: DFN 1x1-4L drawing



8405587\_A

Figure 29: DFN 1x1-4L footprint



## 9 Order codes

Table 8: Order codes

Order code	Output voltage (V)	Auto-discharge	Tolerance (%)	Marking
LD39020ADTPU08R <sup>(1)</sup>	0.8	Yes	0.5	A1
LD39020DTPU08R			2	08
LD39020ATPU08R <sup>(1)</sup>		No	0.5	B1
LD39020TPU08R <sup>(1)</sup>			2	C1
LD39020ADTPU095R <sup>(1)</sup>	0.95	Yes	0.5	A2
LD39020DTPU095R			2	95
LD39020ATPU095R <sup>(1)</sup>		No	0.5	B2
LD39020TPU095R <sup>(1)</sup>			2	C2
LD39020ADTPU10R <sup>(1)</sup>	1	Yes	0.5	A3
LD39020DTPU10R			2	10
LD39020ATPU10R <sup>(1)</sup>		No	0.5	B3
LD39020TPU10R <sup>(1)</sup>			2	C3
LD39020ADTPU11R <sup>(1)</sup>	1.1	Yes	0.5	A4
LD39020DTPU11R			2	11
LD39020ATPU11R <sup>(1)</sup>		No	0.5	B4
LD39020TPU11R <sup>(1)</sup>			2	C4
LD39020ADTPU12R <sup>(1)</sup>	1.2	Yes	0.5	A5
LD39020DTPU12R			2	12
LD39020ATPU12R <sup>(1)</sup>		No	0.5	B5
LD39020TPU12R <sup>(1)</sup>			2	C5
LD39020ADTPU15R <sup>(1)</sup>	1.5	Yes	0.5	A6
LD39020DTPU15R			2	15
LD39020ATPU15R <sup>(1)</sup>		No	0.5	B6
LD39020TPU15R <sup>(1)</sup>			2	C6
LD39020ADTPU18R <sup>(1)</sup>	1.8	Yes	0.5	A7
LD39020DTPU18R			2	18
LD39020ATPU18R <sup>(1)</sup>		No	0.5	B7
LD39020TPU18R <sup>(1)</sup>			2	C7
LD39020ADTPU20R <sup>(1)</sup>	2	Yes	0.5	A8
LD39020DTPU20R			2	20
LD39020ATPU20R <sup>(1)</sup>		No	0.5	B8

Order code	Output voltage (V)	Auto-discharge	Tolerance (%)	Marking
LD39020TPU20R <sup>(1)</sup>			2	C8
LD39020ADTPU21R <sup>(1)</sup>	2.1	Yes	0.5	A9
LD39020DTPU21R			2	21
LD39020ATPU21R <sup>(1)</sup>		No	0.5	B9
LD39020TPU21R <sup>(1)</sup>			2	C9
LD39020ADTPU25R <sup>(1)</sup>	2.5	Yes	0.5	AA
LD39020DTPU25R			2	25
LD39020ATPU25R <sup>(1)</sup>		No	0.5	BA
LD39020TPU25R <sup>(1)</sup>			2	CA
LD39020ADTPU27R <sup>(1)</sup>	2.7	Yes	0.5	AB
LD39020DTPU27R			2	27
LD39020ATPU27R <sup>(1)</sup>		No	0.5	BB
LD39020TPU27R <sup>(1)</sup>			2	CB
LD39020ADTPU28R <sup>(1)</sup>	2.8	Yes	0.5	AC
LD39020DTPU28R			2	28
LD39020ATPU28R <sup>(1)</sup>		No	0.5	BC
LD39020TPU28R <sup>(1)</sup>			2	CC
LD39020ADTPU285R <sup>(1)</sup>	2.85	Yes	0.5	AD
LD39020DTPU285R			2	85
LD39020ATPU285R <sup>(1)</sup>		No	0.5	BD
LD39020TPU285R <sup>(1)</sup>			2	CD
LD39020ADTPU29R <sup>(1)</sup>	2.9	Yes	0.5	AE
LD39020DTPU29R			2	29
LD39020ATPU29R <sup>(1)</sup>		No	0.5	BE
LD39020TPU29R <sup>(1)</sup>			2	CE
LD39020ADTPU30R <sup>(1)</sup>	3	Yes	0.5	AF
LD39020DTPU30R			2	30
LD39020ATPU30R <sup>(1)</sup>		No	0.5	BF
LD39020TPU30R <sup>(1)</sup>			2	CF
LD39020ADTPU31R <sup>(1)</sup>	3.1	Yes	0.5	AG
LD39020DTPU31R			2	31
LD39020ATPU31R <sup>(1)</sup>		No	0.5	BG
LD39020TPU31R <sup>(1)</sup>			2	CG
LD39020ADTPU32R <sup>(1)</sup>	3.2	Yes	0.5	AH
LD39020DTPU32R <sup>(1)</sup>			2	32
LD39020ATPU32R <sup>(1)</sup>		No	0.5	BH

Order code	Output voltage (V)	Auto-discharge	Tolerance (%)	Marking
LD39020TPU32R <sup>(1)</sup>			2	CH
LD39020ADTPU33R <sup>(1)</sup>	3.3	Yes	0.5	AJ
LD39020DTPU33R			2	33
LD39020ATPU33R <sup>(1)</sup>		No	0.5	BJ
LD39020TPU33R <sup>(1)</sup>			2	CJ
LD39020ADTPU36R <sup>(1)</sup>	3.6	Yes	0.5	AK
LD39020DTPU36R			2	36
LD39020ATPU36R <sup>(1)</sup>		No	0.5	BK
LD39020TPU36R <sup>(1)</sup>			2	CK
LD39020ADTPU40R <sup>(1)</sup>	4	Yes	0.5	AL
LD39020DTPU40R			2	40
LD39020ATPU40R <sup>(1)</sup>		No	0.5	BL
LD39020TPU40R <sup>(1)</sup>			2	CL
LD39020ADTPU47R <sup>(1)</sup>	4.7	Yes	0.5	AM
LD39020DTPU47R			2	47
LD39020ATPU47R <sup>(1)</sup>		No	0.5	BM
LD39020TPU47R <sup>(1)</sup>			2	CM
LD39020ADTPU50R <sup>(1)</sup>	5	Yes	0.5	AN
LD39020DTPU50R			2	50
LD39020ATPU50R <sup>(1)</sup>		No	0.5	BN
LD39020TPU50R <sup>(1)</sup>			2	CN

**Notes:**<sup>(1)</sup>Available on request.

## 10 Revision history

Table 9: Document revision history

Date	Revision	Changes
04-Dec-2013	1	Initial release.

**Please Read Carefully**

Information in this document is provided solely in connection with ST products. STMicroelectronics NV and its subsidiaries ("ST") reserve the right to make changes, corrections, modifications or improvements, to this document, and the products and services described herein at any time, without notice.

All ST products are sold pursuant to ST's terms and conditions of sale.

Purchasers are solely responsible for the choice, selection and use of the ST products and services described herein, and ST assumes no liability whatsoever relating to the choice, selection or use of the ST products and services described herein.

No license, express or implied, by estoppel or otherwise, to any intellectual property rights is granted under this document. If any part of this document refers to any third party products or services it shall not be deemed a license grant by ST for the use of such third party products or services, or any intellectual property contained therein or considered as a warranty covering the use in any manner whatsoever of such third party products or services or any intellectual property contained therein.

**UNLESS OTHERWISE SET FORTH IN ST'S TERMS AND CONDITIONS OF SALE ST DISCLAIMS ANY EXPRESS OR IMPLIED WARRANTY WITH RESPECT TO THE USE AND/OR SALE OF ST PRODUCTS INCLUDING WITHOUT LIMITATION IMPLIED WARRANTIES OF MERCHANTABILITY, FITNESS FOR A PARTICULAR PURPOSE (AND THEIR EQUIVALENTS UNDER THE LAWS OF ANY JURISDICTION), OR INFRINGEMENT OF ANY PATENT, COPYRIGHT OR OTHER INTELLECTUAL PROPERTY RIGHT.**

**ST PRODUCTS ARE NOT DESIGNED OR AUTHORIZED FOR USE IN: (A) SAFETY CRITICAL APPLICATIONS SUCH AS LIFE SUPPORTING, ACTIVE IMPLANTED DEVICES OR SYSTEMS WITH PRODUCT FUNCTIONAL SAFETY REQUIREMENTS; (B) AERONAUTIC APPLICATIONS; (C) AUTOMOTIVE APPLICATIONS OR ENVIRONMENTS, AND/OR (D) AEROSPACE APPLICATIONS OR ENVIRONMENTS. WHERE ST PRODUCTS ARE NOT DESIGNED FOR SUCH USE, THE PURCHASER SHALL USE PRODUCTS AT PURCHASER'S SOLE RISK, EVEN IF ST HAS BEEN INFORMED IN WRITING OF SUCH USAGE, UNLESS A PRODUCT IS EXPRESSLY DESIGNATED BY ST AS BEING INTENDED FOR "AUTOMOTIVE, AUTOMOTIVE SAFETY OR MEDICAL" INDUSTRY DOMAINS ACCORDING TO ST PRODUCT DESIGN SPECIFICATIONS. PRODUCTS FORMALLY ESCC, QML OR JAN QUALIFIED ARE DEEMED SUITABLE FOR USE IN AEROSPACE BY THE CORRESPONDING GOVERNMENTAL AGENCY.**

Resale of ST products with provisions different from the statements and/or technical features set forth in this document shall immediately void any warranty granted by ST for the ST product or service described herein and shall not create or extend in any manner whatsoever, any liability of ST.

ST and the ST logo are trademarks or registered trademarks of ST in various countries.

Information in this document supersedes and replaces all information previously supplied.

The ST logo is a registered trademark of STMicroelectronics. All other names are the property of their respective owners.

© 2013 STMicroelectronics - All rights reserved

STMicroelectronics group of companies

Australia - Belgium - Brazil - Canada - China - Czech Republic - Finland - France - Germany - Hong Kong - India - Israel - Italy  
- Japan - Malaysia - Malta - Morocco - Philippines - Singapore - Spain - Sweden - Switzerland - United Kingdom - United  
States of America

[www.st.com](http://www.st.com)