

HF/VHF/UHF RF power N-channel MOSFETs

Features

- Excellent thermal stability
- Common source configuration
- $P_{OUT} = 350\text{ W}$ min. with 29 dB gain @ 30 MHz
- In compliance with the 2002/95/EEC European directive

Description

The SD3933 is an N-channel MOS field-effect RF power transistor. It is intended for use in 100 V DC large signal applications up to 200 MHz.

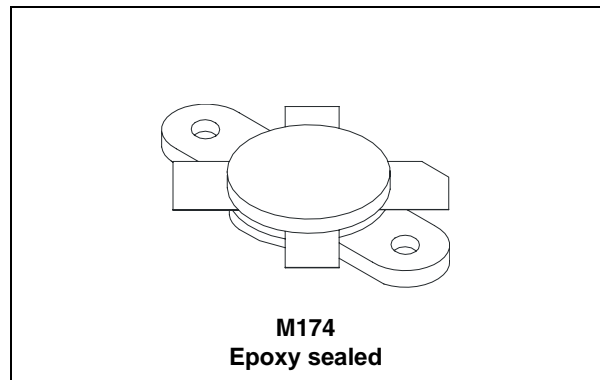

Figure 1. Pin connection

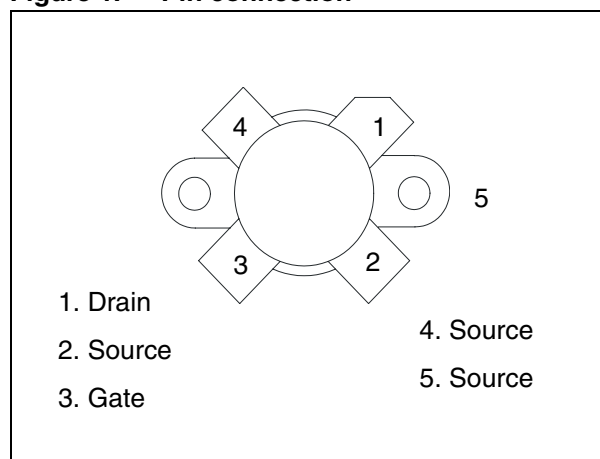

Table 1. Device summary

Part number	Marking	Package	Packaging
SD3933	SD3933 ⁽¹⁾	M177	Plastic tray

1. For more details please refer to [Chapter 9: Marking, packing and shipping specifications](#)

Contents

1	Electrical data	3
1.1	Maximum ratings	3
1.2	Thermal data	3
2	Electrical characteristics	4
2.1	Static	4
2.2	Dynamic	4
3	Impedance data	5
4	Typical performance	6
5	Test circuit	10
6	Circuit layout	13
7	VGS/GFS sorts	14
8	Package mechanical data	17
9	Marking, packing and shipping specifications	18
10	Revision history	19

1 Electrical data

1.1 Maximum ratings

($T_{CASE} = 25\text{ °C}$)

Table 2. Absolute maximum ratings

Symbol	Parameter	Value	Unit
$V_{(BR)DSS}^{(1)}$	Drain source voltage	250	V
V_{DGR}	Drain-gate voltage ($R_{GS} = 1\text{ M}\Omega$)	250	V
V_{GS}	Gate-source voltage	± 20	V
I_D	Drain current	20	A
P_{DISS}	Power dissipation	648	W
E_{AS}	Avalanche energy Single pulse ($I_D = 50\text{ A} - 800\text{ }\mu\text{H}$ coil)	1000	mJ
T_J	Max. operating junction temperature	200	$^{\circ}\text{C}$
T_{STG}	Storage temperature	-65 to +150	$^{\circ}\text{C}$

1. $T_J = 150\text{ }^{\circ}\text{C}$

1.2 Thermal data

Table 3. Thermal data

Symbol	Parameter	Value	Unit
R_{thJC}	Junction - case thermal resistance	0.27	$^{\circ}\text{C}/\text{W}$

2 Electrical characteristics

$T_{CASE} = +25\text{ }^{\circ}\text{C}$

2.1 Static

Table 4. Static

Symbol	Test conditions		Min	Typ	Max	Unit
$V_{(BR)DSS}^{(1)}$	$V_{GS} = 0\text{ V}$	$I_{DS} = 100\text{ mA}$	250			V
I_{DSS}	$V_{GS} = 0\text{ V}$	$V_{DS} = 100\text{ V}$			2	mA
I_{GSS}	$V_{GS} = 20\text{ V}$	$V_{DS} = 0\text{ V}$			500	nA
$V_{GS(Q)}$	$V_{DS} = 10\text{ V}$	$I_D = 250\text{ mA}$	1.5	2.5	4.0	V
$V_{DS(ON)}$	$V_{GS} = 10\text{ V}$	$I_D = 10\text{ A}$		2.5	3.5	V
G_{FS}	$V_{DS} = 10\text{ V}$	$I_D = 5\text{ A}$	5	8		S
C_{ISS}	$V_{GS} = 0\text{ V}$	$V_{DS} = 100\text{ V}$		1000		pF
C_{OSS}	$V_{GS} = 0\text{ V}$	$V_{DS} = 100\text{ V}$		265		pF
C_{RSS}	$V_{GS} = 0\text{ V}$	$V_{DS} = 100\text{ V}$		13		pF

1. $T_J = +150\text{ }^{\circ}\text{C}$

2.2 Dynamic

Table 5. Dynamic

Symbol	Test conditions		Min	Typ	Max	Unit
P_{OUT}	$V_{DD} = 100\text{ V}$	$I_{DQ} = 250\text{ mA}$ $f = 30\text{ MHz}$	350			W
G_{PS}	$V_{DD} = 100\text{ V}$	$I_{DQ} = 250\text{ mA}$ $P_{OUT} = 350\text{ W}$ $f = 30\text{ MHz}$	25	29		dB
h_D	$V_{DD} = 100\text{ V}$	$I_{DQ} = 250\text{ mA}$ $P_{OUT} = 350\text{ W}$ $f = 30\text{ MHz}$	60	66		%
Load mismatch	$V_{DD} = 100\text{ V}$	$I_{DQ} = 250\text{ mA}$ $P_{OUT} = 300\text{ W}$ $f = 30\text{ MHz}$ All phase angles	3:1			VSWR

3 Impedance data

Figure 2. Impedance data

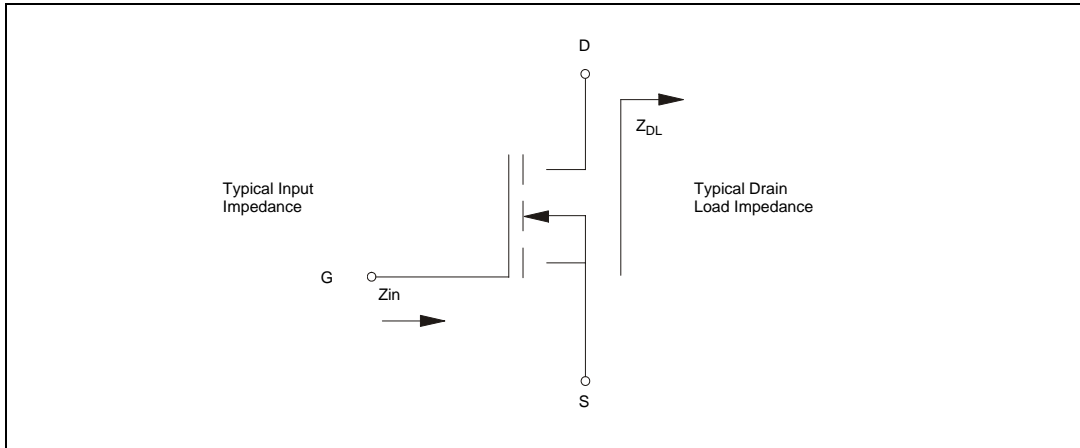

Table 6. Impedance data (350 W load line)

Frequency	$Z_{IN} (\Omega)$	$Z_{DL} (\Omega)$
10 MHz	6.56 - j9.75	12.17 + j2.76
20 MHz	2.80 - j5.78	10.6 + j4.81
30 MHz	1.96 - j3.90	8.73 + j5.94
40 MHz	1.69 - j2.89	7.00 + j6.35
50 MHz	1.59 - j2.30	5.58 + j6.32
60 MHz	1.55 - j1.93	4.47 + j6.06
70 MHz	1.55 - j1.71	3.62 + j5.72
80 MHz	1.54 - j1.58	2.97 + j5.35
90 MHz	1.53 - j1.50	2.46 + j4.99
100 MHz	1.52 - j1.45	2.07 + j4.65

4 Typical performance

Figure 3. Capacitance vs. supply voltage

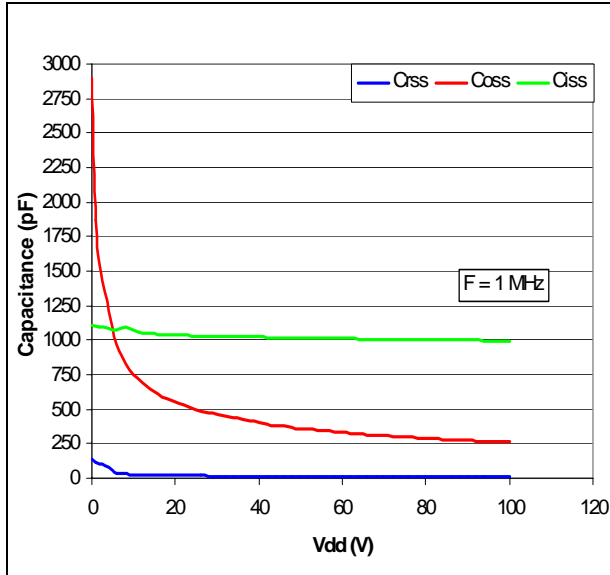

Figure 4. Drain current vs. gate source voltage

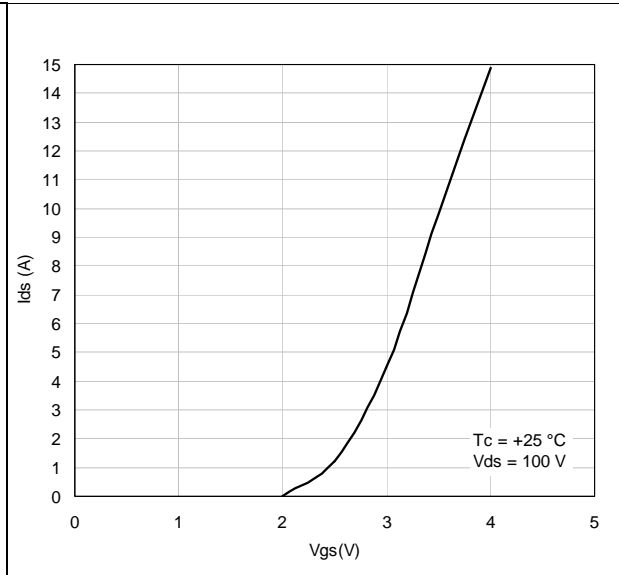

Figure 5. Drain current vs. drain source voltage

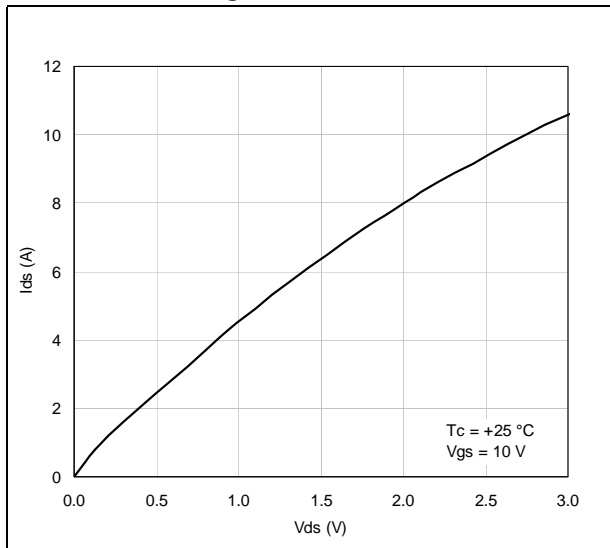

Figure 6. Gate source voltage vs. case temperature

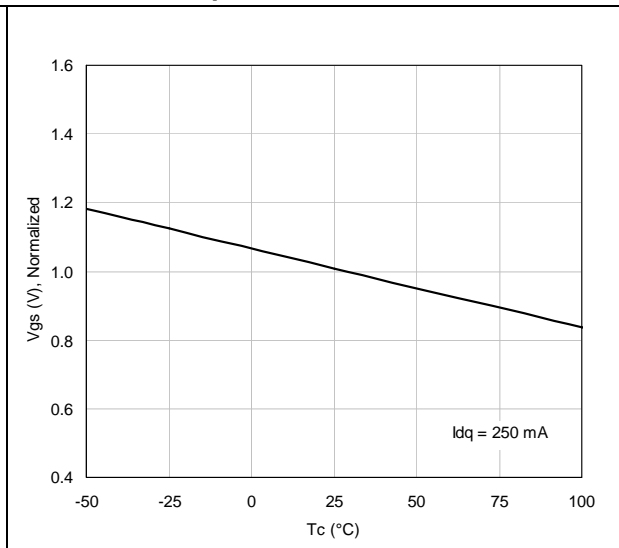

Figure 7. Output power vs. input power

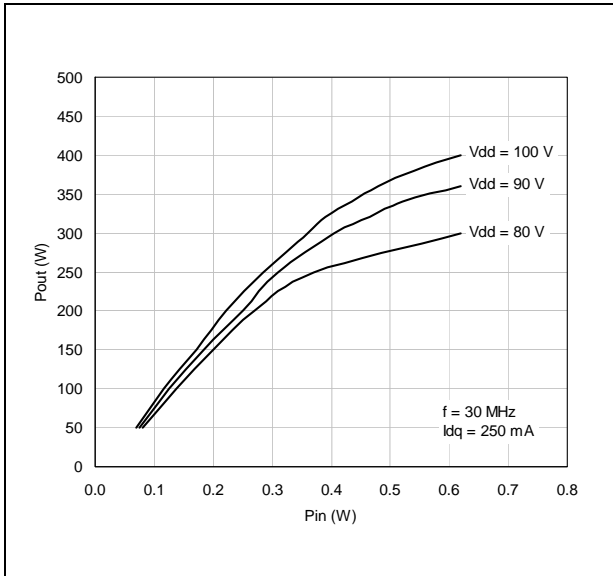

Figure 8. Output power vs. input power

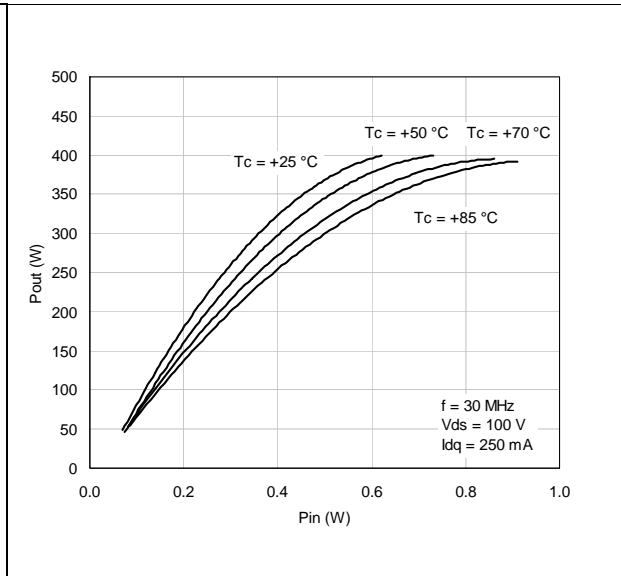

Figure 9. Power gain vs. output power

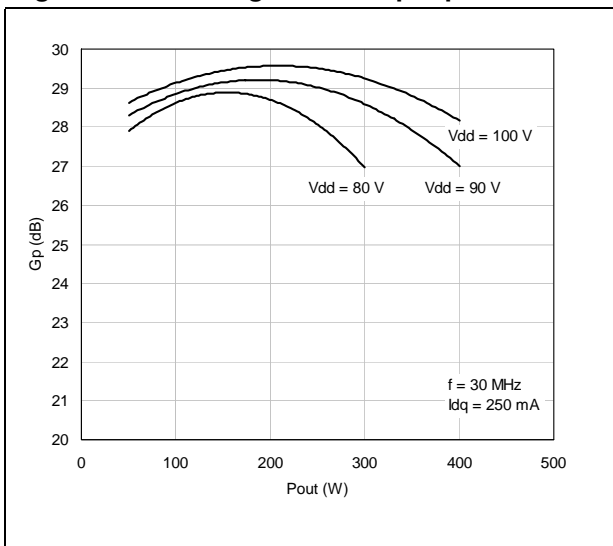

Figure 10. Power gain vs. output power

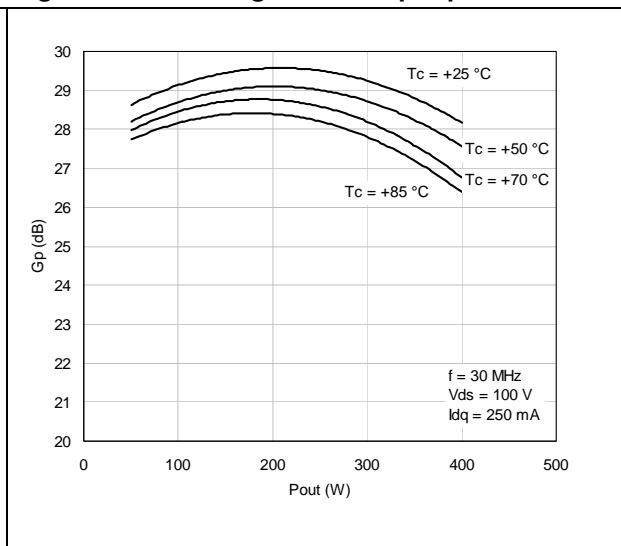

Figure 11. Efficiency vs. output power

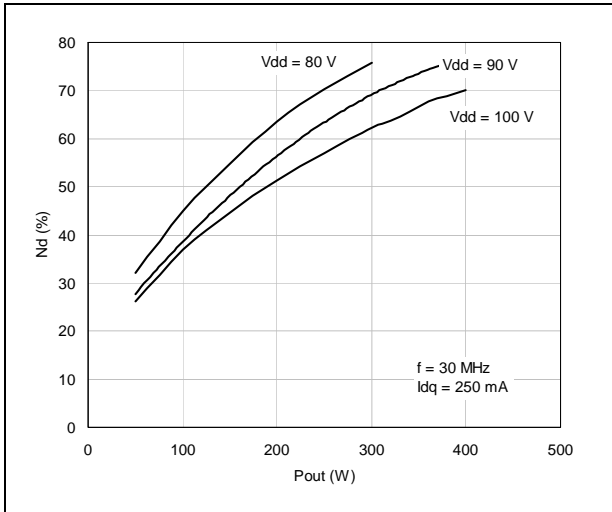

Figure 12. Efficiency vs. output power

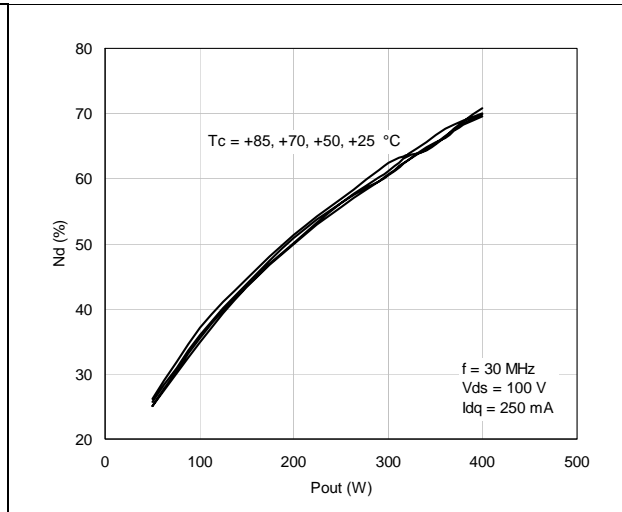

Figure 13. Input return loss vs. output power

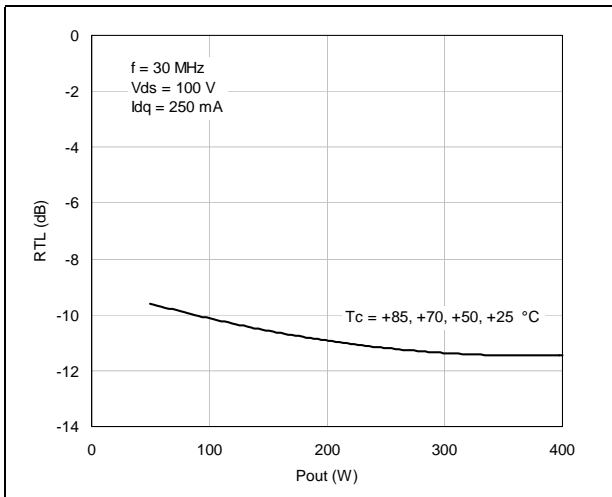

Figure 14. Output power vs. supply voltage

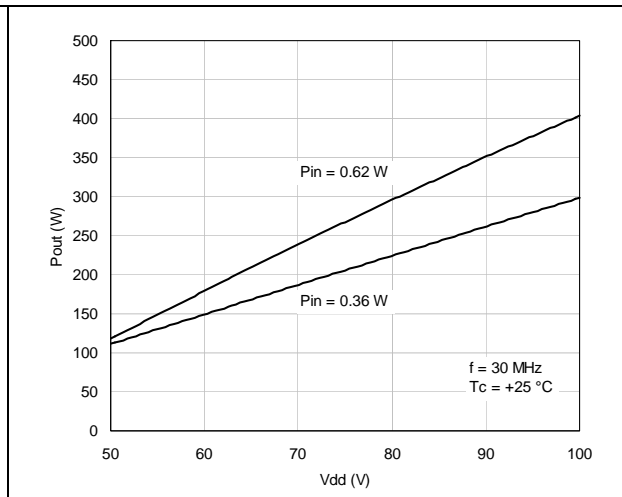
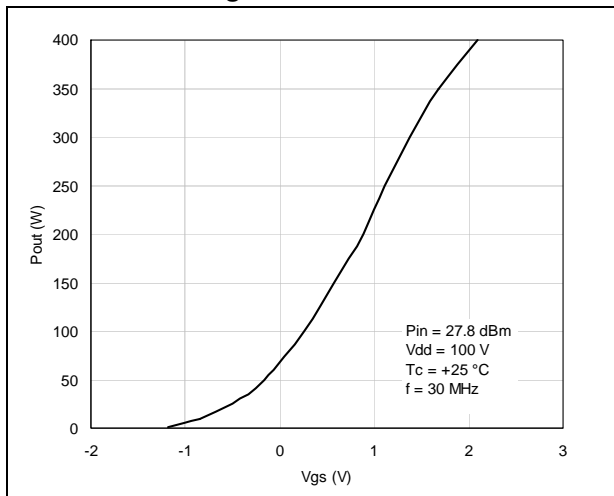

Figure 15. Output power vs. gate source voltage



5 Test circuit

Figure 16. Test circuit

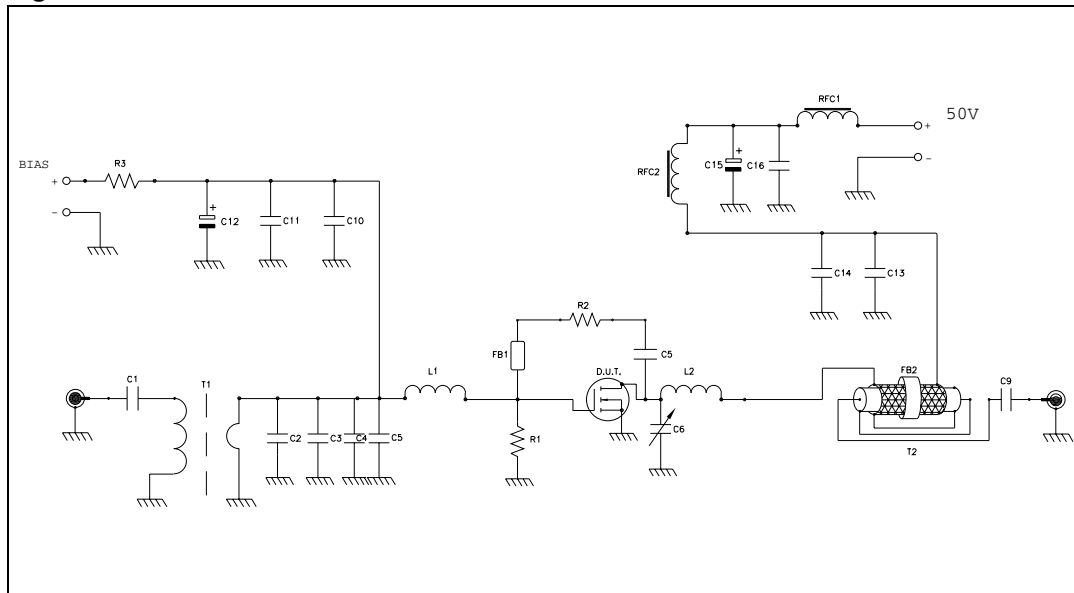

Table 7. Components list

Item	Qty	Part N°	Vendor	Description
C2	1	ATC700B751MW50X	ATC	750 pF ATC 700B surface mount ceramic chip capacitor
C1	1		Vishay	0.1 μF / 500V surface mount ceramic chip capacitor
R3	1		VENKEL	7.5 kΩ 1 W surface mount chip resistor
R1	1			7.5 kΩ 1/2 W axial lead resistor
T2	1	83242	BELDEN	Transformer, RG-142B/U 50 Ω coaxial cable OD = 0.165[4.18] L = 15"[381.00]
	1	TYPE 2170	ALPHA	Covered with 15"[381.00] tinned copper tubular braid 13/65"[5.1] width
T1	1	RT-600-9	COMM CONCEPTS, INC	Transformer, HF 2-30 MHz surface mount 9:1 (impedance ratio) (43 material)
L2	1	TYPE 8011	BELDEN	inductor, 1 3/4 turn air-wound #12AWG ID = 0.250 [6.34] bus bar wire
L1	1	TYPE 8074	BELDEN	Inductor, 1 3/4 turn air-wound #16AWG ID = 0.225 Poly-coated Magnet Wire
RFC2	1	2643801102	FAIR-RITE CORP	3 turns AWG #14 wire through ferrite toroid
RFC1	1	2643801102	FAIR-RITE CORP	3 turns AWG #14 wire through ferrite toroid
FB2	2	5967002701	FAIR-RITE CORP	Toroid
18	AR	TTS-S06	SPC TECHNOLOGY	Clear teflon shrink tubing

Table 7. Components list (continued)

Item	Qty	Part N°	Vendor	Description
17	AR	TYPE 8011	BELDEN	Wire, bus bar AWG #12 solid tinned copper
16	1	108-0910-001	EF JOHNSON	Nylon insulated banana jack, blue
15	1	108-0902-001	EF JOHNSON	Nylon insulated banana jack, red
14	1	108-0903-001	EF JOHNSON	Nylon insulated banana jack, black
13	2			Wear block, 0.010 [0.25] X 0.25 [6,35] X 0.300 [7,62] LG copper
12	1			Device under test
11	95	545562-7	MARK EYELETS INC	Eyelet, standard flat flange copper, electrotin
10	2	92196A108	McMASTER-CARR	Screw, hex socket set, 4-40 X 3/8 [9.53] LG
9	8	91252A251	McMASTER-CARR	Screw, socket head, cap SS, 10-32 X 1 1/2 [38.10] LG
8	3	92196A146	McMASTER-CARR	Screw, socket head cap, SS 6-32 X 3/8 [9.53] LG
7	4	WLS-04-017-SZ	SPC TECHNOLOGY	Washer, #4 split lock
6	4	92196A108	McMASTER-CARR	Screw, socket head cap, SS 4-40 X 3/8 [9.53] LG
5	2	5050-0037	APPLIED SPECIALTIES	Connector, AC-N
4				Power panel and heat sink (see sht 6)
3				Core (see sht 5)
2				Printed wiring board (see Sht 3)
1				Assembly, test fixture (see Sht 1)
C16	1		Vishay	0.01 μ F 500 V surface mount ceramic chip capacitor
C15	1			100 μ F / 200 V aluminum electrolytics radial lead capacitor
C14	1		Vishay	0.01 μ F 500 V surface mount ceramic chip capacitor
C13	1	ATC700B122MW50X	ATC	1200 pF ATC 700B Surface mount ceramic chip capacitor
C12	1	SKR470M1JF11V	MALLORY	47 μ F / 63 V aluminum electrolytics radial lead capacitor
C11	1	ATC200B103MW50X	ATC	10000 pF ATC 200B surface mount ceramic chip capacitor
C10	1	ATC200B103MW50X	ATC	10000 pF ATC 200B surface mount ceramic chip capacitor
C9	1	C1812X7R501-103KNE	Vishay	0.01 μ F / 500 V surface mount ceramic chip capacitor
C6		424	Arco	Variable capacitor
C5	1		ATC	750 pF ATC 700B surface mount ceramic chip capacitor

Table 7. Components list (continued)

Item	Qty	Part N°	Vendor	Description
C4	1		ATC	180 pF ATC 100B surface mount ceramic chip capacitor
C3	1		ATC	750 pF ATC 700B surface mount ceramic chip capacitor

6 Circuit layout

Figure 17. Test fixture component layout

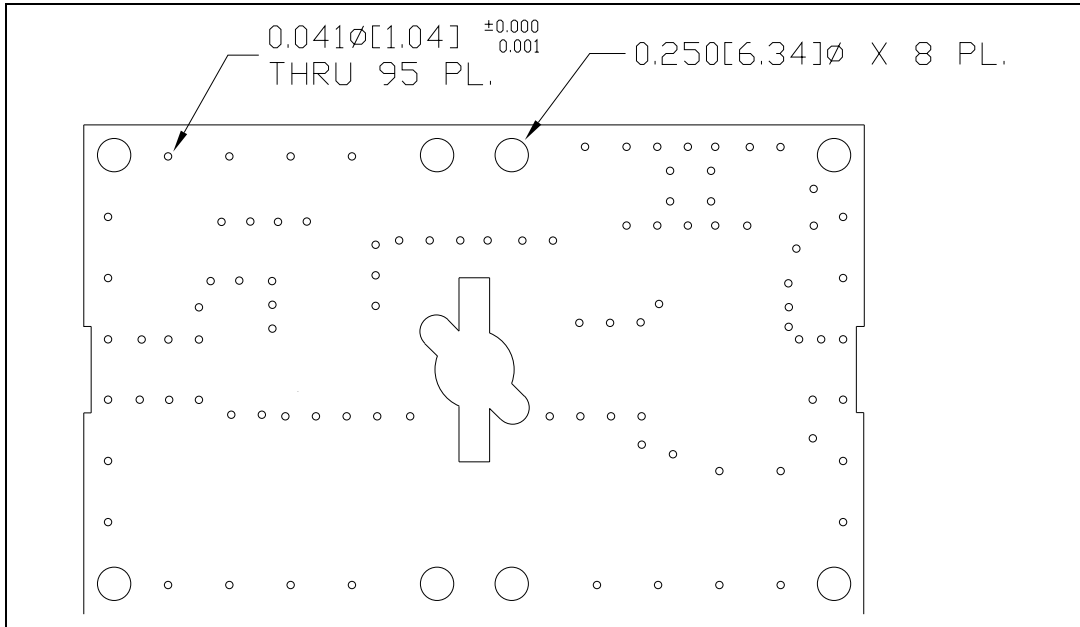
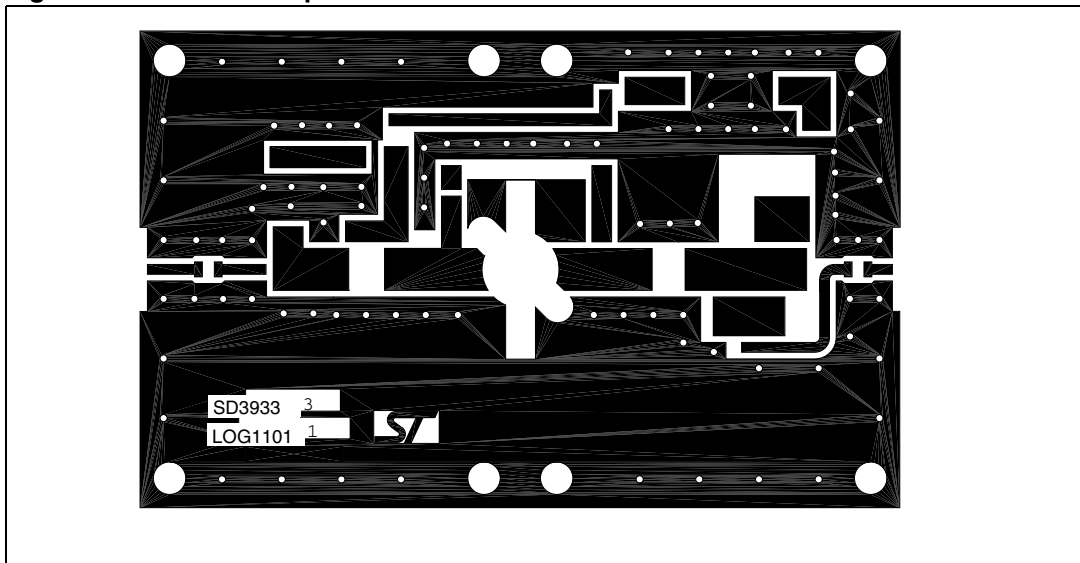

Figure 18. Test circuit photometers



7 VGS/GFS sorts

Table 8. VGS/GFS sorts

Marking	Vgs(min)	Vgs(max)	Gfs(min)	Gfs(max)
A1	1.50	1.75	5	6
A2	1.50	1.75	6	7
A3	1.50	1.75	7	8
A4	1.50	1.75	8	9
A5	1.50	1.75	9	10
A6	1.50	1.75	10	11
A7	1.50	1.75	11	12
A8	1.50	1.75	12	13
A9	1.50	1.75	13	14
B1	1.75	2.00	5	6
B2	1.75	2.00	6	7
B3	1.75	2.00	7	8
B4	1.75	2.00	8	9
B5	1.75	2.00	9	10
B6	1.75	2.00	10	11
B7	1.75	2.00	11	12
B8	1.75	2.00	12	13
B9	1.75	2.00	13	14
C1	2.00	2.25	5	6
C2	2.00	2.25	6	7
C3	2.00	2.25	7	8
C4	2.00	2.25	8	9
C5	2.00	2.25	9	10
C6	2.00	2.25	10	11
C7	2.00	2.25	11	12
C8	2.00	2.25	12	13
C9	2.00	2.25	13	14
D1	2.25	2.50	5	6
D2	2.25	2.50	6	7
D3	2.25	2.50	7	8
D4	2.25	2.50	8	9
D5	2.25	2.50	9	10

Table 8. VGS/GFS sorts (continued)

Marking	Vgs(min)	Vgs(max)	Gfs(min)	Gfs(max)
D6	2.25	2.50	10	11
D7	2.25	2.50	11	12
D8	2.25	2.50	12	13
D9	2.25	2.50	13	14
E1	2.50	2.75	5	6
E2	2.50	2.75	6	7
E3	2.50	2.75	7	8
E4	2.50	2.75	8	9
E5	2.50	2.75	9	10
E6	2.50	2.75	10	11
E7	2.50	2.75	11	12
E8	2.50	2.75	12	13
E9	2.50	2.75	13	14
F1	2.75	3.00	5	6
F2	2.75	3.00	6	7
F3	2.75	3.00	7	8
F4	2.75	3.00	8	9
F5	2.75	3.00	9	10
F6	2.75	3.00	10	11
F7	2.75	3.00	11	12
F8	2.75	3.00	12	13
F9	2.75	3.00	13	14
G1	3.00	3.25	5	6
G2	3.00	3.25	6	7
G3	3.00	3.25	7	8
G4	3.00	3.25	8	9
G5	3.00	3.25	9	10
G6	3.00	3.25	10	11
G7	3.00	3.25	11	12
G8	3.00	3.25	12	13
G9	3.00	3.25	13	14
H1	3.25	3.50	5	6
H2	3.25	3.50	6	7
H3	3.25	3.50	7	8
H4	3.25	3.50	8	9

Table 8. VGS/GFS sorts (continued)

Marking	Vgs(min)	Vgs(max)	Gfs(min)	Gfs(max)
H5	3.25	3.50	9	10
H6	3.25	3.50	10	11
H7	3.25	3.50	11	12
H8	3.25	3.50	12	13
H9	3.25	3.50	13	14
I1	3.50	3.75	5	6
I2	3.50	3.75	6	7
I3	3.50	3.75	7	8
I4	3.50	3.75	8	9
I5	3.50	3.75	9	10
I6	3.50	3.75	10	11
I7	3.50	3.75	11	12
I8	3.50	3.75	12	13
I9	3.50	3.75	13	14
J1	3.75	4.00	5	6
J2	3.75	4.00	6	7
J3	3.75	4.00	7	8
J4	3.75	4.00	8	9
J5	3.75	4.00	9	10
J6	3.75	4.00	10	11
J7	3.75	4.00	11	12
J8	3.75	4.00	12	13
J9	3.75	4.00	13	14

8 Package mechanical data

In order to meet environmental requirements, ST offers these devices in different grades of ECOPACK® packages, depending on their level of environmental compliance. ECOPACK® specifications, grade definitions and product status are available at: www.st.com. ECOPACK® is an ST trademark.

Table 9. M177 (.550 DIA 4/L N/HERM W/FLG) mechanical data

Dim.	mm.			Inch		
	Min	Typ	Max	Min	Typ	Max
A	5.72		5.97	0.225		0.235
B	6.73		6.96	0.265		0.275
C	21.84		22.10	0.860		0.870
D	28.70		28.96	1.130		1.140
E	13.84		14.10	0.545		0.555
F	0.08		0.18	0.003		0.007
G	2.49		2.74	0.098		0.108
H	3.81		4.32	0.150		0.170
I			7.11			0.280
J	27.43		28.45	1.080		1.120
K	15.88		16.13	0.625		0.635

Figure 19. Package dimensions

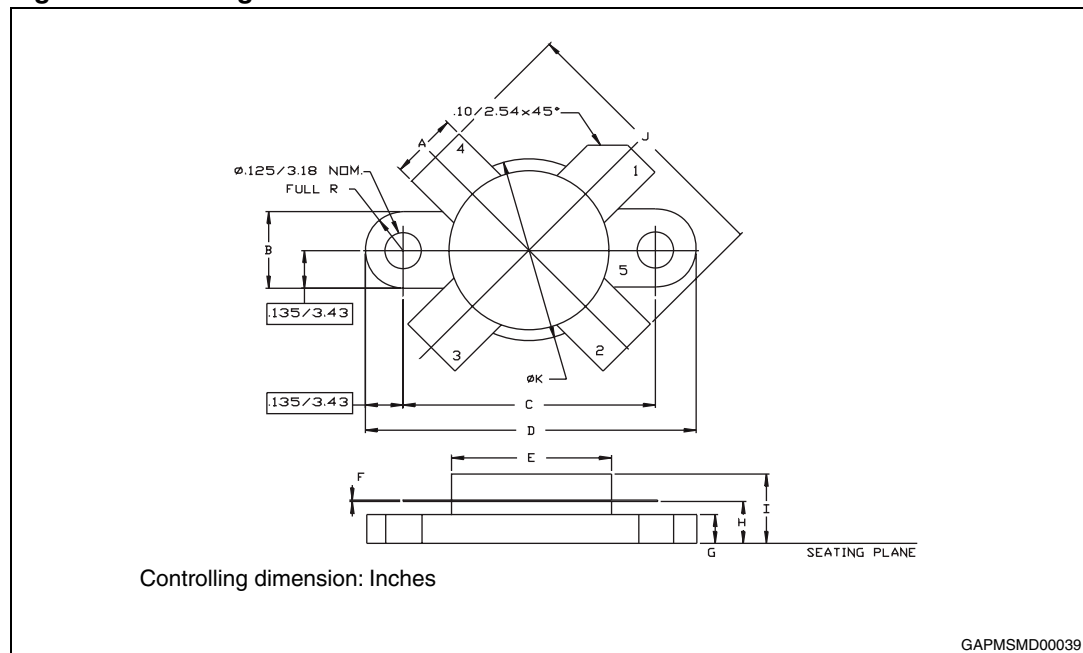

9 Marking, packing and shipping specifications

Table 10. Packing and shipping specifications

Order code	Packaging	Pcs per tray	Dry pack humidity	Vgs and Gfs code	Lot code
SD3933	Plastic tray	25	< 10 %	Not mixed	Not mixed

Figure 20. Marking layout

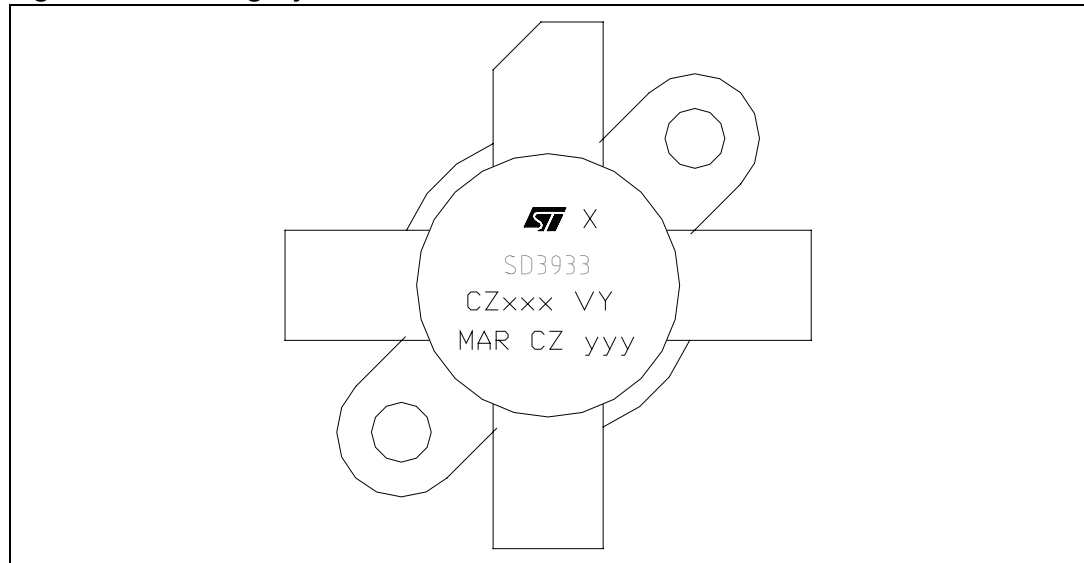

Table 11. Marking specifications

Symbol	Description
X	V _{GS} and G _{FS} sort
CZ	Assembly plant
xxx	Last 3 digit of diffusion lot
VY	Diffusion plant
MAR	Country of origin
CZ	Test and finishing plant
y	Assembly year
yy	Assembly week

10 Revision history

Table 12. Document revision history

Date	Revision	Changes
10-Jul-2004	1	First release
24-Jan-2006	2	Idss value updated
03-Jul-2007	3	Specification upgrade
07-Aug-2007	4	Added Table 8: VGS/GFS sorts on page 14
31-Oct-2007	5	Updated Table 4: Static on page 4
09-Oct-2008	6	Updated Table 8: VGS/GFS sorts on page 14
07-Sep-2010	7	Updated features on cover page.
12-Nov-2010	8	Updated package name.
27-Apr-2011	9	Updated Table 6: Impedance data (350 W load line) on page 5 . Added Section 9: Marking, packing and shipping specifications .
11-Aug-2011	10	– E _{AS} parameter inserted in Table 2: Absolute maximum ratings on page 3 . – Minor text changes.

Please Read Carefully:

Information in this document is provided solely in connection with ST products. STMicroelectronics NV and its subsidiaries ("ST") reserve the right to make changes, corrections, modifications or improvements, to this document, and the products and services described herein at any time, without notice.

All ST products are sold pursuant to ST's terms and conditions of sale.

Purchasers are solely responsible for the choice, selection and use of the ST products and services described herein, and ST assumes no liability whatsoever relating to the choice, selection or use of the ST products and services described herein.

No license, express or implied, by estoppel or otherwise, to any intellectual property rights is granted under this document. If any part of this document refers to any third party products or services it shall not be deemed a license grant by ST for the use of such third party products or services, or any intellectual property contained therein or considered as a warranty covering the use in any manner whatsoever of such third party products or services or any intellectual property contained therein.

UNLESS OTHERWISE SET FORTH IN ST'S TERMS AND CONDITIONS OF SALE ST DISCLAIMS ANY EXPRESS OR IMPLIED WARRANTY WITH RESPECT TO THE USE AND/OR SALE OF ST PRODUCTS INCLUDING WITHOUT LIMITATION IMPLIED WARRANTIES OF MERCHANTABILITY, FITNESS FOR A PARTICULAR PURPOSE (AND THEIR EQUIVALENTS UNDER THE LAWS OF ANY JURISDICTION), OR INFRINGEMENT OF ANY PATENT, COPYRIGHT OR OTHER INTELLECTUAL PROPERTY RIGHT.

UNLESS EXPRESSLY APPROVED IN WRITING BY TWO AUTHORIZED ST REPRESENTATIVES, ST PRODUCTS ARE NOT RECOMMENDED, AUTHORIZED OR WARRANTED FOR USE IN MILITARY, AIR CRAFT, SPACE, LIFE SAVING, OR LIFE SUSTAINING APPLICATIONS, NOR IN PRODUCTS OR SYSTEMS WHERE FAILURE OR MALFUNCTION MAY RESULT IN PERSONAL INJURY, DEATH, OR SEVERE PROPERTY OR ENVIRONMENTAL DAMAGE. ST PRODUCTS WHICH ARE NOT SPECIFIED AS "AUTOMOTIVE GRADE" MAY ONLY BE USED IN AUTOMOTIVE APPLICATIONS AT USER'S OWN RISK.

Resale of ST products with provisions different from the statements and/or technical features set forth in this document shall immediately void any warranty granted by ST for the ST product or service described herein and shall not create or extend in any manner whatsoever, any liability of ST.

ST and the ST logo are trademarks or registered trademarks of ST in various countries.

Information in this document supersedes and replaces all information previously supplied.

The ST logo is a registered trademark of STMicroelectronics. All other names are the property of their respective owners.

© 2011 STMicroelectronics - All rights reserved

STMicroelectronics group of companies

Australia - Belgium - Brazil - Canada - China - Czech Republic - Finland - France - Germany - Hong Kong - India - Israel - Italy - Japan - Malaysia - Malta - Morocco - Philippines - Singapore - Spain - Sweden - Switzerland - United Kingdom - United States of America

www.st.com