

LOW QUIESCENT CURRENT VOLTAGE REGULATOR

- ADJUSTABLE OUTPUT VOLTAGE FROM 0.8V to $V_I - V_d$
- INTERNAL REFERENCE VOLTAGE ACCURACY $\pm 2\%$ AT 25°C
- OUTPUT CURRENT CAPABILITY: 1A MINIMUM
- VERY LOW QUIESCENT CURRENT: MAX 3mA OVER TEMPERATURE RANGE
- MAXIMUM DROPOUT 1V (@ $I_O=1A$)
- STABLE ONLY WITH LOW ESR CERAMIC CAPACITORS
- THERMAL SHUTDOWN PROTECTION WITH HYSTERESIS
- OVER CURRENT PROTECTION
- OPERATING JUNCTION TEMPERATURE RANGE: FROM 0 TO 125°C

DESCRIPTION

The ST1L04 is a low drop adjustable linear voltage regulator capable to supply up to 1A output current.

The output voltage can be as low as 0.8V. The quiescent current is well controlled and maintained below 3mA over the whole allowed

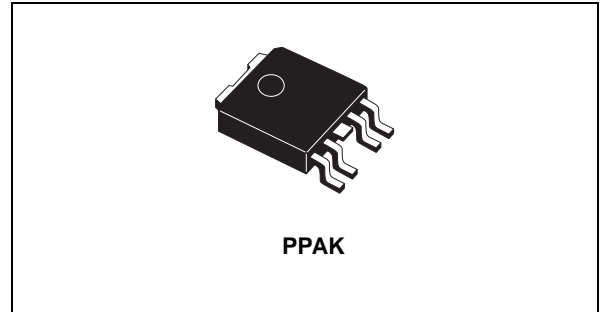

junction temperature range. The ST1L04 is stable only with low ESR output ceramic capacitors. Internal protection circuitry includes thermal protection with hysteresis and over current limiting.

The ST1L04 is especially suitable for applications requiring low voltage outputs from low voltage inputs. Typical application for this product are, notebook PCs, low voltage ASIC, VID power supplies and low cost post regulation for 3.3V output voltage switching regulators.

Figure 1: Schematic Diagram

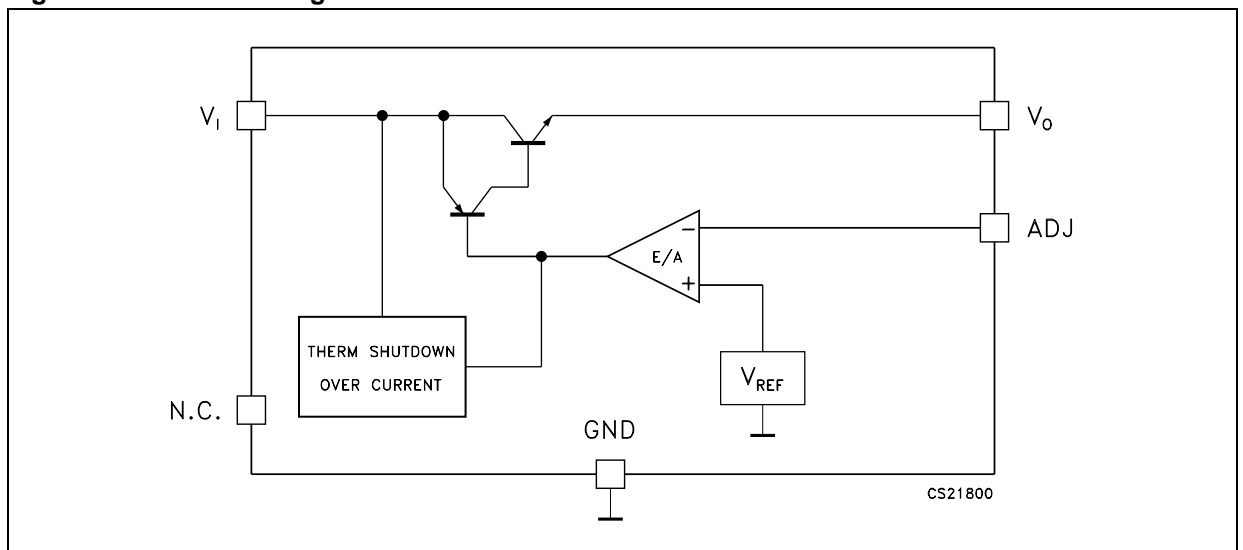

Table 1: Order Codes

TYPE	PPAK
ST1L04	ST1L04PT

Figure 2: Pin Connection (top view)

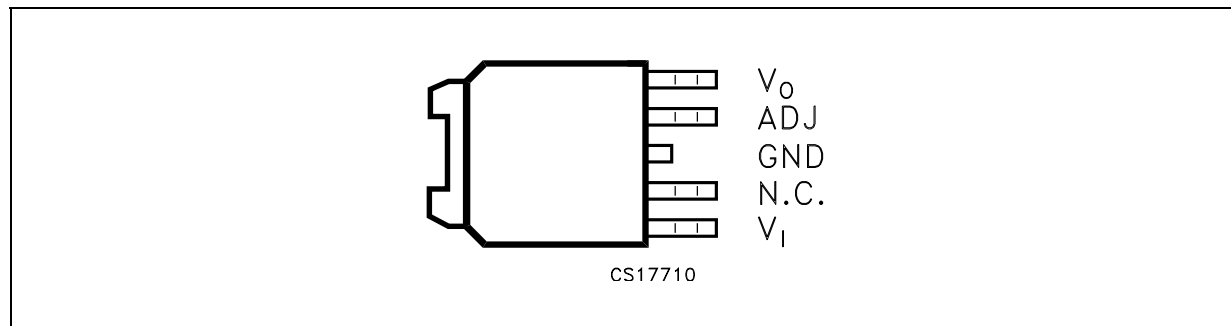

Table 2: Pin Description

PIN N°	NAME	FUNCTION
1	V _I	Supply voltage input pin. Bypass with a ceramic capacitor to GND
2	N.C.	Not connected.
3	GND	Ground. The exposed metallic pad of the package is connected to GND.
4	ADJ	Adjust voltage pin. External resistor divider connection.
5	V _O	Output voltage pin. Bypass with a ceramic capacitor to GND

Table 3: Absolute Maximum Ratings

Symbol	Parameter	Value	Unit
V _I	DC Supply Voltage	from GND-0.3 to 10	V
P _{tot}	Power Dissipation	internally limited	W
I _O	Output Current	internally limited	A
T _{op}	Operating Junction Temperature Range	0 to +125	°C
T _{stg}	Storage Temperature Range	-40 to +150	°C

Absolute Maximum Ratings are those values beyond which damage to the device may occur. Functional operation under these condition is not implied.

Table 4: Thermal Data

Symbol	Parameter	PPAK	Unit
R _{thj-case}	Thermal Resistance Junction-case	8	°C/W
R _{thj-amb}	Thermal Resistance Junction-ambient	100	°C/W

Figure 3: Typical Application Schematic

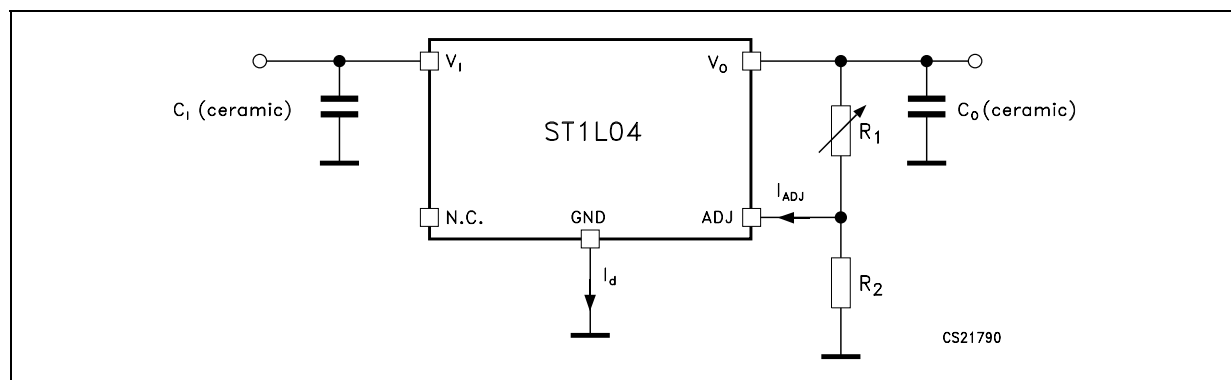

NOTE: The adjustable output voltage is set by a resistor divider connected between V_O and GND with its centre tap connected to ADJ. The voltage divider resistor are: R1 connected between V_O and ADJ and R2 connected between ADJ and GND. V_O is determined by V_{REF} , R1, R2, I_{ADJ} , as follows:

$$V_O = V_{REF}(1 + R1/R2) + I_{ADJ}R1$$

Since I_{ADJ} is very small and stable it can be ignored and the output voltage can be simply calculated as follows:

$$V_O = V_{REF}(1 + R1/R2)$$

Table 5: Electrical Characteristics (refer to the typical application schematic, V_{IN} =from 2.9 to 5.5V, I_O = from 10mA to 1A, C_{IN} =4.7 μ F, C_{OUT} =4.7 μ F, T_j = 0 to 125 $^{\circ}$ C, unless otherwise specified). Typical values are intended at T_j =25 $^{\circ}$ C unless otherwise specified

Symbol	Parameter	Test Conditions	Min.	Typ.	Max.	Unit
V_I	Operating Input Voltage		2.8			V
I_d	Quiescent Current				3	mA
V_{REF}	Reference Voltage	$T_j = 25^{\circ}\text{C}$	0.784	0.8	0.816	V
			0.776	0.8	0.824	
ΔV_O	Line Regulation	$I_O = 10\text{mA}$			0.8	%
ΔV_O	Load Regulation	$V_I = 3.3\text{V}$			0.8	%
I_{ADJ}	Adjustment Current	$I_O = 10\text{mA}$			1	μA
$I_{\Delta ADJ}$	Adjustment Current change				200	nA
I_{Omin}	Minimum Output Current for regulation				100	μA
I_O	Output Current Limit		1		1.4	A
V_d	Dropout Voltage (see note 1 and note 2)	$I_O = 1\text{A}$, $V_O = \text{from } 1.8 \text{ to } 3.3\text{V}$			1	V
SVR	Supply Voltage Rejection (see note 2)	$V_I = 3.3 \pm 0.5\text{V}$, $I_O = 10\text{mA}$, $T_j = 25^{\circ}\text{C}$	$f = 120\text{Hz}$	50		dB
			$f = 100\text{kHz}$	20		
C_O	Ceramic Output capacitor value		2.2			μF
C_{ESR}	Output Capacitor ESR value				200	m Ω
eN	Output Noise Voltage (see note 2)	B = from 10Hz to 10kHz, $V_I = 3.3\text{V}$, $I_O = 10\text{mA}$, $T_j = 25^{\circ}\text{C}$		0.003		% V_O
T_{SH}	Thermal shutdown trip point (see note 2)	$V_I = 3.3\text{V}$		165		$^{\circ}\text{C}$
T_{HY}	Thermal Shutdown hysteresis (see note 2)	$V_I = 3.3\text{V}$		5		$^{\circ}\text{C}$

NOTE 1: This parameter is the minimum input to output differential voltage required to maintain 1% regulation with respect to the V_O nominal value. For V_O between 0.8V and 1.8V included, the V_d value is overridden by the minimum operating input voltage.

NOTE 2: Guaranteed by design. Not tested in production.

TYPICAL CHARACTERISTICS

Figure 4: Output Voltage vs Temperature

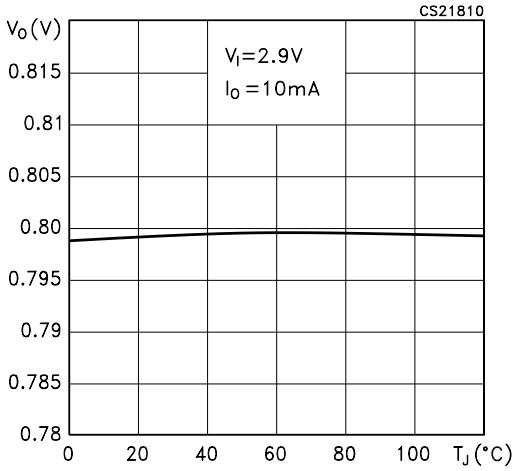

Figure 5: Output Voltage vs Temperature

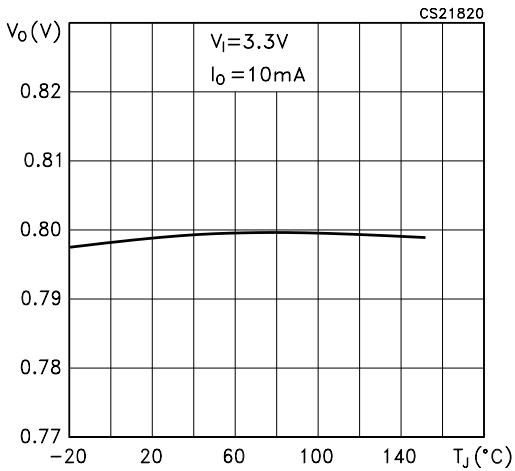

Figure 6: Line Regulation vs Temperature

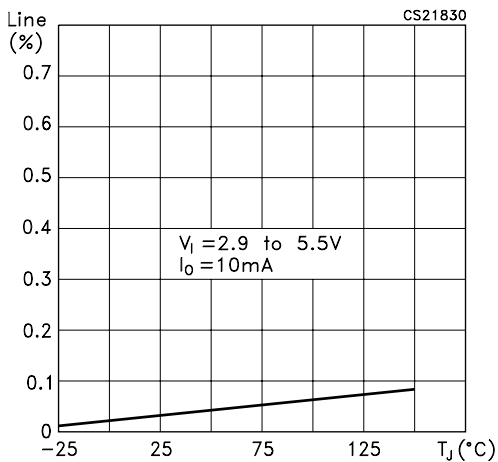

Figure 7: Load Regulation vs Temperature

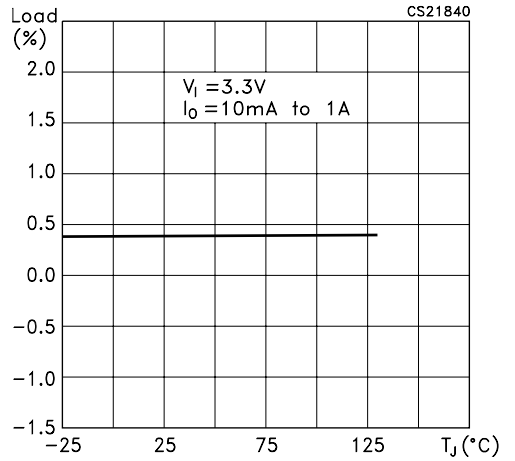

Figure 8: Quiescent Current vs Temperature

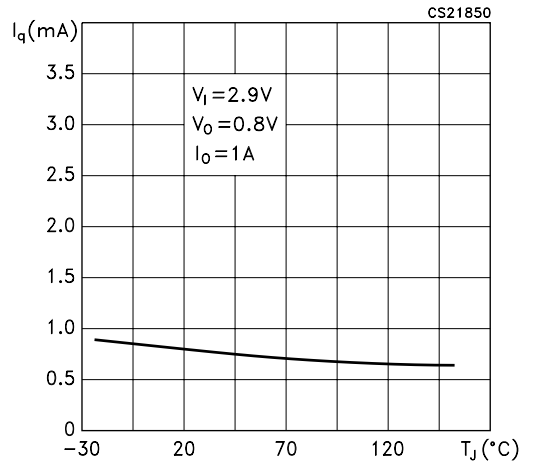

Figure 9: Quiescent Current vs Temperature

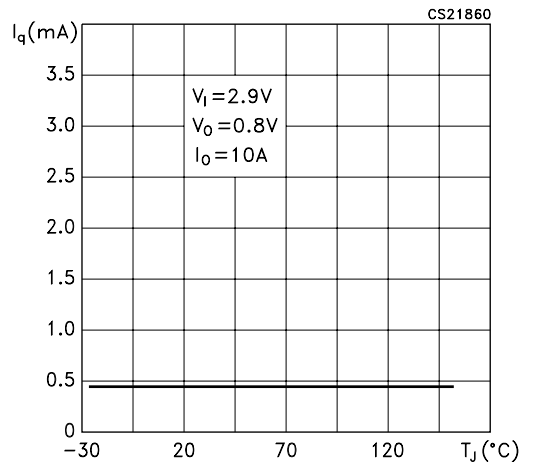

Figure 10: Quiescent Current vs Output Current

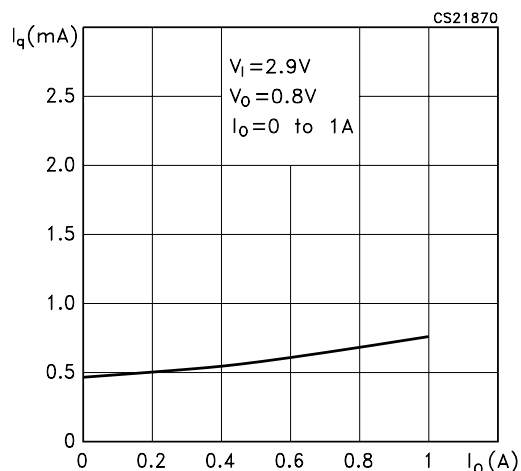

Figure 11: Quiescent Current vs Input Voltage

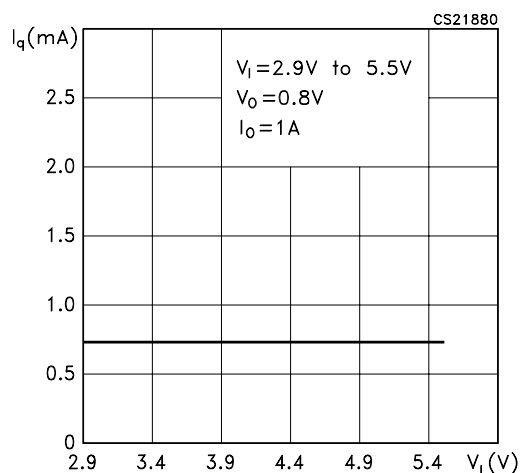

Figure 12: Dropout Voltage vs Temperature

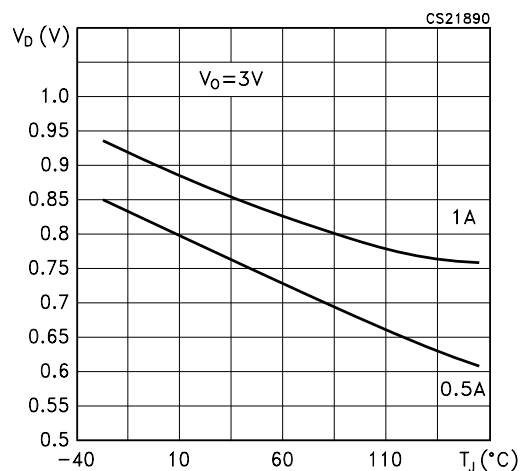

Figure 13: Dropout Voltage vs Output Current

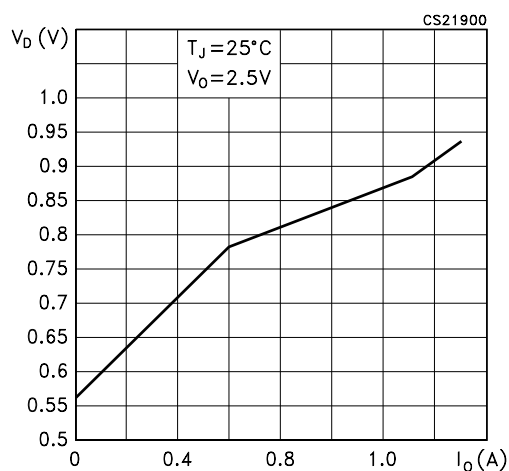

Figure 14: Supply Ripple Rejection vs Temperature

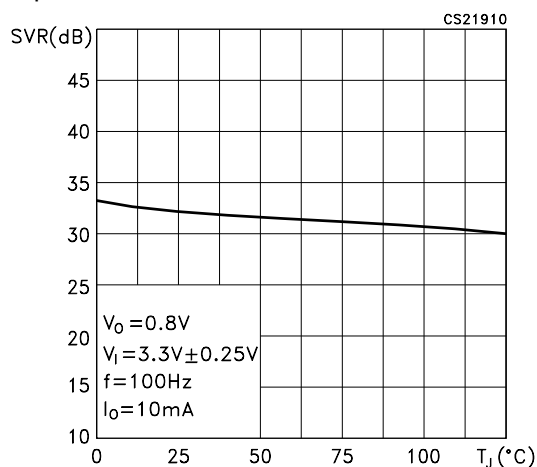

Figure 15: Supply Ripple Rejection vs Temperature

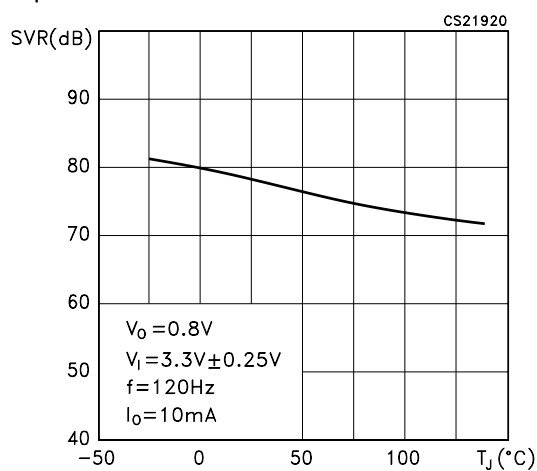

Figure 16: Supply Ripple Rejection vs Output Current

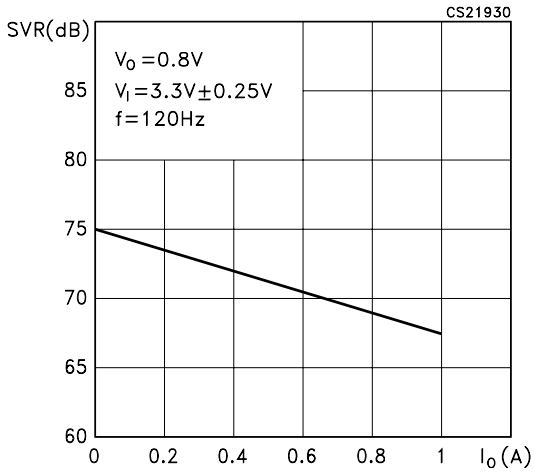

Figure 19: Adjustment Current change vs Temperature

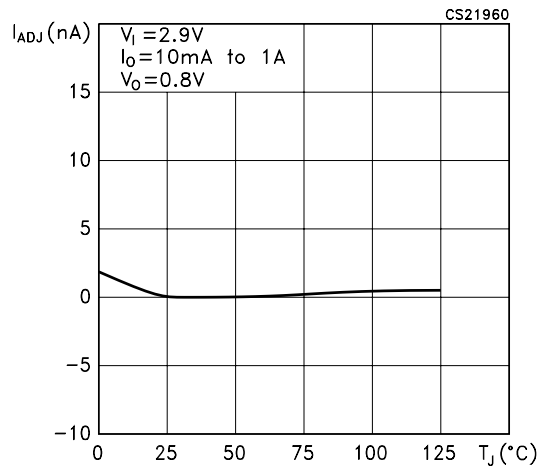

Figure 17: Supply Ripple Rejection vs Frequency

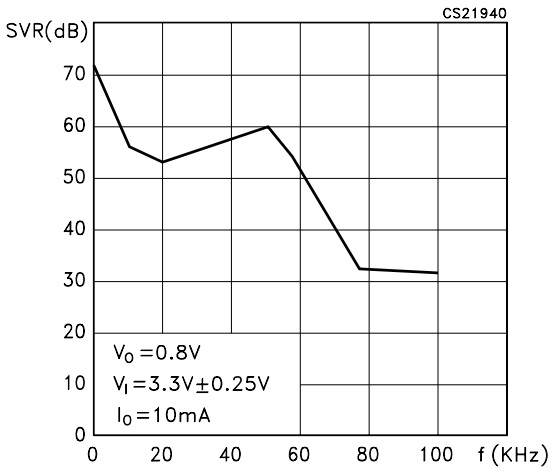

Figure 20: Minimum Output Current for Regulation vs Temperature

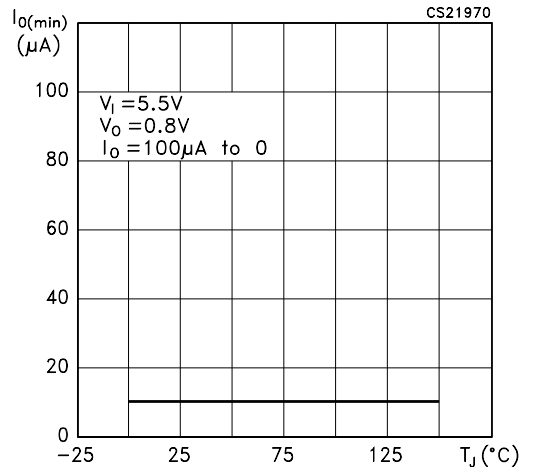

Figure 18: Adjustment Current vs Temperature

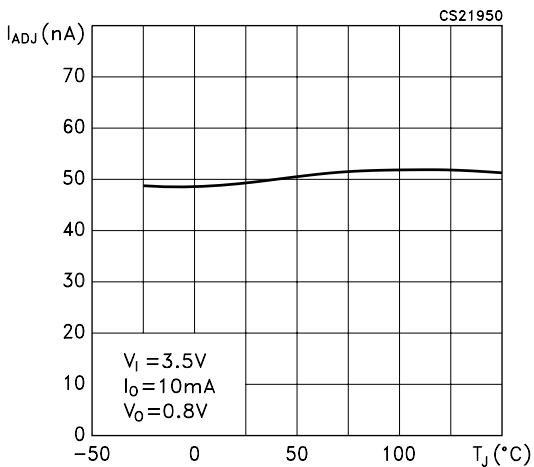

Figure 21: Minimum Output Current for Regulation vs Temperature

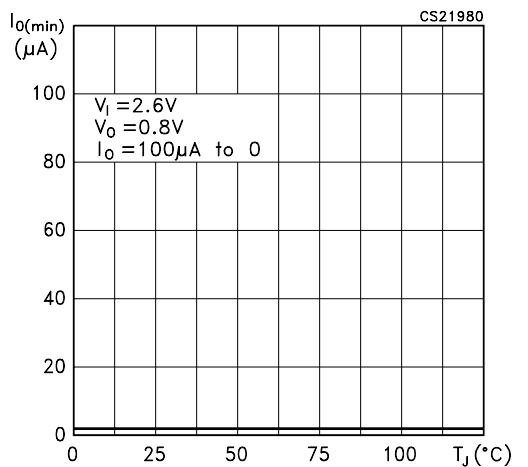
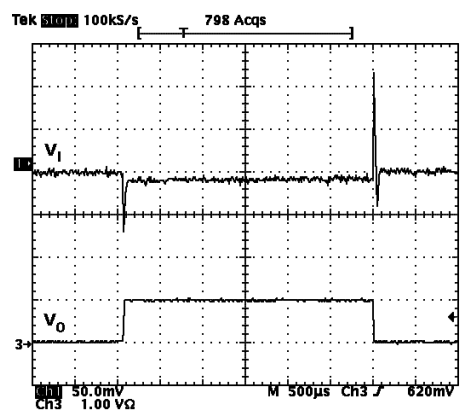
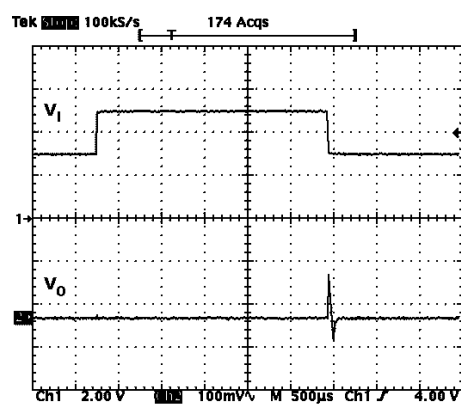

Figure 22: Load Transient



$V_I=4V$, $I_O=10mA$ to $1A$, $C_O=4.7\mu F$, $C_I=4.7\mu F$, $T_J=25^\circ C$

Figure 23: Line Transient



$V_I=3V$ to $5V$, $I_O=250mA$, NO C_I , $T_J=25^\circ C$, $t_{RISE}=t_{FALL}=3\mu s$

PPAK MECHANICAL DATA

DIM.	mm.			inch		
	MIN.	TYP	MAX.	MIN.	TYP.	MAX.
A	2.2		2.4	0.086		0.094
A1	0.9		1.1	0.035		0.043
A2	0.03		0.23	0.001		0.009
B	0.4		0.6	0.015		0.023
B2	5.2		5.4	0.204		0.212
C	0.45		0.6	0.017		0.023
C2	0.48		0.6	0.019		0.023
D	6		6.2	0.236		0.244
D1		5.1			0.201	
E	6.4		6.6	0.252		0.260
E1		4.7			0.185	
e		1.27			0.050	
G	4.9		5.25	0.193		0.206
G1	2.38		2.7	0.093		0.106
H	9.35		10.1	0.368		0.397
L2		0.8	1		0.031	0.039
L4	0.6		1	0.023		0.039
L5	1			0.039		
L6		2.8			0.110	

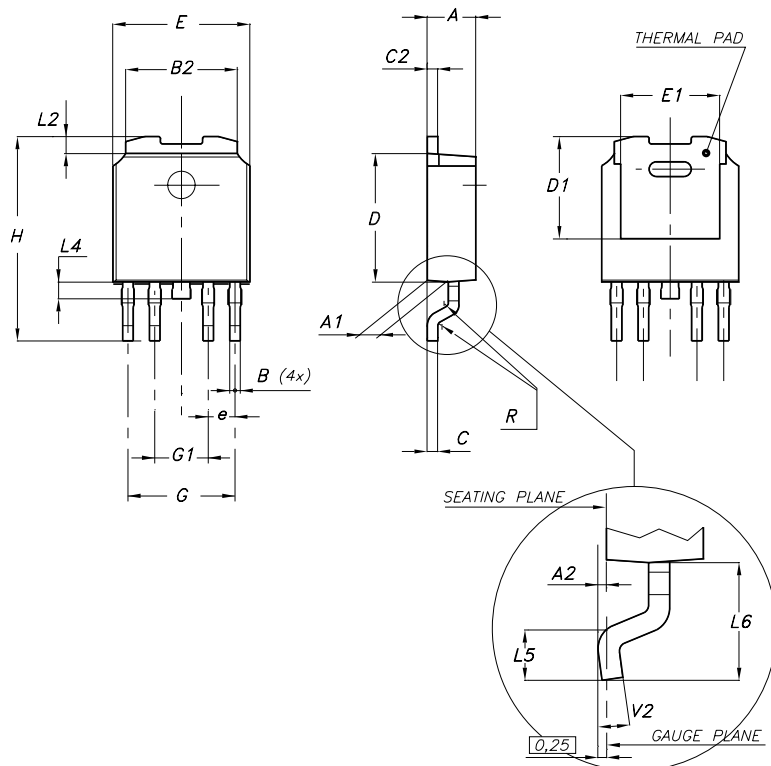

0078180-E

Tape & Reel DPAK-PPAK MECHANICAL DATA

DIM.	mm.			inch		
	MIN.	TYP	MAX.	MIN.	TYP.	MAX.
A			330			12.992
C	12.8	13.0	13.2	0.504	0.512	0.519
D	20.2			0.795		
N	60			2.362		
T			22.4			0.882
Ao	6.80	6.90	7.00	0.268	0.272	0.276
Bo	10.40	10.50	10.60	0.409	0.413	0.417
Ko	2.55	2.65	2.75	0.100	0.104	0.105
Po	3.9	4.0	4.1	0.153	0.157	0.161
P	7.9	8.0	8.1	0.311	0.315	0.319

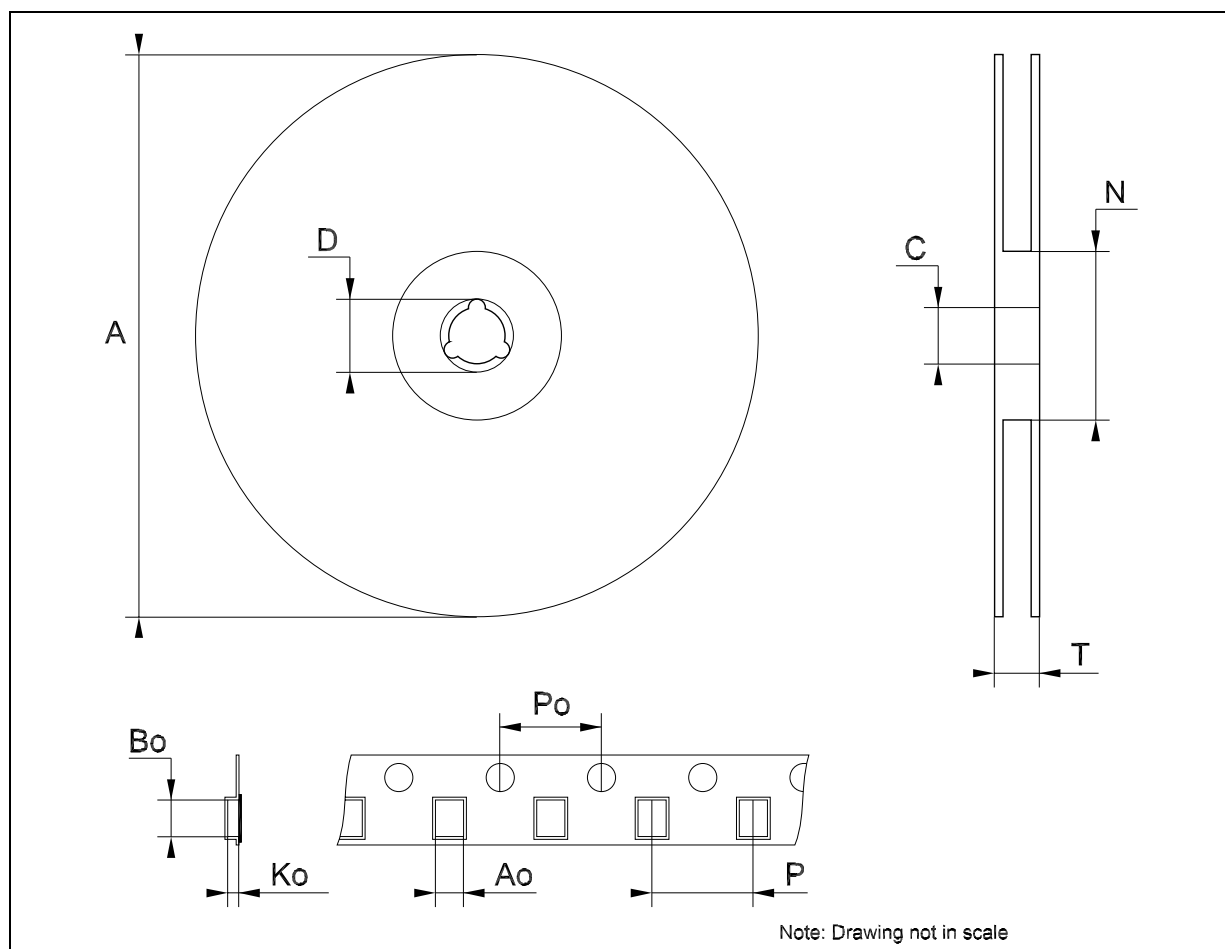

Table 6: Revision History

Date	Revision	Description of Changes
10-Feb-2005	1	First Release.

Information furnished is believed to be accurate and reliable. However, STMicroelectronics assumes no responsibility for the consequences of use of such information nor for any infringement of patents or other rights of third parties which may result from its use. No license is granted by implication or otherwise under any patent or patent rights of STMicroelectronics. Specifications mentioned in this publication are subject to change without notice. This publication supersedes and replaces all information previously supplied. STMicroelectronics products are not authorized for use as critical components in life support devices or systems without express written approval of STMicroelectronics.

The ST logo is a registered trademark of STMicroelectronics

All other names are the property of their respective owners

© 2005 STMicroelectronics - All Rights Reserved

STMicroelectronics group of companies

Australia - Belgium - Brazil - Canada - China - Czech Republic - Finland - France - Germany - Hong Kong - India - Israel - Italy - Japan - Malaysia - Malta - Morocco - Singapore - Spain - Sweden - Switzerland - United Kingdom - United States of America

www.st.com