



STFN42

HIGH VOLTAGE FAST-SWITCHING NPN POWER TRANSISTOR

PRELIMINARY DATA

Ordering Code	Marking	Package / Shipment
STFN42	N42	SOT-89 / Tape & Reel

- MEDIUM VOLTAGE CAPABILITY
- LOW SPREAD OF DYNAMIC PARAMETERS
- MINIMUM LOT-TO-LOT SPREAD FOR RELIABLE OPERATION
- VERY HIGH SWITCHING SPEED

APPLICATIONS:

- ELECTRONIC BALLASTS FOR FLUORESCENT LIGHTING
- BATTERY CHARGER

DESCRIPTION

The device is manufactured using high voltage Multi Epitaxial Planar technology for high switching speeds and medium voltage capability.

It uses a Cellular Emitter structure with planar edge termination to enhance switching speeds while maintaining the wide RBSOA.

The STFN42 is designed for use in compact fluorescent lamp application.

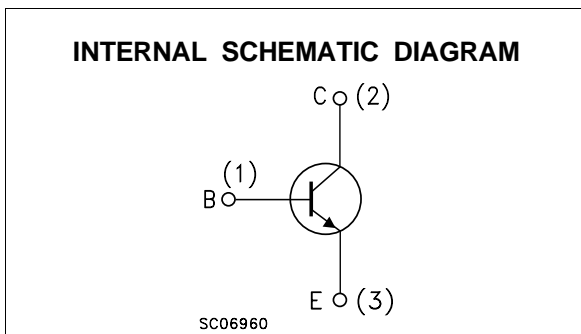
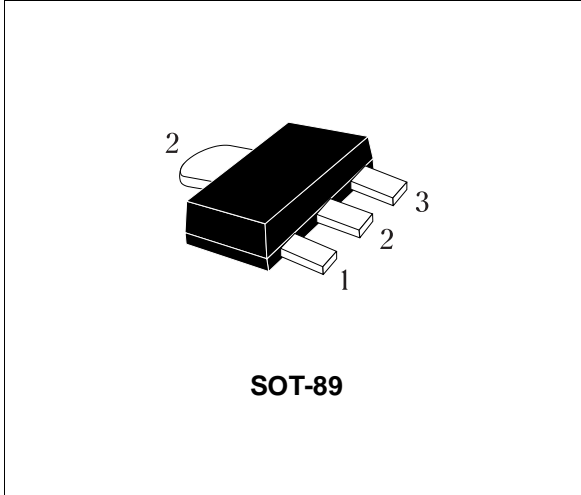

ABSOLUTE MAXIMUM RATINGS

Symbol	Parameter	Value	Unit
V_{CES}	Collector-Emitter Voltage ($V_{BE} = 0$)	700	V
V_{CEO}	Collector-Emitter Voltage ($I_B = 0$)	400	V
V_{EBO}	Emitter-Base Voltage ($I_C = 0$)	9	V
I_C	Collector Current	1	A
I_{CM}	Collector Peak Current ($t_p < 5$ ms)	2	A
I_B	Base Current	0.5	A
I_{BM}	Base Peak Current ($t_p < 5$ ms)	1	A
P_{tot}	Total Dissipation at $T_{amb} = 25$ °C	1.4	W
T_{stg}	Storage Temperature	-65 to 150	°C
T_j	Max. Operating Junction Temperature	150	°C

THERMAL DATA

$R_{thj-amb}$	Thermal Resistance Junction-ambient	Max	90	$^{\circ}\text{C}/\text{W}$
---------------	-------------------------------------	-----	----	-----------------------------

• Device mounted on a PCB area of 1 cm^2 .

ELECTRICAL CHARACTERISTICS ($T_{case} = 25\text{ }^{\circ}\text{C}$ unless otherwise specified)

Symbol	Parameter	Test Conditions	Min.	Typ.	Max.	Unit
I_{CEV}	Collector Cut-off Current ($V_{BE} = -1.5\text{V}$)	$V_{CE} = 700\text{ V}$			1	mA
		$V_{CE} = 700\text{ V}$ $T_j = 125^{\circ}$			5	mA
I_{EBO}	Emitter Cut-off Current ($I_C = 0$)	$V_{EB} = 9\text{ V}$			1	mA
$V_{CEO(sus)}^*$	Collector-Emitter Sustaining Voltage ($I_B = 0$)	$I_C = 1\text{ mA}$ $L = 25\text{mH}$	400			V
$V_{CE(sat)}^*$	Collector-Emitter Saturation Voltage	$I_C = 0.25\text{ A}$ $I_B = 0.05\text{ A}$		0.2	0.5	V
		$I_C = 0.5\text{ A}$ $I_B = 0.125\text{ A}$		0.3	1	V
		$I_C = 0.75\text{ A}$ $I_B = 0.25\text{ A}$		0.4	1.5	V
$V_{BE(sat)}^*$	Base-Emitter Saturation Voltage	$I_C = 0.25\text{ A}$ $I_B = 0.05\text{ A}$			1	V
		$I_C = 0.5\text{ A}$ $I_B = 0.125\text{ A}$			1.2	V
h_{FE}^*	DC Current Gain	$I_C = 0.4\text{ A}$ $V_{CE} = 5\text{ V}$	10		30	
		$I_C = 0.8\text{ A}$ $V_{CE} = 5\text{ V}$	5		20	
t_f	INDUCTIVE LOAD Fall Time	$I_C = 0.25\text{ A}$ $V_{clamp} = 300\text{ V}$ $I_{B1} = -I_{B2} = 50\text{ mA}$ $L = 3\text{ mH}$		0.3		μs

* Pulsed: Pulse duration = $300\mu\text{s}$, duty cycle = 1.5 %

DC Current Gain

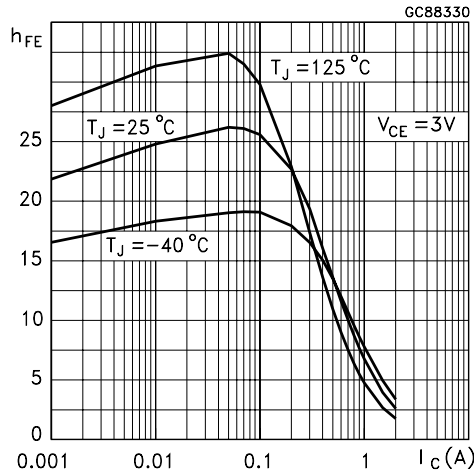

DC Current Gain

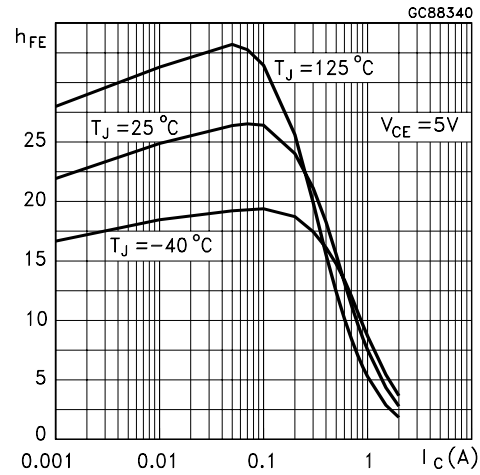

Collector Emitter Saturation Voltage

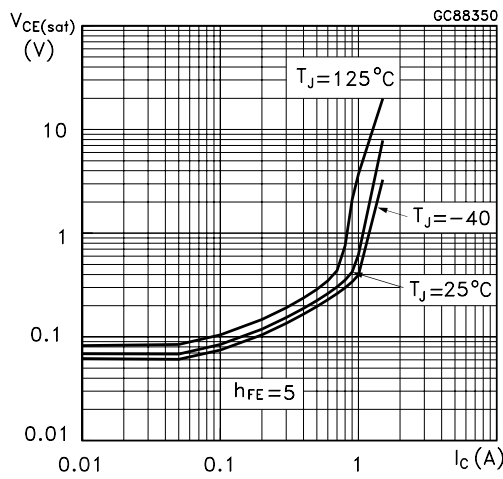

Base Emitter Saturation Voltage

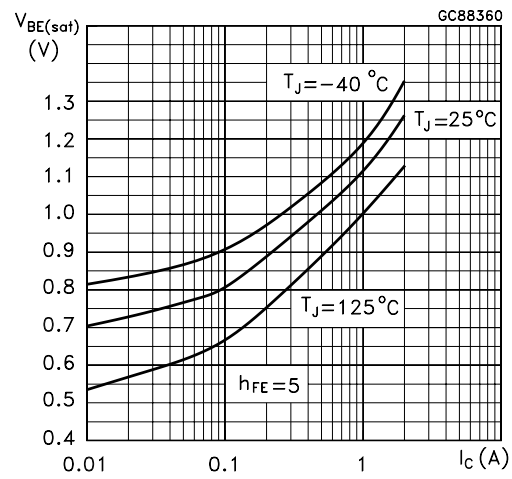

Switching Time Inductive Load

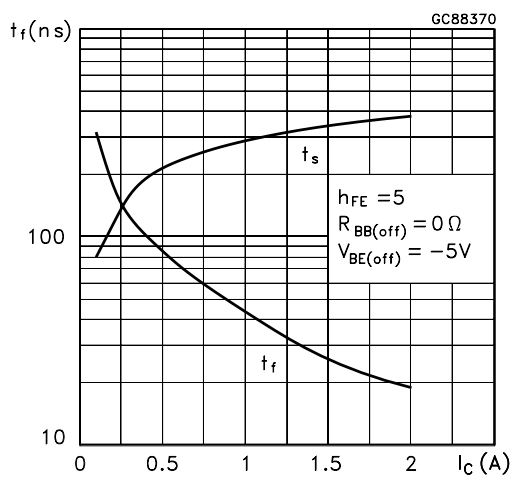

SOT-89 MECHANICAL DATA

DIM.	mm			mils		
	MIN.	TYP.	MAX.	MIN.	TYP.	MAX.
A	1.4		1.6	55.1		63.0
B	0.44		0.56	17.3		22.0
B1	0.36		0.48	14.2		18.9
C	0.35		0.44	13.8		17.3
C1	0.35		0.44	13.8		17.3
D	4.4		4.6	173.2		181.1
D1	1.62		1.83	63.8		72.0
E	2.29		2.6	90.2		102.4
e	1.42		1.57	55.9		61.8
e1	2.92		3.07	115.0		120.9
H	3.94		4.25	155.1		167.3
L	0.89		1.2	35.0		47.2

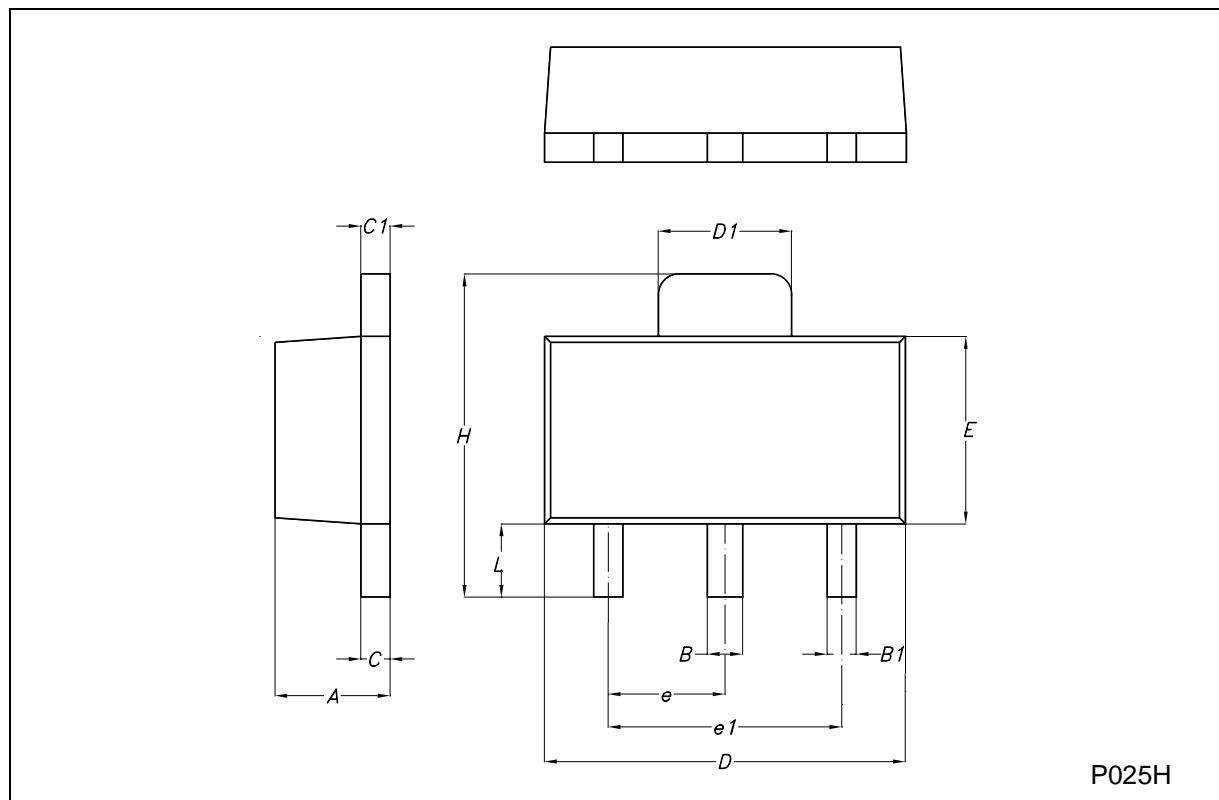

P025H

Information furnished is believed to be accurate and reliable. However, STMicroelectronics assumes no responsibility for the consequences of use of such information nor for any infringement of patents or other rights of third parties which may result from its use. No license is granted by implication or otherwise under any patent or patent rights of STMicroelectronics. Specification mentioned in this publication are subject to change without notice. This publication supersedes and replaces all information previously supplied. STMicroelectronics products are not authorized for use as critical components in life support devices or systems without express written approval of STMicroelectronics.

The ST logo is a trademark of STMicroelectronics.

All other names are the property of their respective owners.

© 2004 STMicroelectronics – All Rights reserved
STMicroelectronics GROUP OF COMPANIES

Australia - Belgium - Brazil - Canada - China - Czech Republic - Finland - France - Germany - Hong Kong - India - Israel - Italy - Japan - Malaysia - Malta - Morocco - Singapore - Spain - Sweden - Switzerland - United Kingdom - United States.

<http://www.st.com>