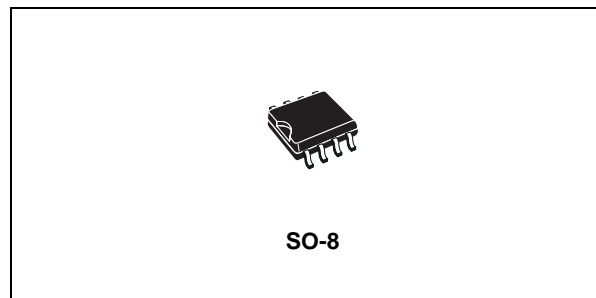




## FORWARD SYNCHRONOUS RECTIFIERS SMART DRIVER

- SUPPLY VOLTAGE RANGE: 4.5V TO 5.5V
- TYPICAL PEAK OUTPUT CURRENT:  
SOURCE -2A, SINK 3.5A
- OPERATING FREQUENCY: 20 TO 750 KHZ
- SMART TURN-OFF ANTICIPATION TIMING
- OPERATION INDEPENDENT FROM THE  
FORWARD MAGNETIC RESET TECHNIQUE
- POSSIBILITY TO OPERATE IN  
DISCONTINUOUS MODE

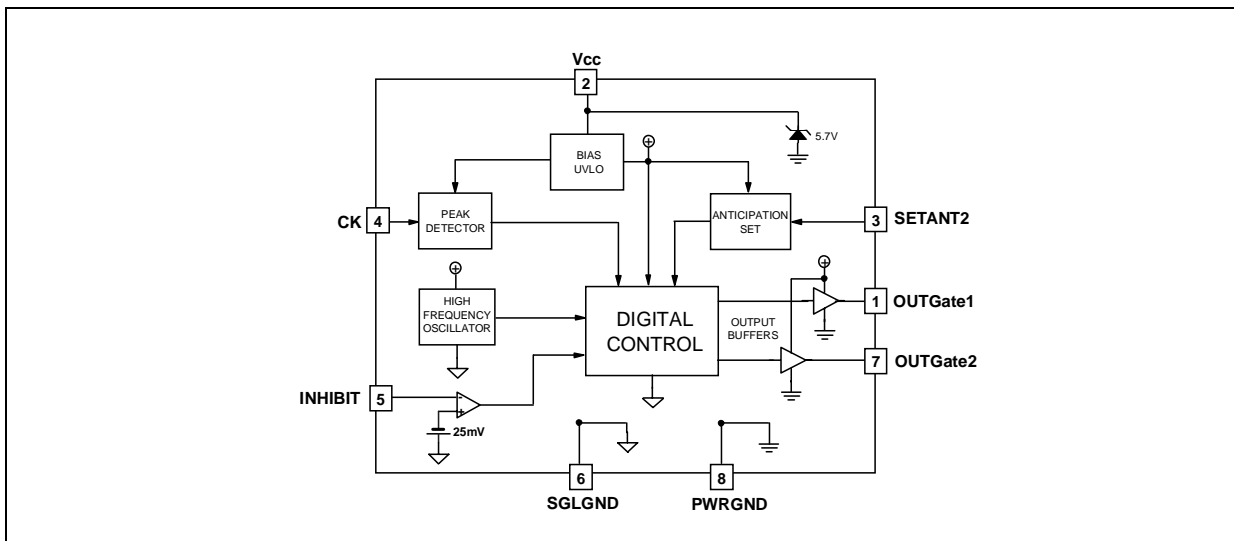


### DESCRIPTION

STSR2P Smart Driver IC provides two complementary high current outputs to drive Power Mosfets. The IC is dedicated to properly drive secondary Synchronous Rectifiers in medium power, low output voltage, high efficiency Forward Converters. From a synchronizing clock input, STSR2P generates two driving signals with the self-setting of dead time between complementary pulses. The IC operation prevents secondary side shoot-through conditions providing proper timing at the outputs turn-off transition. This smart function operates through a fast cycle-after-cycle control logic mechanism based on an internal high frequency oscillator, synchronized by the clock signal. A fixed

anticipation in turning-off the  $OUT_{GATE1}$  with respect to the clock signal transition is provided, while the anticipation in turning off the  $OUT_{GATE2}$  can be set through external components. The adopted transitions revelation mechanism makes circuit operation independent by the forward magnetic reset technique used, avoiding most of the common problems inherent in self-driven synchronous rectifiers. A special Inhibit function allows the shut-off of  $OUT_{GATE2}$ . This feature makes discontinuous conduction mode possible and prevents the freewheeling mosfet from sinking current from the output. STSR2P automatically turns off the outputs when duty-cycle is lower than 13%, while STSR2PM works even at very low duty-cycle values.

### SCHEMATIC DIAGRAM



## STSR2P/STSR2PM

### ABSOLUTE MAXIMUM RATINGS

Symbol	Parameter	Value	Unit	
$V_{CC}$	DC Input Voltage	-0.3 to 6	V	
$V_{OUTGATE}$	Max Gate Drive Output Voltage	-0.3 to $V_{CC}$	V	
$V_{INHIBIT}$	Max INHIBIT Voltage (*)	-0.6 to $V_{CC}$	V	
$V_{CK}$	Clock Input Voltage Range (*)	-0.3 to $V_{CC}$	V	
$I_{LX}$	Switching Peak Current	2	A	
$P_{TOT}$	Continuous Power Dissipation at $T_A=105^{\circ}\text{C}$ without heatsink	270	mW	
ESD	Human Body Model	Pins 1,2, 4, 5, 6, 7, 8	$\pm 1$	KV
		Pin 3	$\pm 0.9$	KV
$T_{stg}$	Storage Temperature Range	-55 to +150	$^{\circ}\text{C}$	
$T_{op}$	Operating Junction Temperature Range	-40 to +125	$^{\circ}\text{C}$	

Absolute Maximum Ratings are those values beyond which damage to the device may occur. Functional operation under these condition is not implied.

(\*) A higher positive voltage level can be applied to the pin with a resistor which limits the current flowing into the pin to 10mA maximum

### THERMAL DATA

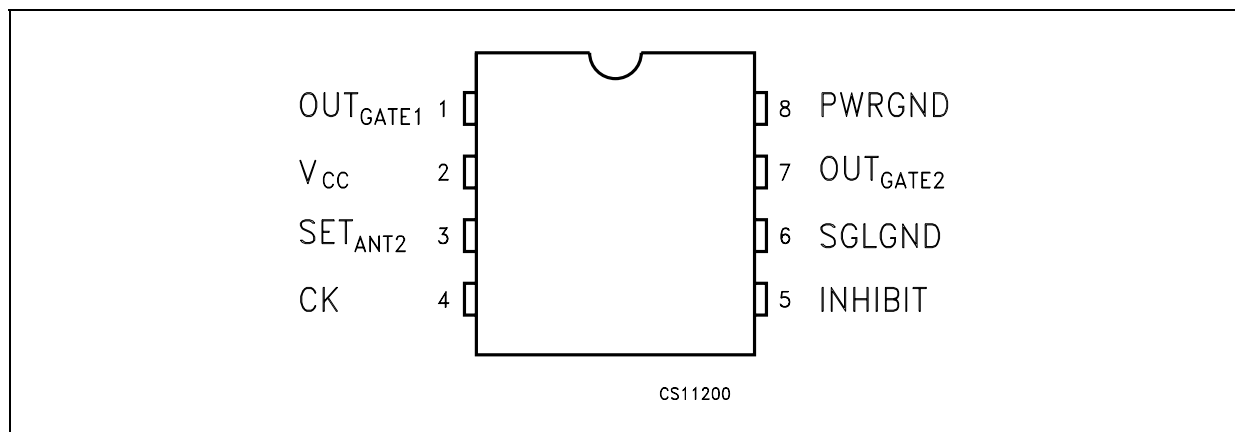
Symbol	Parameter	SO-8	Unit
$R_{thj-amb}$	Thermal Resistance Junction-case	40	$^{\circ}\text{C}/\text{W}$
$R_{thj-amb}$	Thermal Resistance Junction-ambient (*)	160	$^{\circ}\text{C}/\text{W}$

(\*) This value is referred to one layer pcb board with minimum copper connections for the leads. a minimum value of 120  $^{\circ}\text{C}/\text{W}$  can be obtained improving thermal conductivity of the board

### ORDERING CODES

TYPE	SO-8	SO-8 (T&R)
STSR2P	STSR2PCD	STSR2PCD-TR
STSR2PM	STSR2PMCD	STSR2PMCD-TR

### CONNECTION DIAGRAM (top view)



## PIN DESCRIPTION

Pin N°	Symbol	Name and Function
1	OUT <sub>GATE1</sub>	Gate Drive signal for Rectifier MOSFET. Anticipation ( $t_{ANT1}$ ) in turning off OUT <sub>GATE1</sub> is provided when the clock input goes to low level.
2	V <sub>CC</sub>	The supply voltage range from 4.5V to 5.5V allows applications with logic gate threshold mosfets. UVLO feature guarantees proper start-up while it avoids undesirable driving during eventual dropping of the supply voltage.
3	SET <sub>ANT2</sub>	The voltage on this pin sets the anticipation ( $t_{ANT1}$ ) in turning off the OUT <sub>GATE2</sub> . It is possible to choose among three different anticipation times by discrete partitioning of the supply voltage.
4	CK	This input provides synchronization for IC's operations, being the transitions between the two output conditions based on a positive threshold, equal for the two slopes. A smart internal control logic mechanism using a 15MHz internal oscillator generates proper anticipation timing at the turn-off of each output. This feature allows safe turn-off of Synchronous Rectifiers avoiding any eventual shoot-through situation on secondary side at both transitions. Smart clock revelation mechanism makes these operations independent by false triggering pulses generated in light load conditions and by particular demagnetization techniques. Absolute maximum voltage rating of the pin can be exceeded limiting the current flowing into the pin to 10mA max.
5	INHIBIT	This input enables OUT <sub>GATE2</sub> to work when its voltage is lower than the negative threshold voltage ( $V_{INHIBIT} < V_H$ ). If $V_{INHIBIT} > V_H$ the OUT <sub>GATE2</sub> will be high for a minimum conduction time ( $t_{ON(GATE2)}$ ). In typical forward converter application, it is possible to turn off the freewheeling MOSFET when the current through it tends to reverse, allowing discontinuous conduction mode and providing protection to the converter from eventual sinking current from the load. Absolute maximum voltage rating of the pin can be exceeded limiting the current flowing into the pin to 10mA max.
6	SGLGND	Reference for all the control logic signals. This pin is completely separated from the PWRGND to prevent eventual disturbances to affect the control logic.
7	OUT <sub>GATE2</sub>	Gate Drive signal for Freewheeling MOSFET. Anticipation [ $t_{ANT2}$ ] in turning off OUT <sub>GATE2</sub> is provided when the clock input goes to high level.
8	PWRGND	Reference for power signals, this pin carries the full peak currents for the two outputs.

## STSR2P/STSR2PM

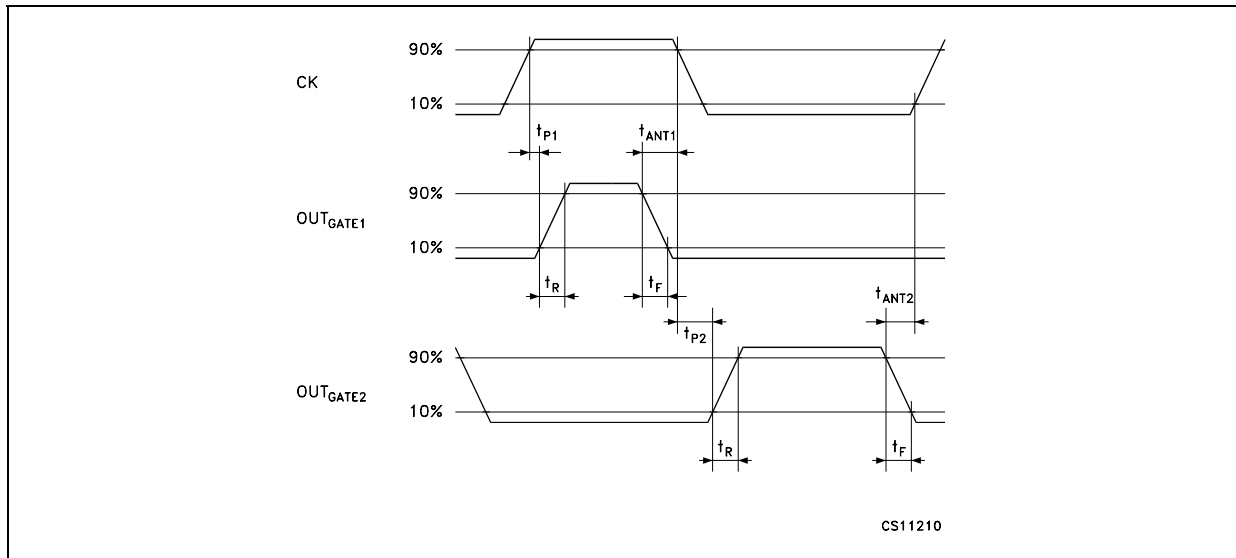
**ELECTRICAL CHARACTERISTICS** ( $V_{CC}=5V$ ,  $CK=250kHz$ ,  $V_{INHIBIT}=-200mV$ ,  $T_J=-40$  to  $125^{\circ}C$ , unless otherwise specified.)

Symbol	Parameter	Test Conditions	Min.	Typ.	Max.	Unit
<b>SUPPLY INPUT AND UNDER VOLTAGE LOCK OUT</b>						
$V_{CCON}$	Start Threshold			3.8	4	V
$V_{CCOFF}$	Turn OFF Threshold After Start		3.5	3.6		V
$V_Z$	Zener Voltage	$CK=0V$ $I_Z = 2mA$	5.5	5.8	6	V
$I_{CC}$	Unloaded Supply Current	$OUT_{GATE1,2}=$ no load		22	30	mA
		$CK=0V$ $OUT_{GATE1,2}=$ no load		3	5	
<b>GATE DRIVER OUTPUTS</b>						
$V_{OL}$	Output Low Voltage	$I_{OUTGATE1,2}=-200mA$		0.10	0.16	V
$V_{OH}$	Output High Voltage	$I_{OUTGATE1,2}=200mA$	4.70	4.85		V
$I_{OUT}$	Output Source Peak Current			2		A
	Output Sink Peak Current			3.5		
$R_{OUT}$	Output Series Source Resistance	$I_{OUTGATE1,2}=-200mA$		0.75	1.5	$\Omega$
	Output Series Sink Resistance	$I_{OUTGATE1,2}=200mA$		0.5	0.8	
$t_R$	$OUT_{GATE1,2}$ Rise Time	$C_{LOAD}=5nF$ (Note 1)		40		ns
$t_F$	$OUT_{GATE1,2}$ Fall Time	$C_{LOAD}=5nF$ (Note 1)		30		ns
$t_{P1}$	Clock Propagation Delay to Turn ON of $OUT_{GATE1}$	No Load		130		ns
$t_{P2}$	Clock Propagation Delay to Turn ON of $OUT_{GATE2}$	No Load		50		ns
<b>TURN-OFF ANTICIPATION TIME</b>						
$t_{ANT1}$	$OUT_{GATE1}$ Turn-off Anticipation Time	No Load		75		ns
$t_{ANT2}$	$OUT_{GATE2}$ Turn-off Anticipation Time	$V_{ANT2} = 0$ to $1/3V_{CC}$ ; no load		75		ns
		$V_{ANT2} = 1/3V_{CC}$ to $2/3V_{CC}$ ; no load		150		
		$V_{ANT2} = 2/3V_{CC}$ to $V_{CC}$ ; no load		225		
$I_{SETANT2}$	Leakage Current (Note 2)		-0.1		0.1	$\mu A$
<b>INHIBIT <math>OUT_{GATE2}</math> ENABLE</b>						
$V_H$	Threshold Voltage	$T_J = 25^{\circ}C$	-30	-25		mV
$I_H$	Leakage Current (Note 2)	$V_{INHIBIT} = 200mV$		-400		nA
		$V_{INHIBIT} = -200mV$			1	$\mu A$
$t_{ON(GATE2)}$	$OUT_{GATE1}$ Turn-off Anticipation Time	$V_{INHIBIT} = 200mV$ No Load		250		ns
$V_{CK}$	Reference Voltage	$T_J = 25^{\circ}C$		2.6	2.8	V
$I_{CK}$	LX Leakage Current				600	$\mu A$
$D_{OFF}$	Duty Cycle Shut Down	$T_J = 25^{\circ}C$ for STSR2P	13	14		%
	Duty Cycle Turn ON after Shut Down	$T_J = 25^{\circ}C$ for STSR2P		18	20	
$t_{PW}$	Minimum Pulse Width	STSR2PM			200	ns

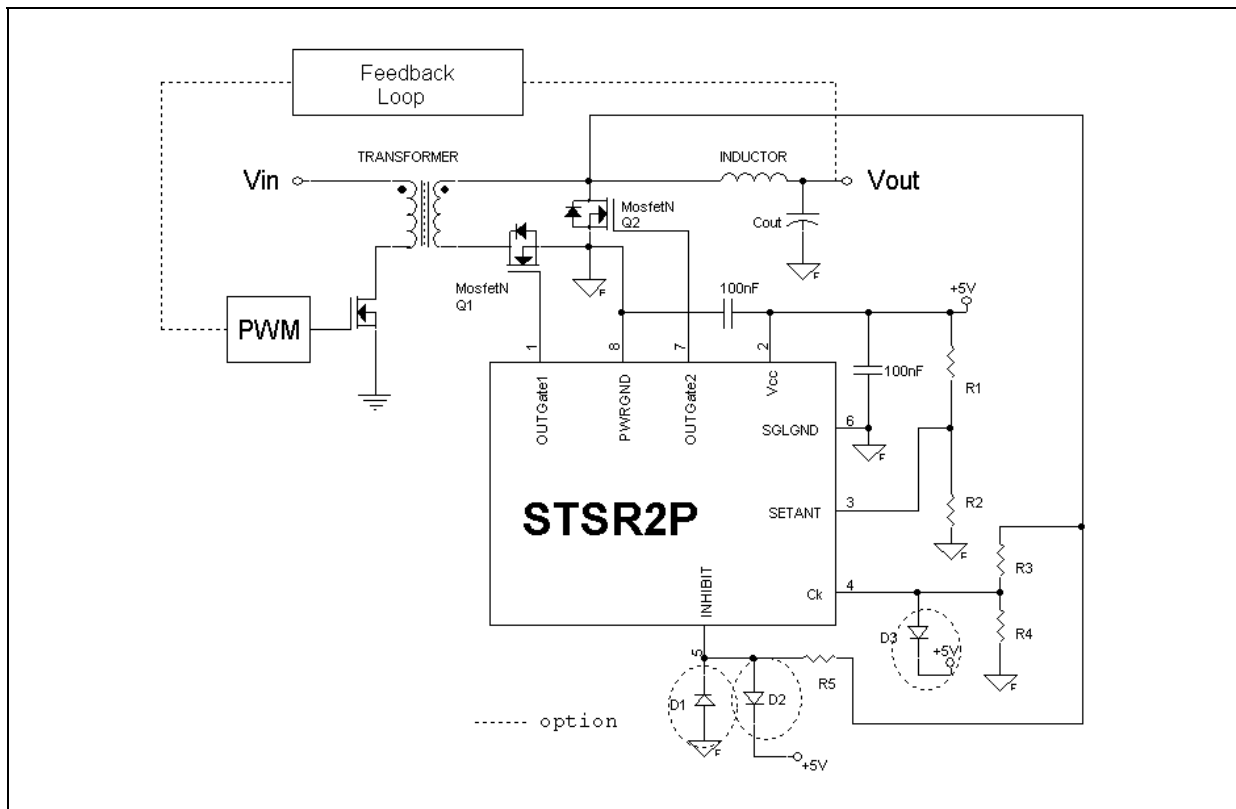
Note1:  $t_R$  is measured between 10% and 90% of the final voltage;  $t_F$  is measured between 90% and 10% on the initial voltage

Note2: Parameter guaranteed by design

TIMING DIAGRAM



APPLICATION INFORMATION: STSR2 IN FORWARD CONVERTER SECONDARY SIDE



NOTES

- 1) Ceramic Capacitors C1 and C2 must be placed very close to the IC;
- 2) R1 and R2 set the anticipation time by partitioning the V<sub>CC</sub> voltage;
- 3) R3 and R4 is a resistor divider meant to provide the correct CK voltage range;
- 4) R5 limits the current flowing through diode D2 when Freewheeling drain voltage is high;
- 5) D1 could be necessary to protect INHIBIT pin from negative voltages.
- 6) D2 could be necessary to protect INHIBIT pin from voltages higher than V<sub>CC</sub>
- 7) D3 could be necessary to protect CK pin from voltages higher than V<sub>CC</sub>.
- 8) SGLGND layout trace must not include OUT<sub>GATE1,2</sub> current paths.
- 9) A capacitor in parallel with R4 could be necessary to eliminate turn off voltage spike.

**EXAMPLE OF COMPONENTS SELECTION FOR A FORWARD CONVERTER**

Forward Specification:

$$V_{IN}=36-72V$$

$$V_{OUT}=3.3V$$

$$n=N_p/N_s=4.5$$

R<sub>3</sub> and R<sub>4</sub> are calculated assuring a minimum voltage of 2.8V at CK pin. At 36V input, the voltage on the secondary winding is 36/4.5=8V. Choosing R<sub>3</sub>=1.5kΩ, R<sub>4</sub> results to be:

$$R_4 \geq \frac{V_{CK} \times R_3}{V_{IN} - I_{CK(2.8)} \times R_3 - V_{CK}} = 1k\Omega \times \frac{2.8V \times (1.5k\Omega)}{8V - 220\mu A \times 1.5k\Omega - 2.8V} = 862\Omega$$

R<sub>4</sub>=1kΩ is chosen. At 72V input the current at CK pin is calculated as:

$$I_{CK} = \frac{V_{IN(max)} - V_{CC} - 0.3}{R_3} = \frac{16 - 5 - 0.3}{1.5k\Omega} = 7.13mA$$

This value is below the maximum allowable current flowing into the CK pin (10mA). If the 10mA value is exceeded an external diode connected to V<sub>CC</sub> must be added (D3).

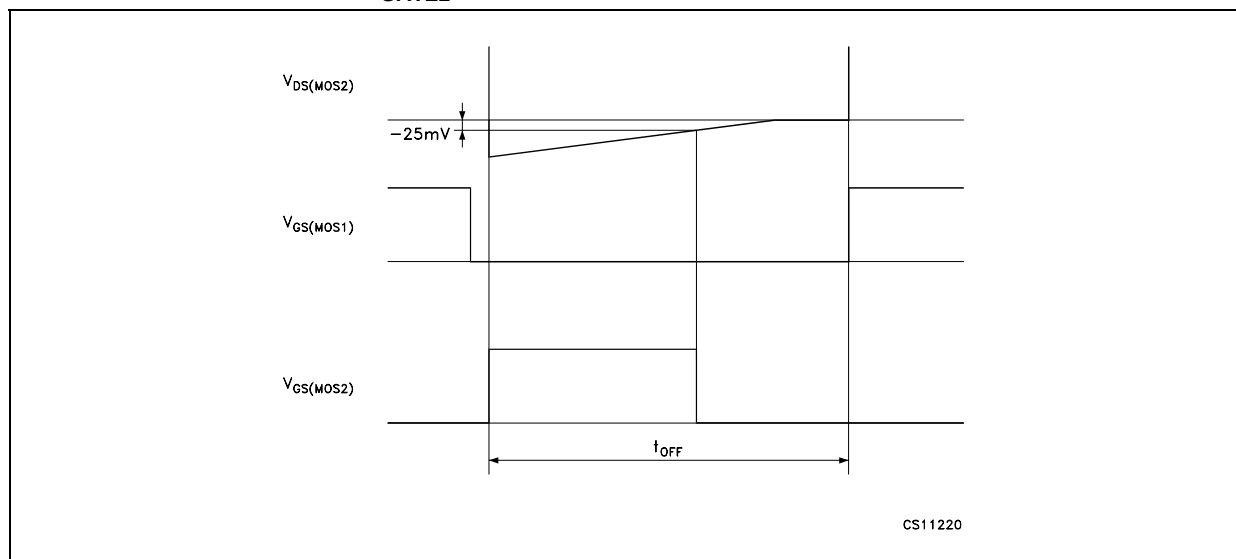
R<sub>1</sub> and R<sub>2</sub> values set the anticipation time for OUT<sub>GATE2</sub>. For R<sub>1</sub>=∞ and R<sub>2</sub>=0, t<sub>ANT2</sub>=75ns; for R<sub>1</sub>=R<sub>2</sub>=10kΩ, t<sub>ANT2</sub>=150ns; for R<sub>1</sub>=0 and R<sub>2</sub>=∞, t<sub>ANT2</sub>=225ns.

The RC group composed by R<sub>5</sub> and the parasitic capacitance of Inhibit pin (typically 5pF) delays the signal on Inhibit comparator. This delay must be lower than 200ns. This condition imposes a maximum value for R<sub>5</sub> of about 20kΩ.

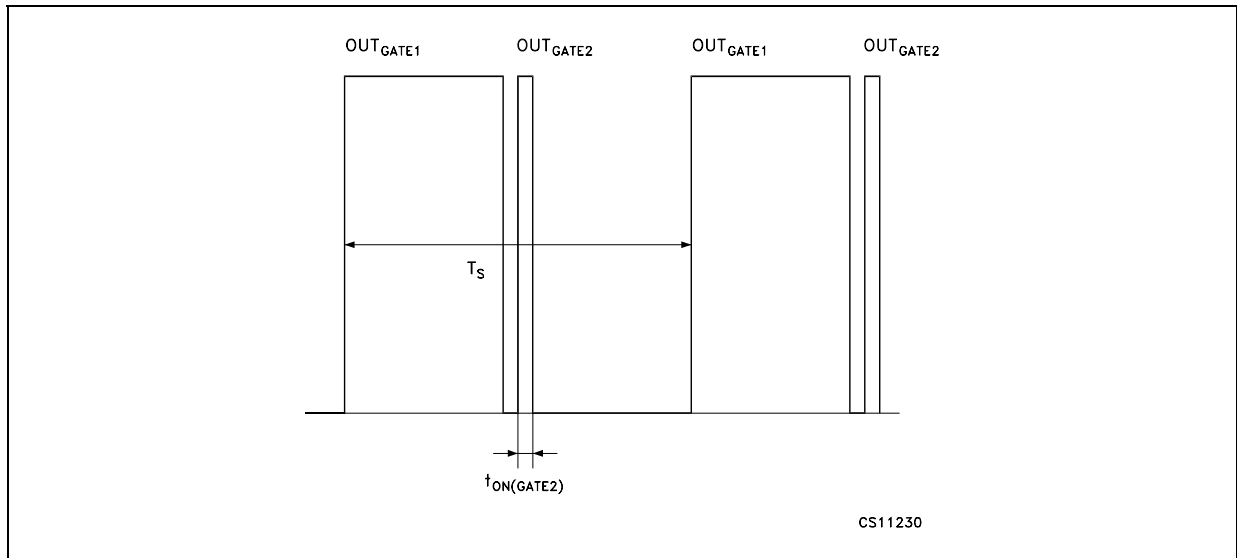
In general a suggested value for R<sub>5</sub> is 10kΩ. At 72V input, the secondary voltage is 16V, so the maximum current flowing into Inhibit pin is 16V/10kΩ=1.6mA which is below the maximum allowable current for the pin (10mA). If the 10mA value is exceeded an external diode (D2) connected to V<sub>CC</sub> must be added.

The maximum negative voltage of -0.6V must be guaranteed for the Inhibit pin. If this negative voltage is exceeded the current must be limited to 50mA. If necessary, a diode (D1) connected to SGLGND can be added to satisfy this specification.

**INHIBIT OPERATION OF OUT<sub>GATE2</sub> IN DISCONTINUOUS CONDUCTION MODE**



CS11220

INHIBIT OPERATION OF  $OUT_{GATE2}$ NOTE:  $V_{INHIBIT} = +200mV$

TYPICAL PERFORMANCE CHARACTERISTICS (unless otherwise specified  $T_j = 25^\circ\text{C}$ )

Figure 1 : Zener Characteristics

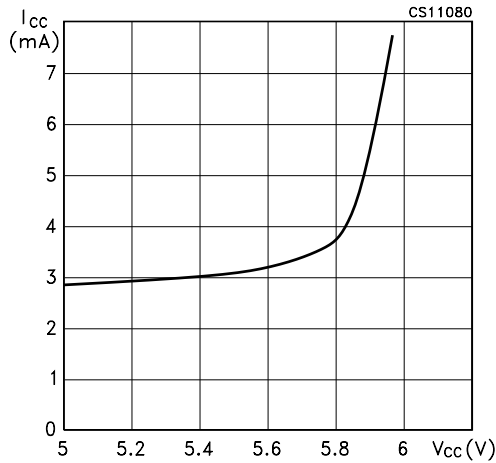


Figure 4 : Sink-Source ON Resistance vs Temperature

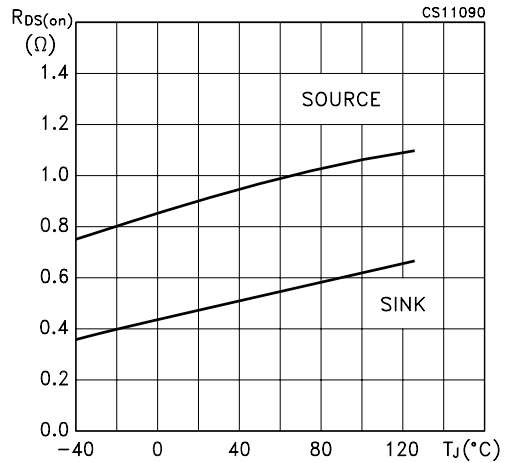


Figure 2 : Rise and Fall Time vs Load Capacitor

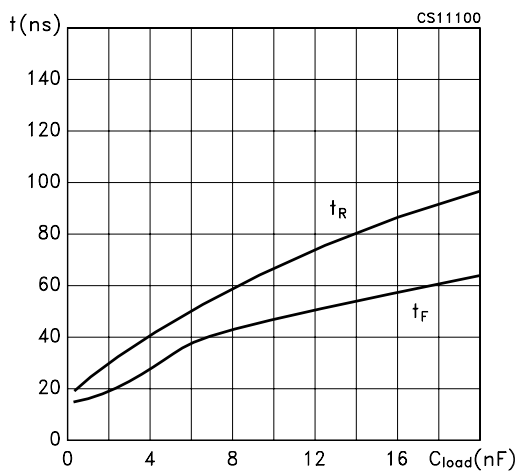


Figure 5 : Clock Threshold Voltage vs Temperature

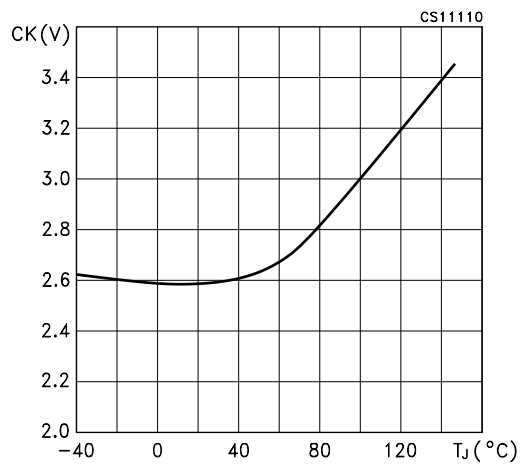


Figure 3 : OUT<sub>GATE1,2</sub> vs Characteristics

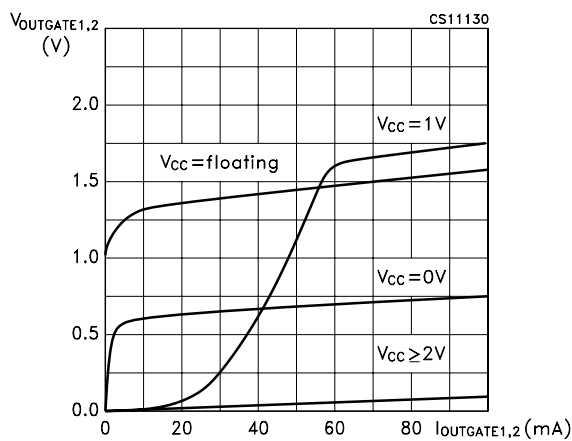
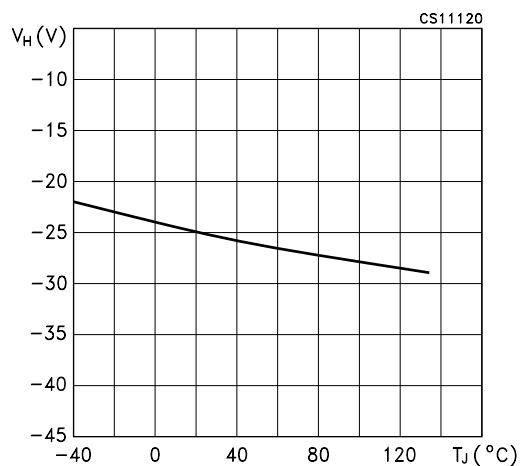
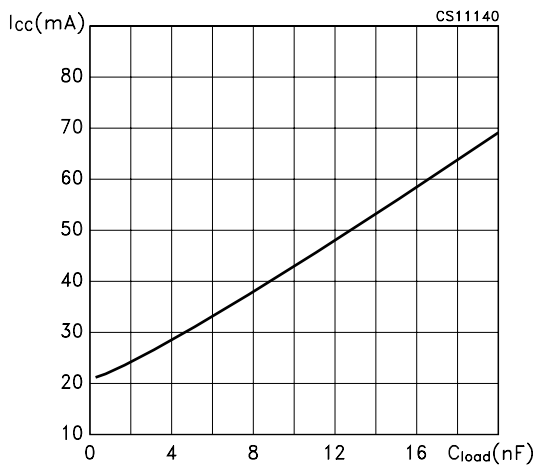


Figure 6 : INHIBIT Threshold Voltage vs Temperature

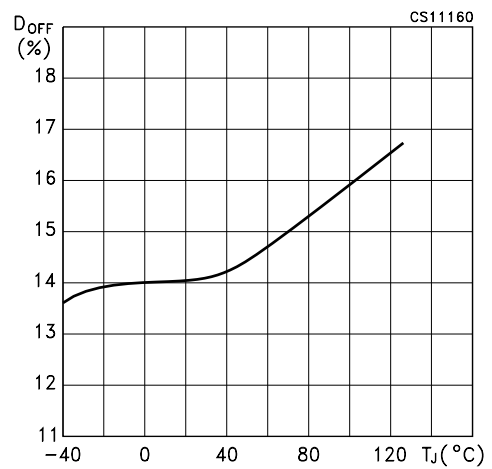




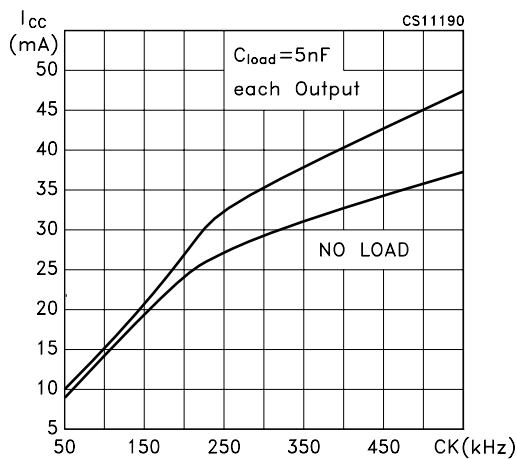
**Figure 7 : Supply Current vs Load Capacitor (each output)**



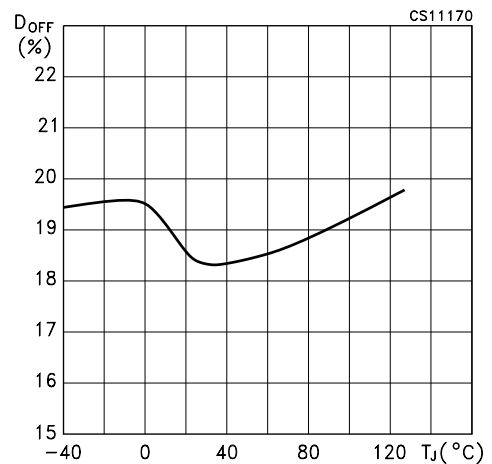
**Figure 10 : Duty Cycle Shut Down vs Temperature**



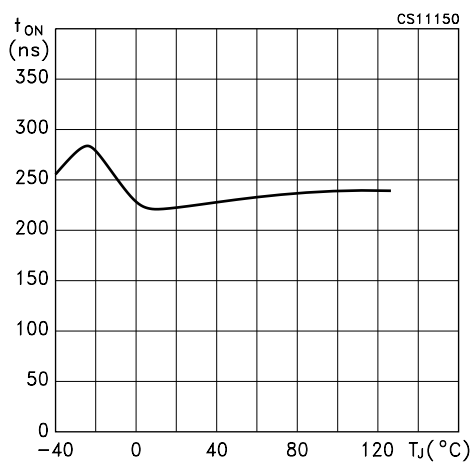
**Figure 8 : Supply Current vs Clock Frequency**



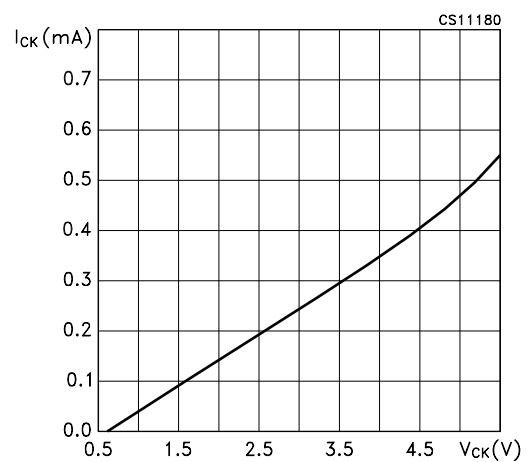
**Figure 11 : Duty Cycle Turn ON After Shut Down vs Temperature**



**Figure 9 : T<sub>ON</sub>(GATE2) vs Temperature**

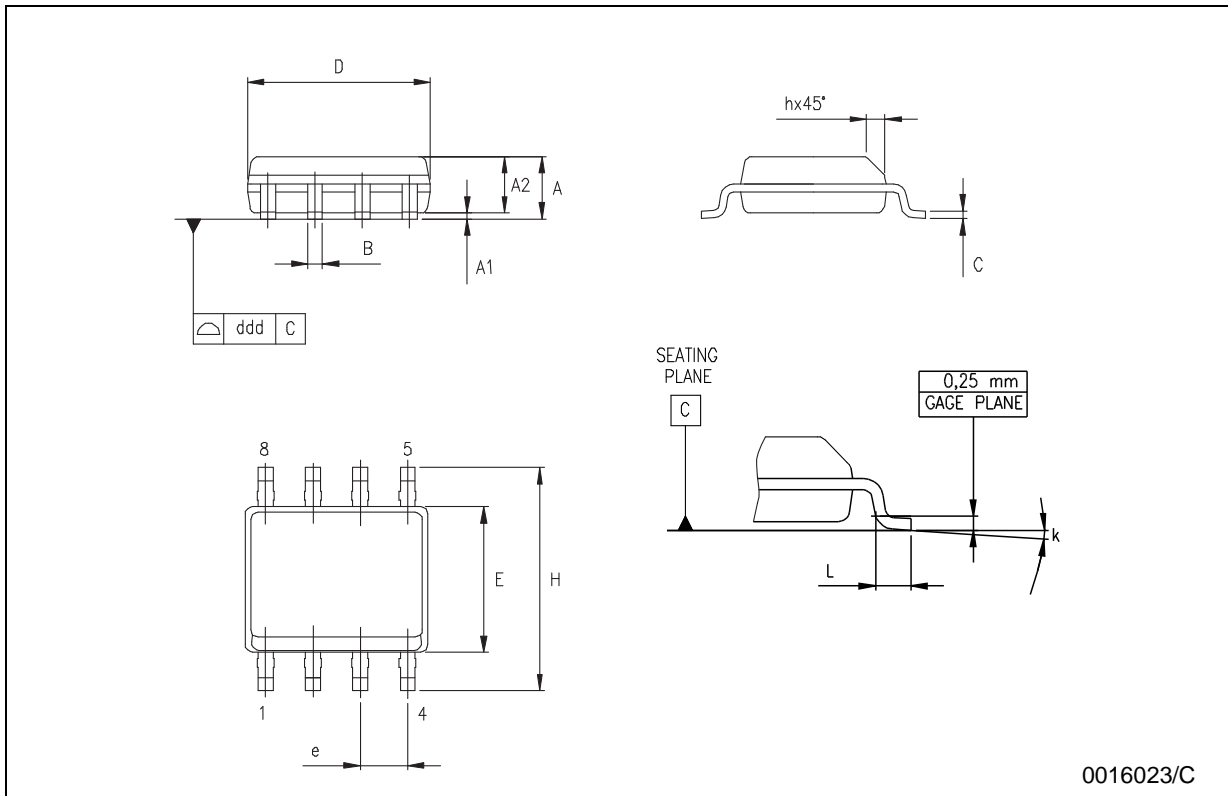


**Figure 12 : Clock Leakage Current vs Clock Voltage**



**SO-8 MECHANICAL DATA**

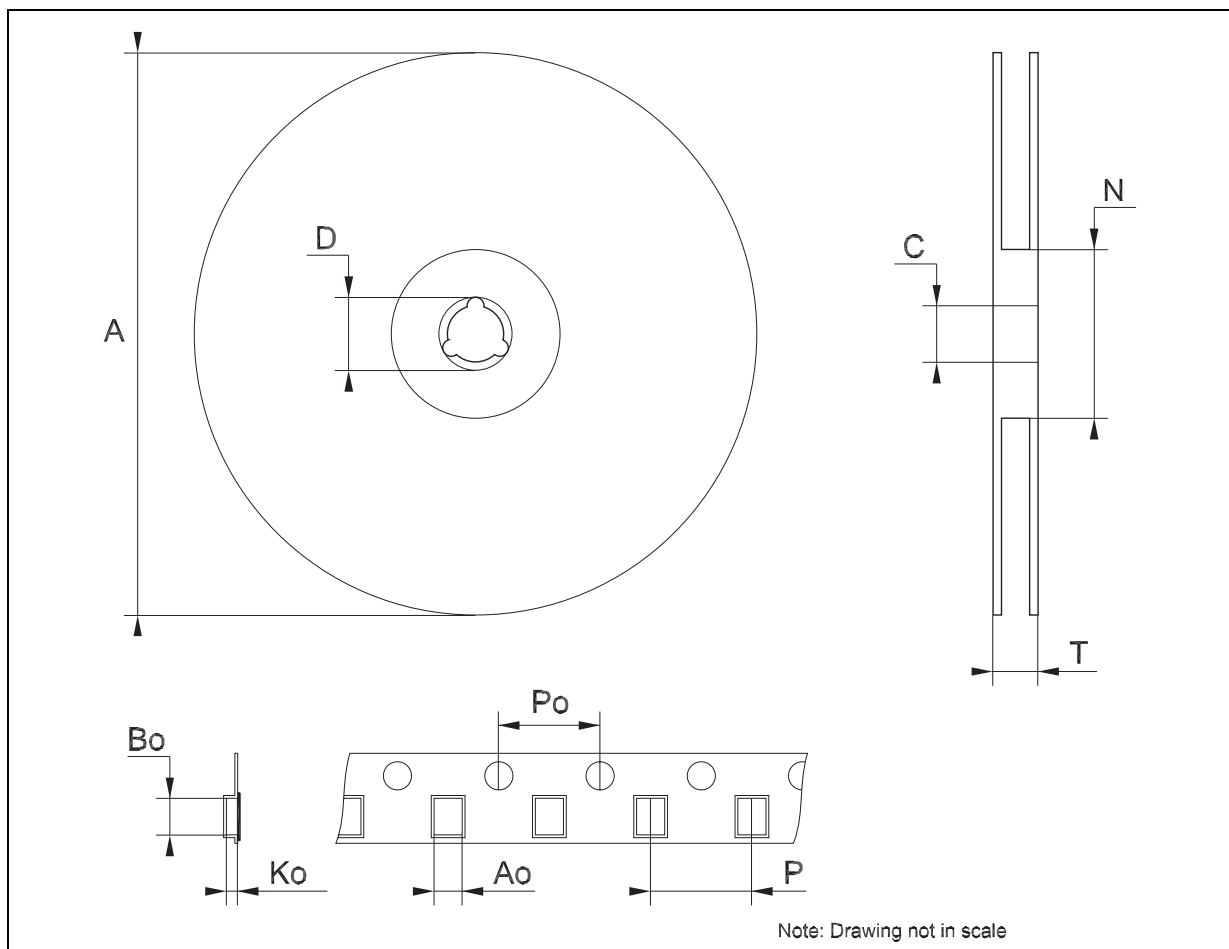
DIM.	mm.			inch		
	MIN.	TYP.	MAX.	MIN.	TYP.	MAX.
A	1.35		1.75	0.053		0.069
A1	0.10		0.25	0.04		0.010
A2	1.10		1.65	0.043		0.065
B	0.33		0.51	0.013		0.020
C	0.19		0.25	0.007		0.010
D	4.80		5.00	0.189		0.197
E	3.80		4.00	0.150		0.157
e		1.27			0.050	
H	5.80		6.20	0.228		0.244
h	0.25		0.50	0.010		0.020
L	0.40		1.27	0.016		0.050
k	8° (max.)					
ddd			0.1			0.04



0016023/C

## Tape &amp; Reel SO-8 MECHANICAL DATA

DIM.	mm.			inch		
	MIN.	TYP	MAX.	MIN.	TYP.	MAX.
A			330			12.992
C	12.8		13.2	0.504		0.519
D	20.2			0.795		
N	60			2.362		
T			22.4			0.882
Ao	8.1		8.5	0.319		0.335
Bo	5.5		5.9	0.216		0.232
Ko	2.1		2.3	0.082		0.090
Po	3.9		4.1	0.153		0.161
P	7.9		8.1	0.311		0.319



Information furnished is believed to be accurate and reliable. However, STMicroelectronics assumes no responsibility for the consequences of use of such information nor for any infringement of patents or other rights of third parties which may result from its use. No license is granted by implication or otherwise under any patent or patent rights of STMicroelectronics. Specifications mentioned in this publication are subject to change without notice. This publication supersedes and replaces all information previously supplied. STMicroelectronics products are not authorized for use as critical components in life support devices or systems without express written approval of STMicroelectronics.

The ST logo is a registered trademark of STMicroelectronics  
All other names are the property of their respective owners

© 2003 STMicroelectronics - All Rights Reserved  
STMicroelectronics GROUP OF COMPANIES

Australia - Belgium - Brazil - Canada - China - Czech Republic - Finland - France - Germany - Hong Kong - India - Israel - Italy - Japan -  
Malaysia - Malta - Morocco - Singapore - Spain - Sweden - Switzerland - United Kingdom - United States.

<http://www.st.com>