

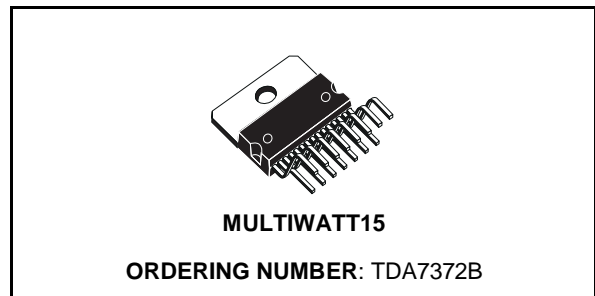

TDA7372B

4 x 6W POWER AMPLIFIER FOR CAR RADIO

- HIGH POWER CAPABILITY:
4x6W min/4Ω @14.4V, 1KHz, 10%
4x10W typ/2Ω @14.4V, 1KHz, 10%
- MINIMUM EXTERNAL COMPONENT COUNT
 - INTERNALLY FIXED GAIN (40dB)
 - NO BOOTSTRAP CAPACITORS
 - NO EXTERNAL COMPENSATION
- ST-BY FUNCTION (CMOS COMPATIBLE)
- MUTE FUNCTION (CMOS COMPATIBLE)
- NO AUDIBLE POP DURING MUTE/ST-BY OPERATIONS
- LOW SUPPLY SELF MUTING
- PROGRAMMABLE TURN ON DELAY



- FORTUITOUS OPEN GND
- REVERSE BATTERY
- ESD PROTECTION

PROTECTIONS:

- AC OUTPUT SHORT CIRCUIT TO GND
- DC OUTPUT SHORT CIRCUIT TO GND AND TO V_s AT POWER ON
- SOFT THERMAL LIMITER
- OVERRATING CHIP TEMPERATURE
- LOAD DUMP VOLTAGE

DESCRIPTION

The TDA7372B is a new technology class AB quad channels Audio Power Amplifier in Multiwatt15 package designed for car radio applications.

Thanks to the fully complementary PNP/NPN output configuration the TDA7372B delivers a rail to rail voltage swing with no need of bootstrap capacitors.

BLOCK DIAGRAM

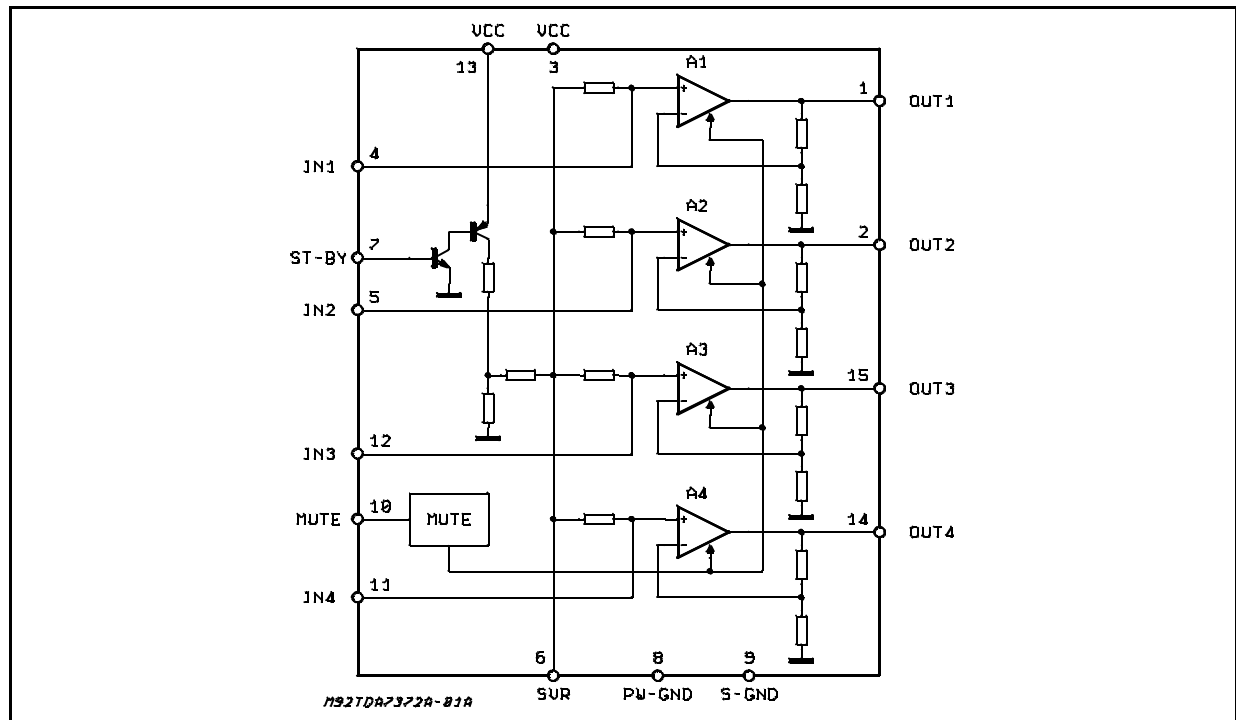

TDA7372B

PIN CONNECTION (Top view)

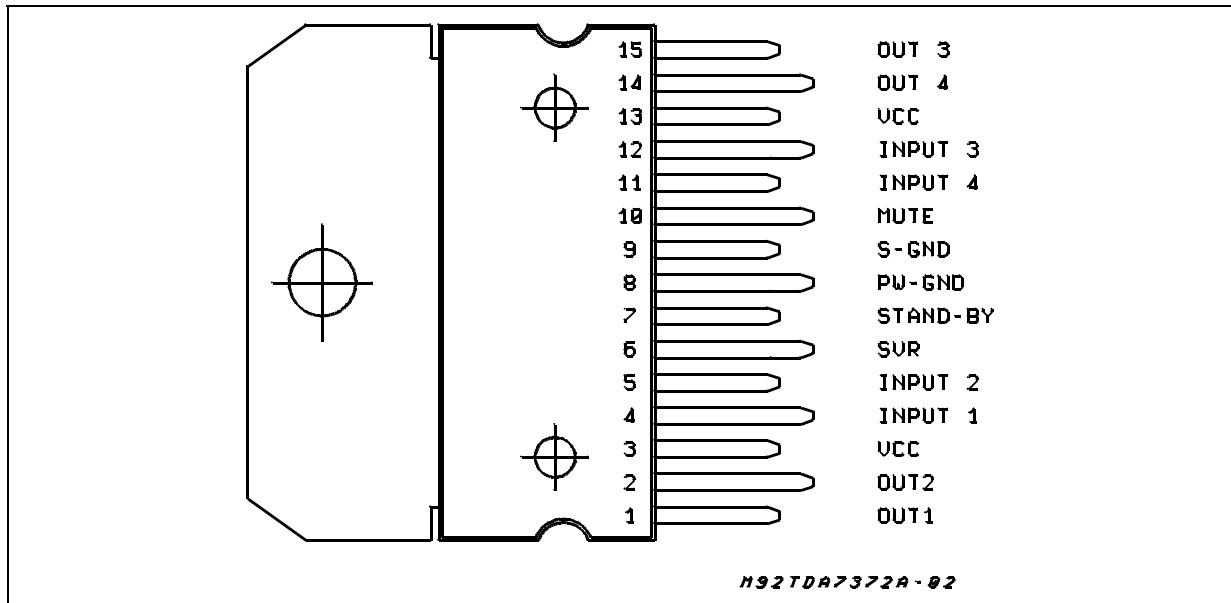

ABSOLUTE MAXIMUM RATINGS

Symbol	Parameter	Value	Unit
V_S	DC Supply Voltage	28	V
V_{OP}	Operating Supply Voltage	18	V
V_{PEAK}	Peak Supply Voltage ($t = 50\text{ms}$)	50	V
I_O	Output Peak Current (not rep. $t = 100\mu\text{s}$)	4	A
I_O	Output Peak Current (rep. $f > 10\text{Hz}$)	3	A
P_{tot}	Power Dissipation ($T_{case} = 85^\circ\text{C}$)	32	W
T_{stg}, T_j	Storage and Junction Temperature	-40 to 150	$^\circ\text{C}$

THERMAL DATA

Symbol	Description	Value	Unit
$R_{th\ j-case}$	Thermal Resistance Junction-case	Max 2	$^\circ\text{C}/\text{W}$

ELECTRICAL CHARACTERISTICS (Refer to the test circuit; $V_S = 14.4V$; $R_L = 4\Omega$, $T_{amb} = 25^\circ C$, $f = 1kHz$, unless otherwise specified)

Symbol	Parameter	Test Condition	Min.	Typ.	Max.	Unit
V_S	Supply Range		8		18	V
I_d	Total Quiescent Drain Current				150	mA
P_O	Output Power	$R_L = 4\Omega$; THD = 10% each channel	6	6.5		W
		$R_L = 2\Omega$; THD = 10% each channel		10		W
d	Distortion	$R_L = 4\Omega$; $P_O = 0.1$ to $3W$		0.08	0.5	%
CT	Cross Talk	$f = 1kHz$; $R_g = 0$ $f = 10kHz$; $R_g = 0$	45	50 40		dB dB
R_{IN}	Input Impedance		35			K Ω
G_V	Voltage Gain			40		dB
G_V	Voltage Gain Match.				1	dB
BW	Bandwidth	@ -3dB	75			KHz
E_{NO}	Output Noise Voltage (*)	$R_g = 0$			300	μV
SVR	Supply Voltage Rejection	$R_g = 0$; $f = 100Hz$	45			dB
ASB	Stand-by Attenuation		80			dB
I_{SB}	ST-BY Current Consumption	$V_{pin7} = 1.5V$			100	μA
$I_{PIN 7}$	ST-BY Pin Current	Play mode; $V_{pin7} = 5V$			50	μA
		Output Under Short (Max driving current under fault)			5	mA
$V_{SB IN}$	ST-BY IN Threshold Voltage				1.5	V
$V_{SB OUT}$	ST-BY OUT Threshold Voltage		3.5			V
A_M	MUTE Attenuation			80		dB
$V_{M IN}$	MUTE IN Threshold Voltage				1.5	V
$V_{M OUT}$	MUTE OUT Threshold Voltage		3.5			V

(*) 22Hz to 22KHz

TEST AND APPLICATION CIRCUIT

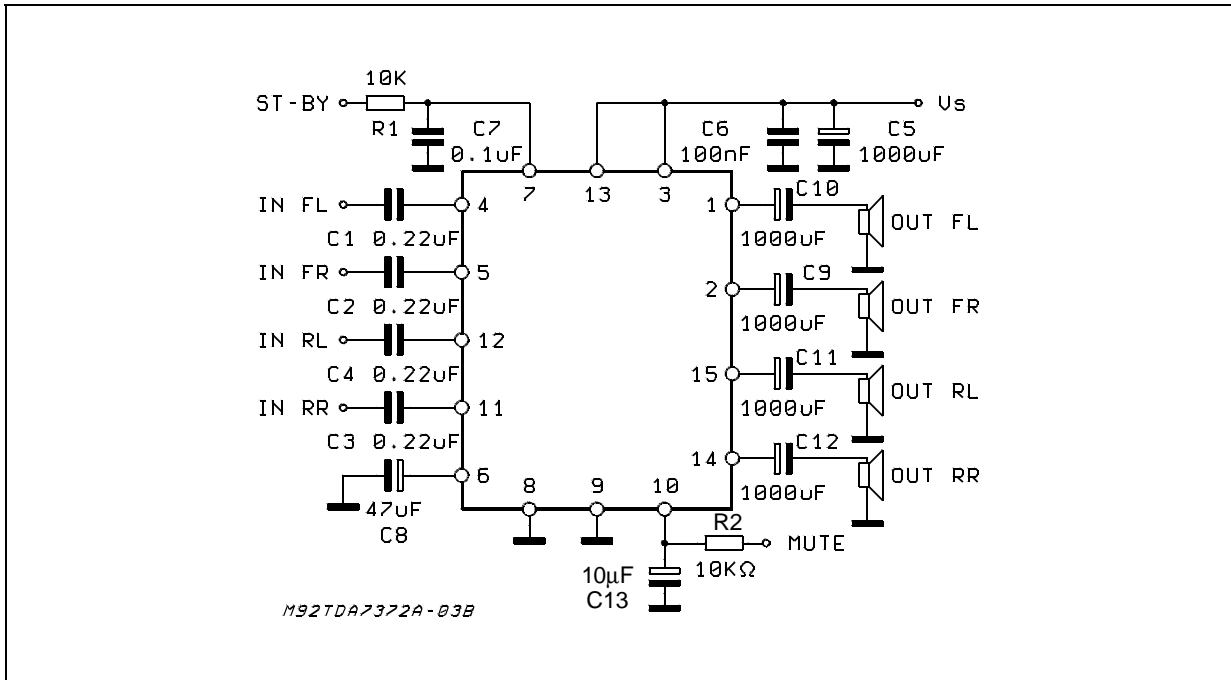

If high source resistance is present (e.g. passive audio controls) it might be necessary to add $C = 470\text{pF}$ from each input pin to S-GND to prevent instability phenomena.

Figure 1: P.C. Board and components layout of the Test and Application Circuit (1:1 scale)

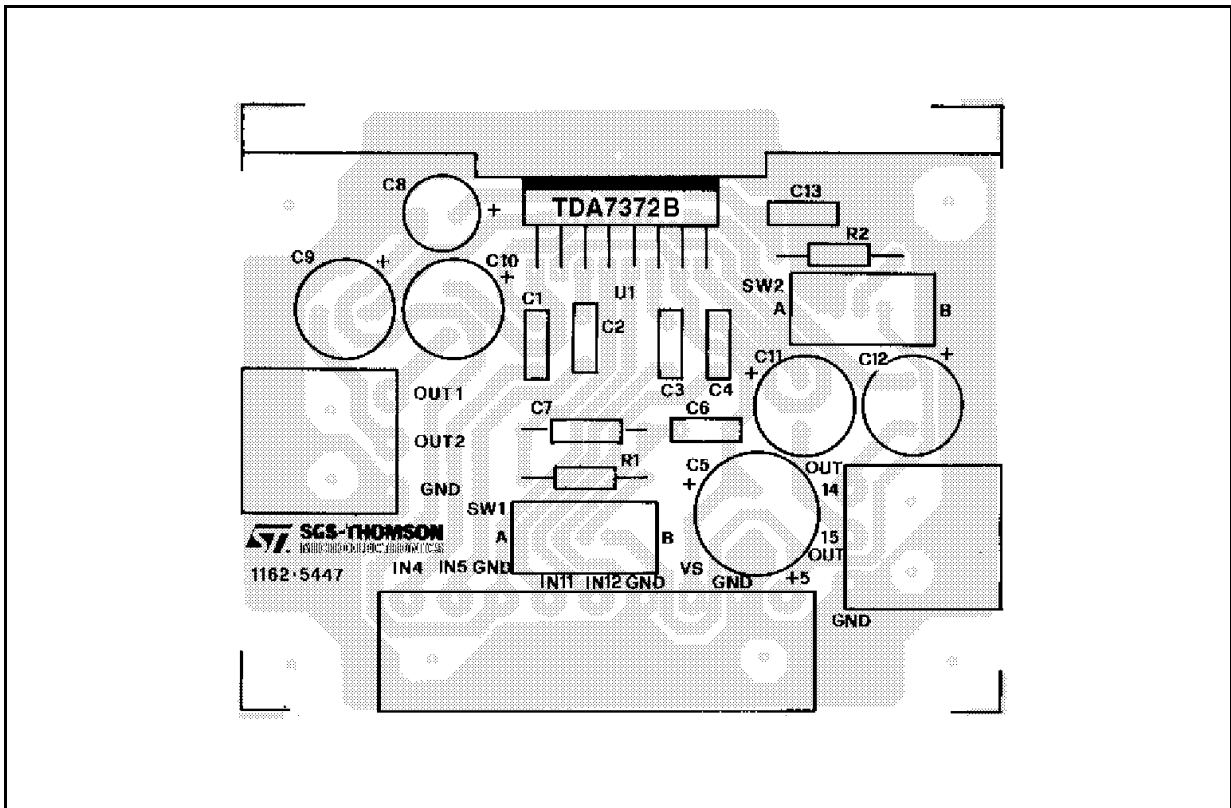

Figure 2: Quiescent Drain Current vs. Supply Voltage

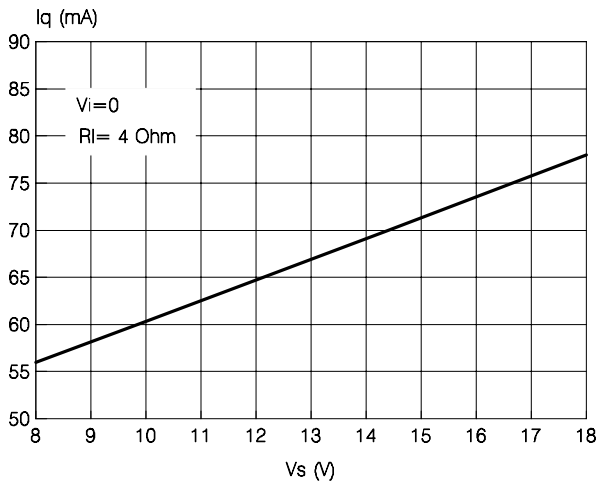

Figure 3: Output Power vs. Supply Voltage

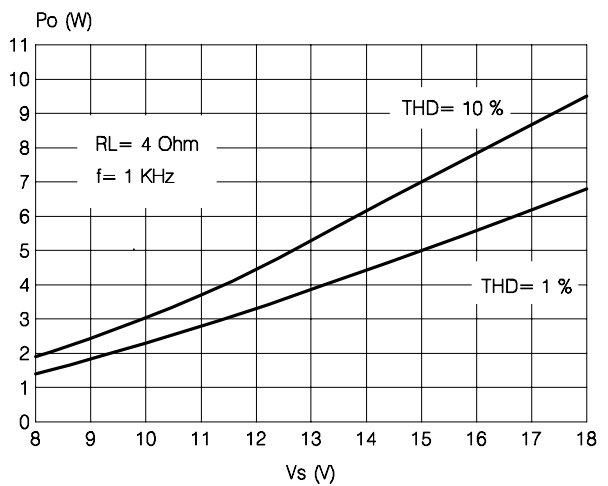

Figure 4: Output Power vs Supply Voltage

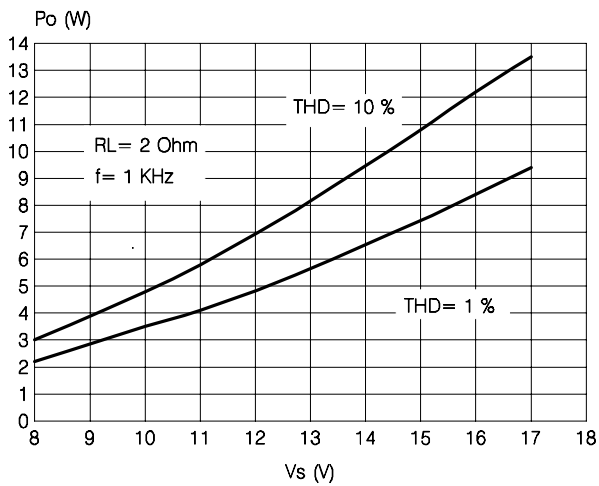

Figure 5: Output power vs. Frequency vs. C_{OUT} Value

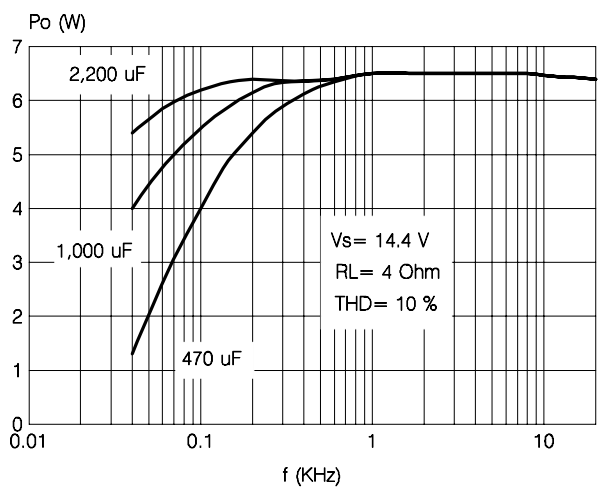

Figure 6: Distortion vs. Output Power

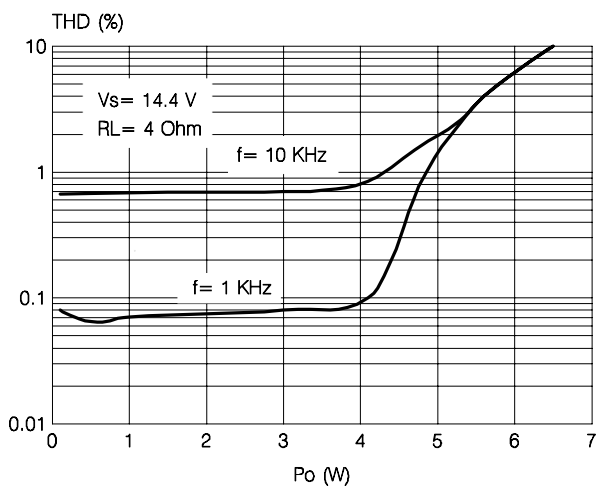

Figure 7: Distortion vs. Output Power

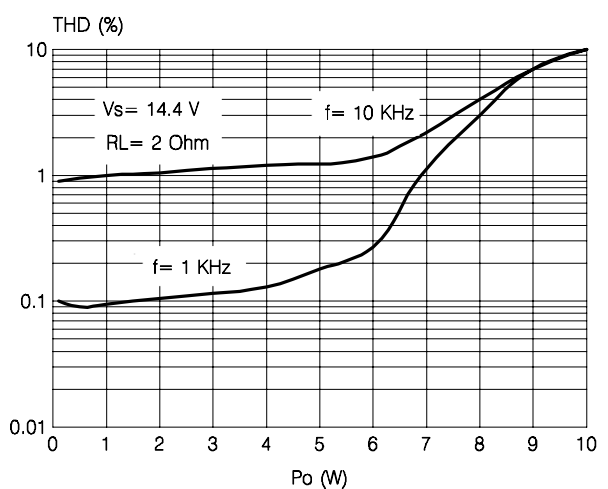

Figure 8: Distortion vs. Frequency

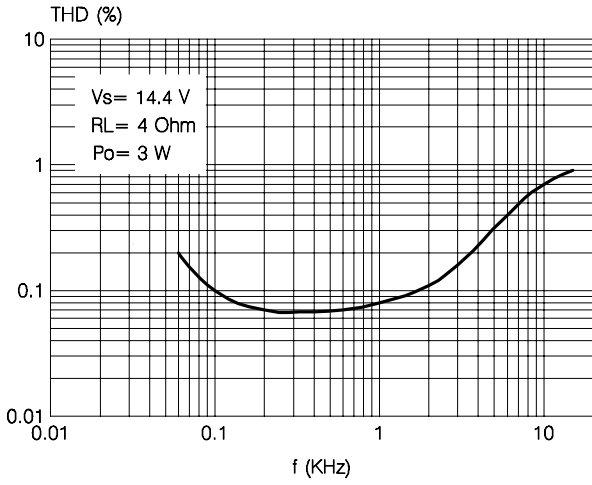

Figure 9: Distortion vs. Frequency

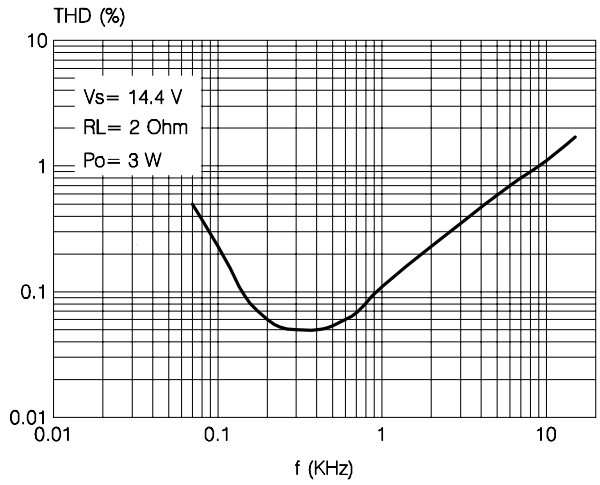

Figure 10: Cross-Talk vs. Frequency

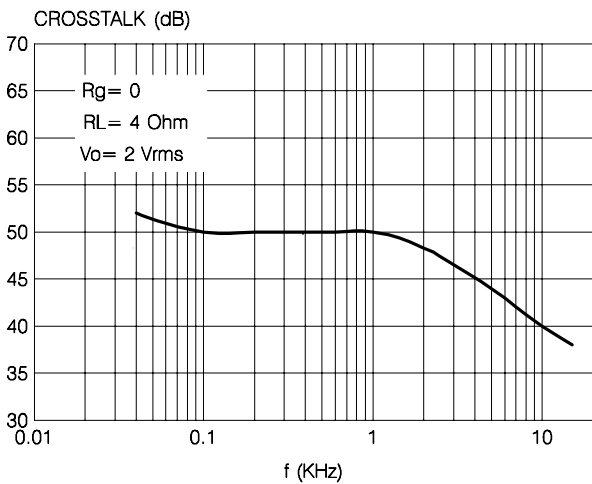

Figure 11: Supply Voltage Rejection vs. Frequency

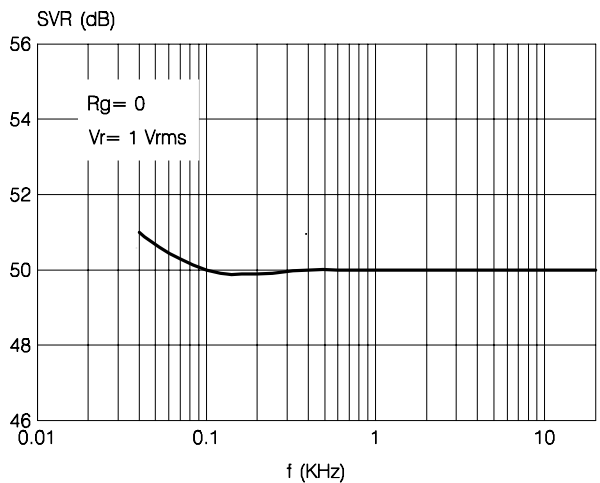

Figure 12: Total Power Dissipation and Efficiency

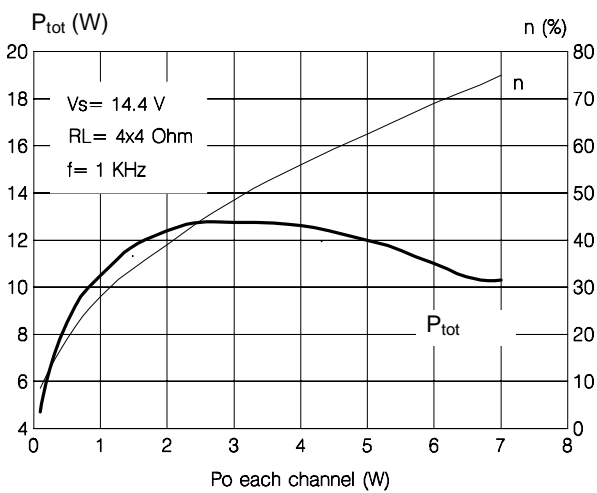

Figure 13: Total Power Dissipation and Efficiency vs. Output Power

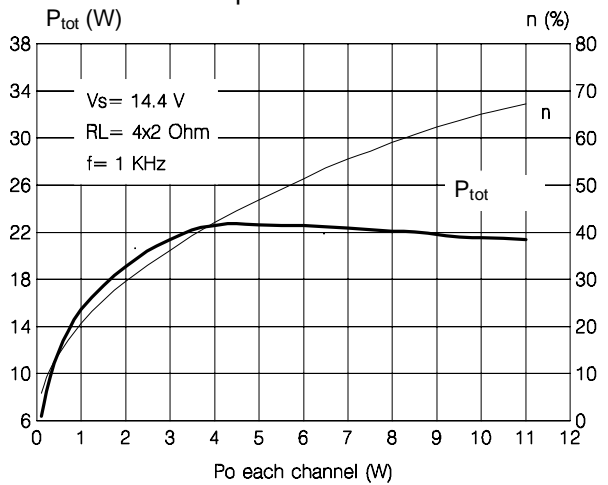
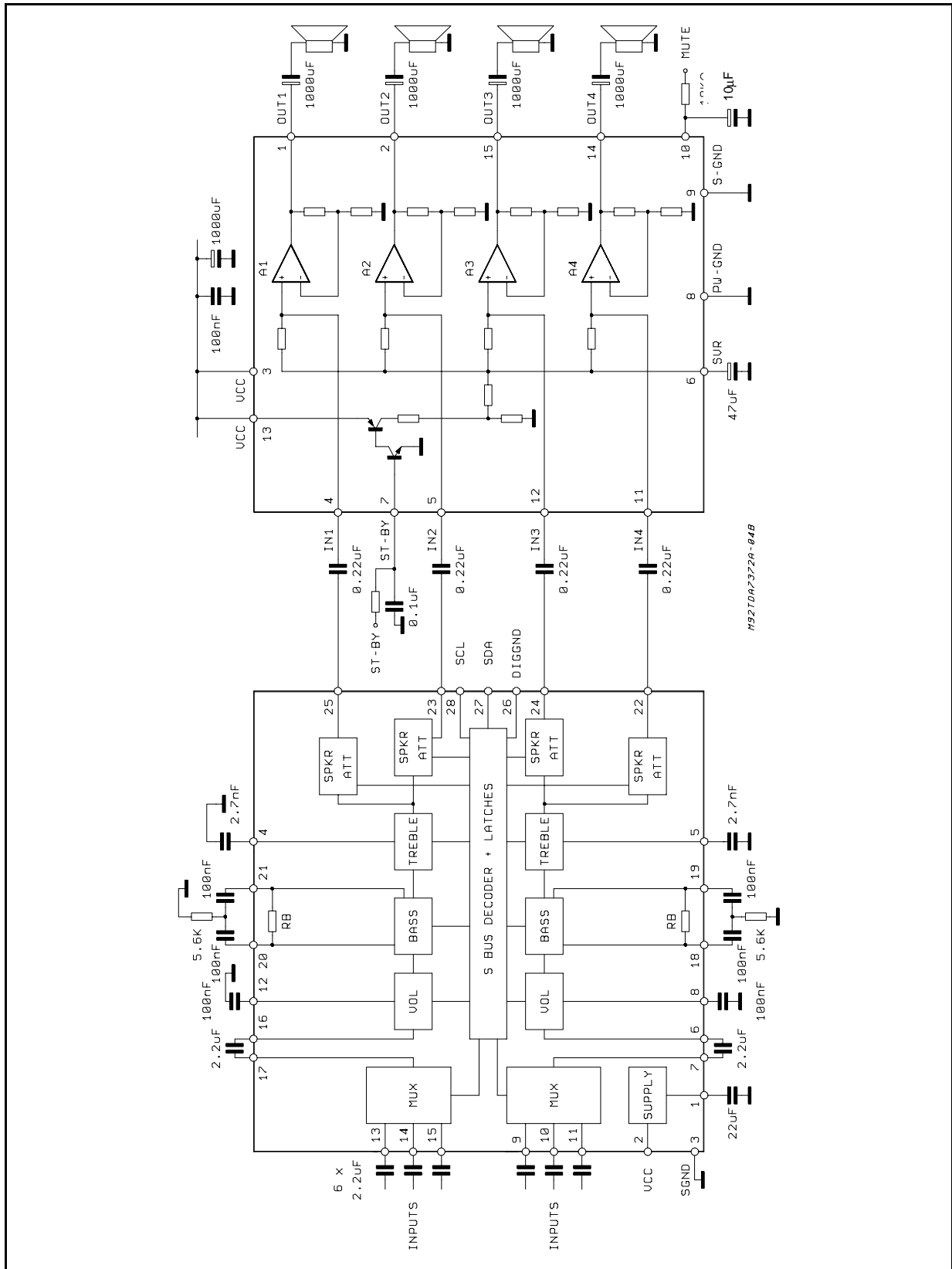

Figure 14: TDA7317 + 7372 Application Circuit.



FUNCTIONAL DESCRIPTION

Function	Description
GENERAL	The TDA7372B is a quad channel single package audio power amplifier intended to reduce the mismatch in the electrical characteristics among the four different channels and to consistently drop the external component count. It contains four non inverting stages whose gain is internally fixed to 40dB.
OUTPUT STAGE	The output stage is a single ended type suitable to drive 4Ω loads. It consists of a class AB fully complementary PNP/NPN stages short circuit protected. A rail to rail output swing is achieved without need of bootstrap capacitors. Moreover, the external compensation is not necessary.
ST-BY	The device features a St-BY function which shuts down the internal bias supplies when the ST-BY input is low. In ST-BY mode the amplifier sinks a small current (in the range of few μAs). When the St-BY pin is high the IC becomes fully operational.
MUTE	A mute function is also provided. This reduces the gain of the input stage to a level effectively eliminating any audio input influence on the output stage when the mute line is low. When the mute line is high the normal input path is restored. The device goes automatically is mute status when the supply voltage goes below the minimum allowed value. This prevents pop noises whenever the battery voltage drops below a fixed threshold. When the supply voltage rises to its nominal value the device recovers the play condition with a delay fixed by the C _{SVR} capacitor.
THERMAL PROTECTION	The Thermal protection principle involves two different steps a) Soft thermal limitation b) Shutdown Until the junction temperature remains below a preset threshold, the I.C. will deliver the full power. Once the threshold has been reached, the device automatically goes, into mute status. The play to mute transition is internally controlled so producing a soft muting without unpleasant effect. Supposing the junction temperature does not reduce to safe levels a complete shutdown will occur.
BUILT-IN SHORT CIRCUIT PROTECTION	Reliable and safe operation in presence of: - AC short circuit to GND - DC short circuit to GND and to V _S during power-on phase is assured by a built-in protection circuitry. the DC short protector acts in such a way to avoid the device is turned on (by ST-BY) when a DC short is present between out to GND or out to V _S . Due to this reason it is necessary to introduce a proper delay on the st-by pin (especially when it is driven by V _S) More over, as the involved circuitry is normally disabled when a current higher than 5mA is flowing into the st-by pin, it is important, in order not to disable it, to have the external current source driving the pin it self limited to 5mA. (figure 1 is showing relevant waveforms).

Figure 15: Fault (DC short) waveforms

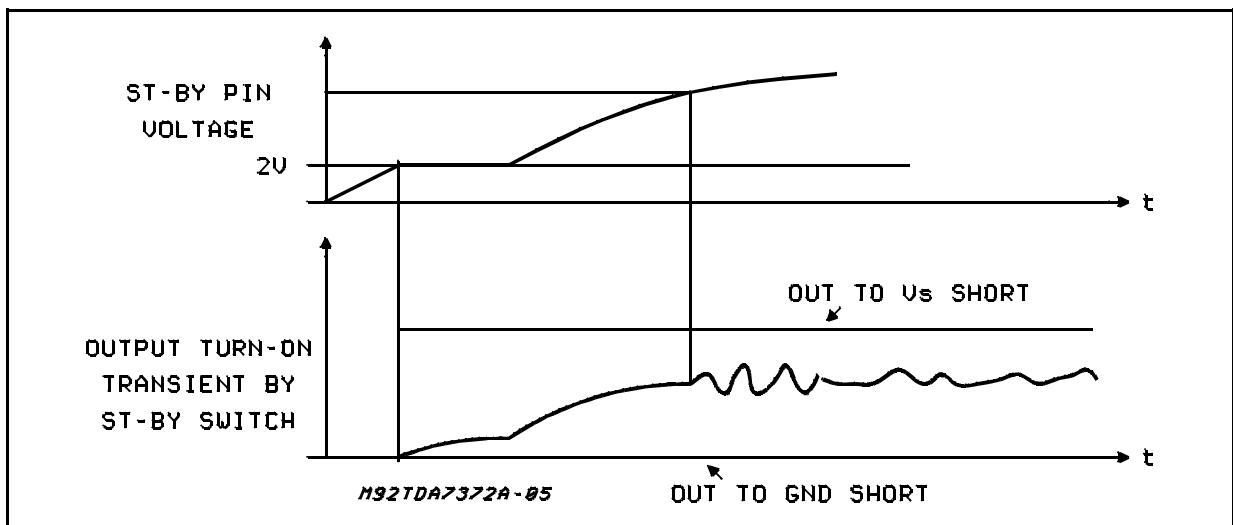

DIM.	mm			inch		
	MIN.	TYP.	MAX.	MIN.	TYP.	MAX.
A			5			0.197
B			2.65			0.104
C			1.6			0.063
D		1			0.039	
E	0.49		0.55	0.019		0.022
F	0.66		0.75	0.026		0.030
G	1.02	1.27	1.52	0.040	0.050	0.060
G1	17.53	17.78	18.03	0.690	0.700	0.710
H1	19.6			0.772		
H2			20.2			0.795
L	21.9	22.2	22.5	0.862	0.874	0.886
L1	21.7	22.1	22.5	0.854	0.870	0.886
L2	17.65		18.1	0.695		0.713
L3	17.25	17.5	17.75	0.679	0.689	0.699
L4	10.3	10.7	10.9	0.406	0.421	0.429
L7	2.65		2.9	0.104		0.114
M	4.25	4.55	4.85	0.167	0.179	0.191
M1	4.63	5.08	5.53	0.182	0.200	0.218
S	1.9		2.6	0.075		0.102
S1	1.9		2.6	0.075		0.102
Dia1	3.65		3.85	0.144		0.152

OUTLINE AND MECHANICAL DATA

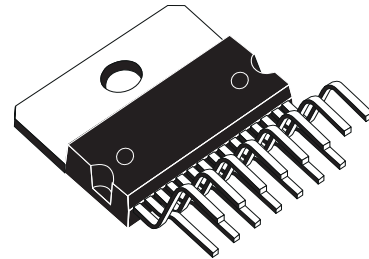

Multiwatt15 V

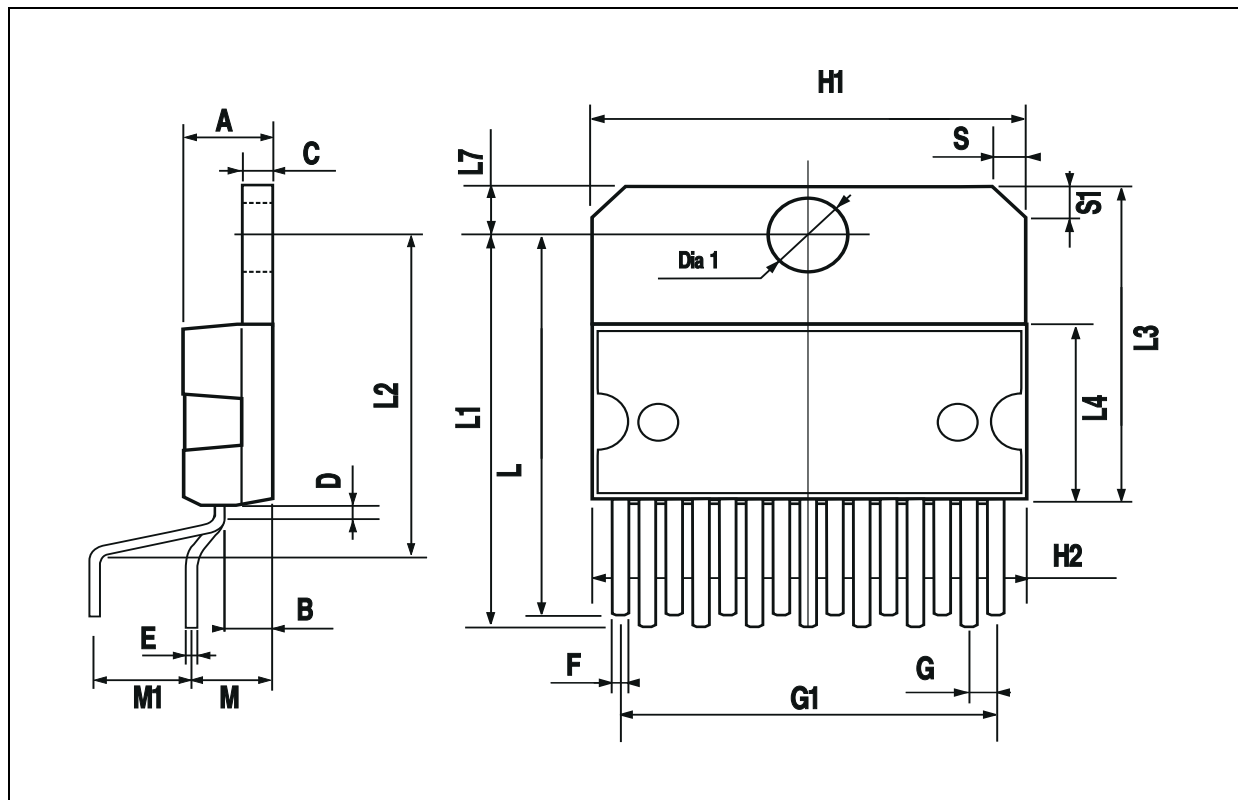

Information furnished is believed to be accurate and reliable. However, STMicroelectronics assumes no responsibility for the consequences of use of such information nor for any infringement of patents or other rights of third parties which may result from its use. No license is granted by implication or otherwise under any patent or patent rights of STMicroelectronics. Specifications mentioned in this publication are subject to change without notice. This publication supersedes and replaces all information previously supplied. STMicroelectronics products are not authorized for use as critical components in life support devices or systems without express written approval of STMicroelectronics.

The ST logo is a registered trademark of STMicroelectronics.
All other names are the property of their respective owners

© 2003 STMicroelectronics - All rights reserved

STMicroelectronics GROUP OF COMPANIES

Australia – Belgium - Brazil - Canada - China – Czech Republic - Finland - France - Germany - Hong Kong - India - Israel - Italy - Japan -
Malaysia - Malta - Morocco - Singapore - Spain - Sweden - Switzerland - United Kingdom - United States

www.st.com