

Sensitive gate 4 A SCRs

Features

- On-state rms current, 4 A
- Repetitive peak off-state voltages, 600 and 700 V
- Triggering gate current, 0.2 mA

Description

Thanks to highly sensitive triggering levels, the TS420 series is suitable for all applications where the available gate current is limited, such as motor control for hand tools, kitchen aids, overvoltage crowbar protection for low power supplies among others.

Available in through-hole or surface-mount packages, they provide an optimized performance in a limited space area.

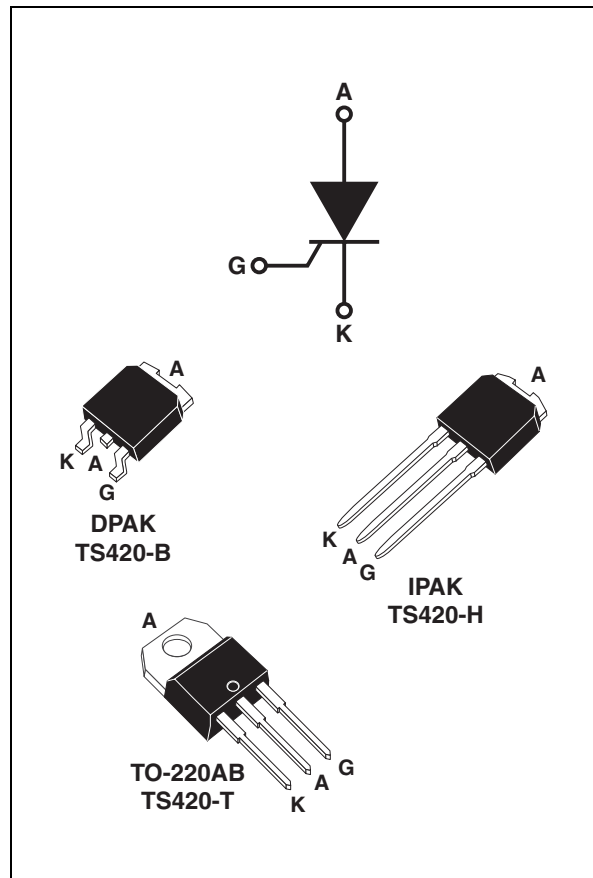

Table 1. Device summary

Order code	Voltage (xxx)		Sensitivity	Package
	600 V	700 V		
TS420-xxxB	X	X	0.2 mA	DPAK
TS420-xxxH	X	X	0.2 mA	IPAK
TS420-xxxT	X	X	0.2 mA	TO-220AB

1 Characteristics

Table 2. Absolute ratings (limiting values)

Symbol	Parameter		Value	Unit
$I_{T(RMS)}$	On-state rms current (180° conduction angle)		$T_I = 115\text{ °C}$	A
$I_{T(AV)}$	Average on-state current (180° conduction angle)		$T_I = 115\text{ °C}$	A
I_{TSM}	Non repetitive surge peak on-state current	$t_p = 8.3\text{ ms}$	$T_j = 25\text{ °C}$	33
		$t_p = 10\text{ ms}$		30
I^2t	I^2t Value for fusing	$t_p = 10\text{ ms}$	$T_j = 25\text{ °C}$	A^2s
di/dt	Critical rate of rise of on-state current $I_G = 2 \times I_{GT}, t_r \leq 100\text{ ns}$	$F = 60\text{ Hz}$	$T_j = 125\text{ °C}$	$A/\mu s$
I_{GM}	Peak gate current	$t_p = 20\text{ }\mu s$	$T_j = 125\text{ °C}$	A
$P_{G(AV)}$	Average gate power dissipation		$T_j = 125\text{ °C}$	W
T_{stg}	Storage junction temperature range		- 40 to + 150	°C
T_j	Operating junction temperature range		- 40 to + 125	
V_{RGM}	Maximum peak reverse gate voltage		5	V

Table 3. Device timings

Symbol	Parameter	Test conditions	Value	Unit
t_{GT}	Gate controlled turn on time	$I_{TM} = 10\text{ A}, V_D = V_{DRM(max)}, I_{GT} = 10\text{ mA}, di_G/dt = 0.2\text{ A}/\mu s, R_G = 1\text{ k}\Omega, T_j = 25\text{ °C}$	0.5 (Typ.)	μs
t_Q	Circuit controlled turn off time	$V_D = 67\% V_{DRM(max)}, T_j = 125\text{ °C}, I_{TM} = 8\text{ A}, V_R = 10\text{ V}, di_T/dt = 10\text{ A}/\mu s, dV_D/dt = 2\text{ V}/\mu s, R_G = 1\text{ k}\Omega$	60 (Typ.)	

Table 4. Electrical characteristics ($T_j = 25\text{ °C}$, unless otherwise specified)

Symbol	Test conditions		Value	Unit		
I_{GT}	$V_D = 12\text{ V}$, $R_L = 33\ \Omega$	MAX.	200	μA		
V_{GT}		MAX.	0.8	V		
V_{GD}	$V_D = V_{DRM}$, $R_L = 33\ \text{k}\Omega$, $R_{GK} = 220\ \Omega$	$T_j = 125\text{ °C}$	MIN.	0.1	V	
V_{RG}	$I_{RG} = 10\ \mu\text{A}$		MIN.	8	V	
I_H	$I_T = 50\ \text{mA}$, $R_{GK} = 1\ \text{k}\Omega$		MAX.	5	mA	
I_L	$I_G = 1\ \text{mA}$, $R_{GK} = 1\ \text{k}\Omega$		MAX.	6	mA	
dV/dt	$V_D = 67\% V_{DRM}$, $R_{GK} = 220\ \Omega$	$T_j = 125\text{ °C}$	MIN.	5	V/ μs	
V_{TM}	$I_{TM} = 8\ \text{A}$, $t_p = 380\ \mu\text{s}$	$T_j = 25\text{ °C}$	MAX.	1.6	V	
V_{t0}	Threshold voltage		$T_j = 125\text{ °C}$	MAX.	0.85	V
R_d	Dynamic resistance		$T_j = 125\text{ °C}$	MAX.	90	m Ω
I_{DRM} I_{RRM}	$V_{DRM} = V_{RRM}$, $R_{GK} = 220\ \Omega$	$T_j = 25\text{ °C}$	MAX.	5	μA	
		$T_j = 125\text{ °C}$		1	mA	

Table 5. Thermal resistance

Symbol	Parameter		Value	Unit	
$R_{th(j-c)}$	Junction to case (DC)		3.0	$^{\circ}\text{C}/\text{W}$	
$R_{th(j-a)}$	Junction to ambient (DC)	$S^{(1)} = 0.5\ \text{cm}^2$	DPAK	70	$^{\circ}\text{C}/\text{W}$
			IPAK	100	
			TO-220AB	60	

1. Copper under surface tab

Figure 1. Maximum average power dissipation versus average on-state current

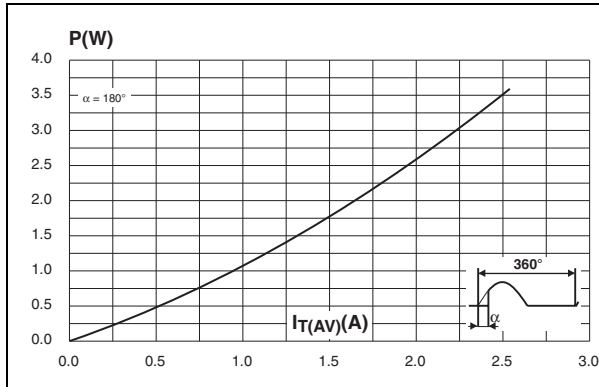

Figure 2. Average and DC on-state current versus case temperature

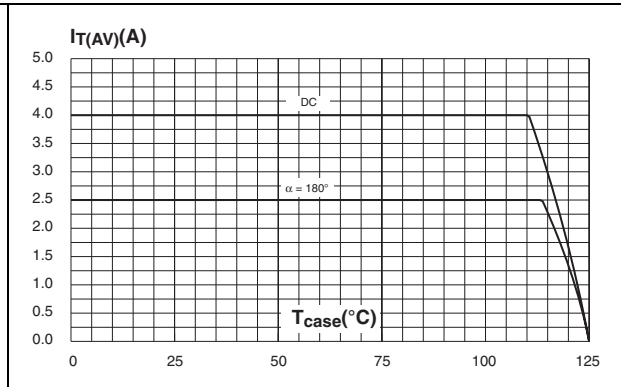

Figure 3. Average and DC on-state current versus ambient temperature (DPAK)

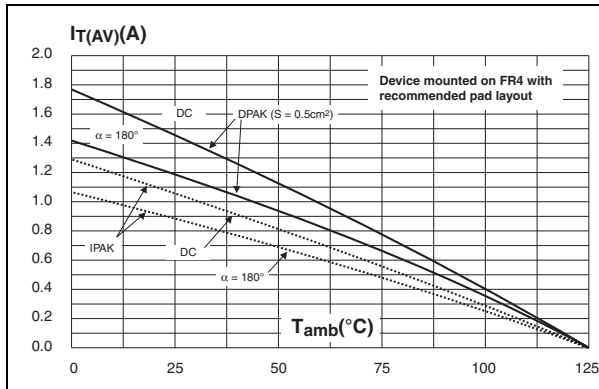

Figure 4. Relative variation of thermal impedance junction to ambient versus pulse duration (DPAK)

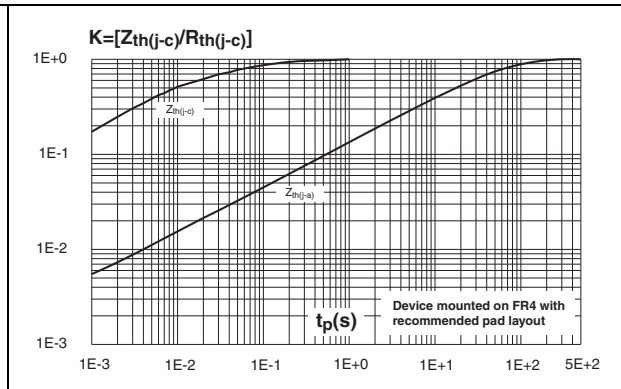

Figure 5. Relative variation of gate trigger current and holding current versus junction temperature

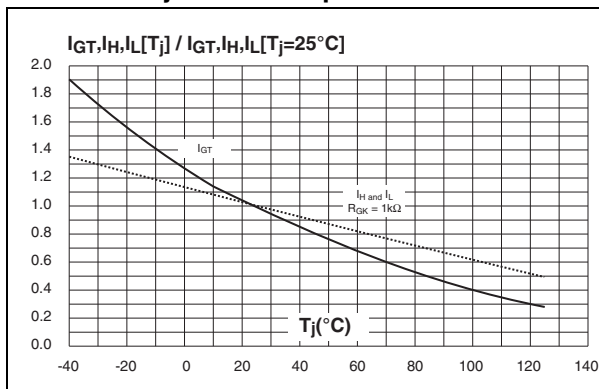

Figure 6. Relative variation of holding current versus gate-cathode resistance (typical values)

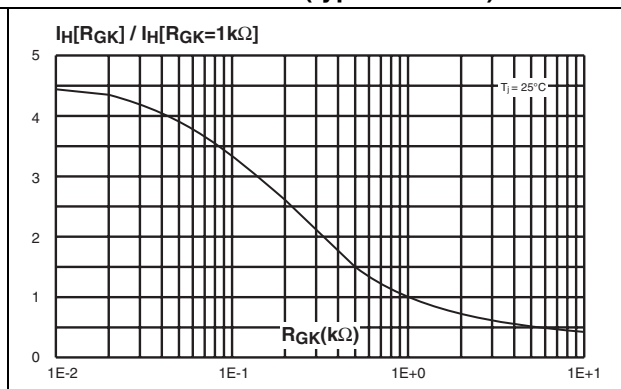

Figure 7. Relative variation of dV/dt immunity versus gate-cathode resistance (typical values)

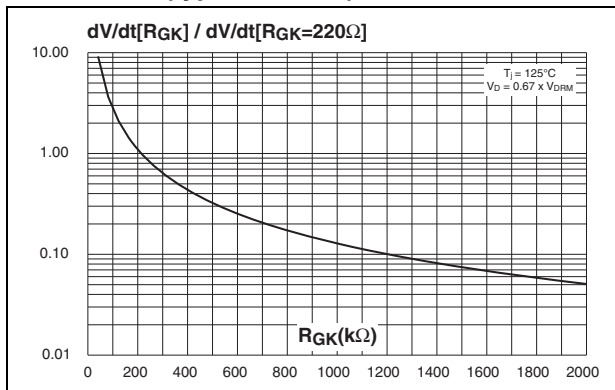

Figure 8. Relative variation of dV/dt immunity versus gate-cathode capacitance (typical values)

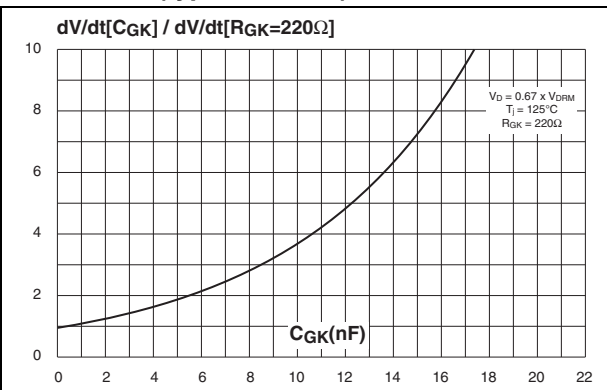

Figure 9. Surge peak on-state current versus number of cycles

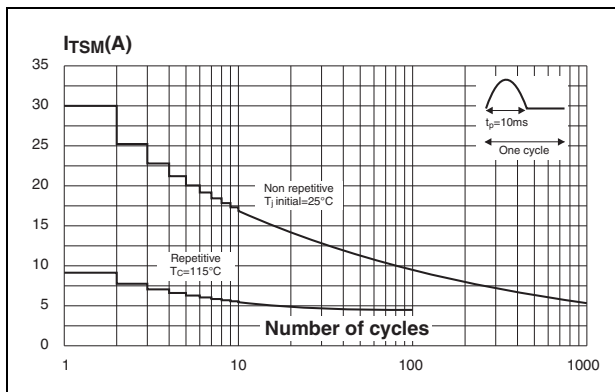

Figure 10. Non-repetitive surge peak on-state current, and corresponding values of I²t

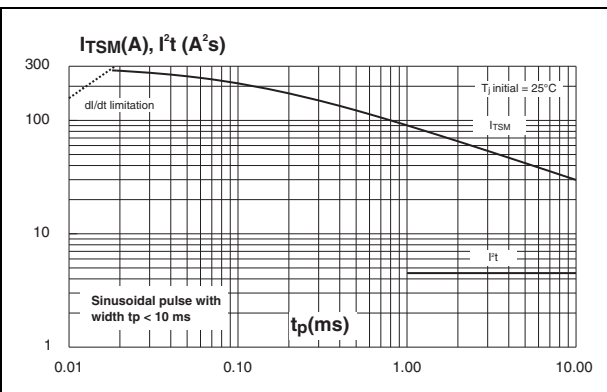

Figure 11. On-state characteristics (maximum values)

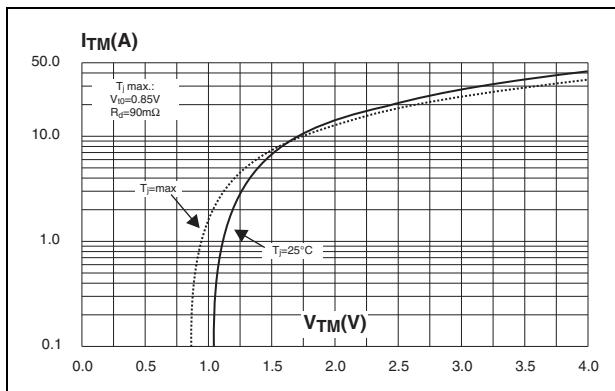
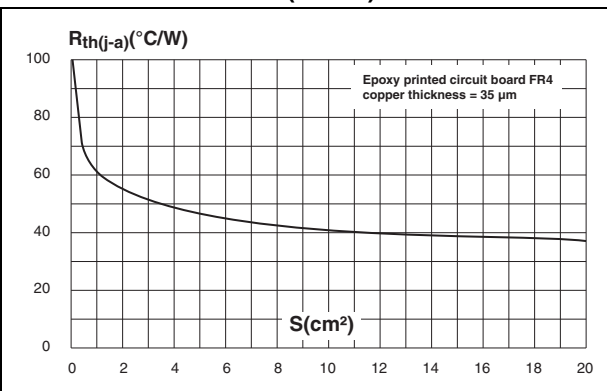
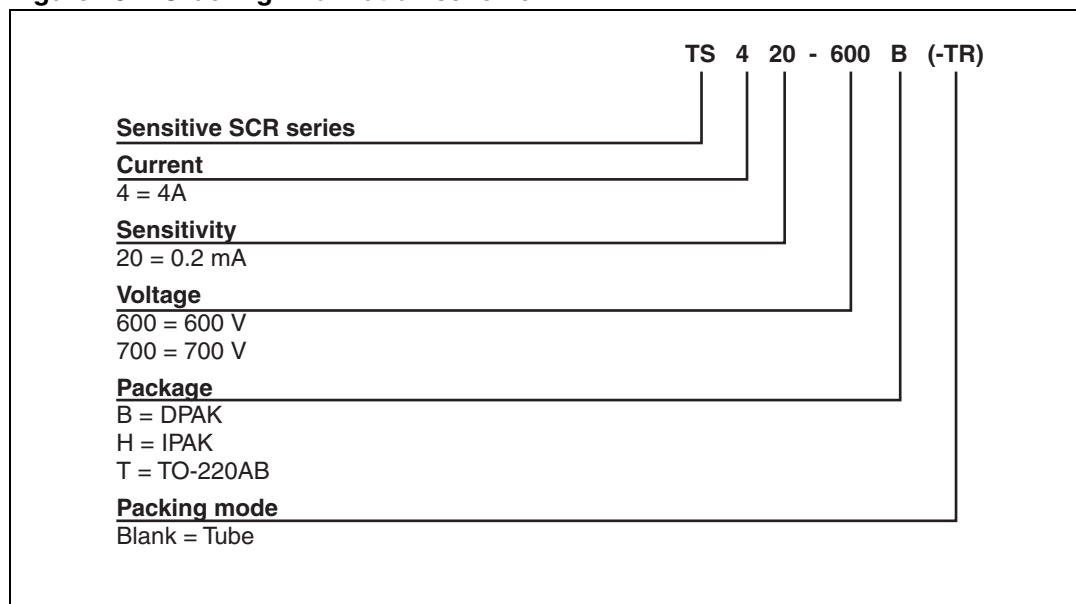

Figure 12. Thermal resistance junction to ambient versus copper surface under tab (DPAK)



2 Ordering information scheme

Figure 13. Ordering information scheme



3 Package information

- Epoxy meets UL94, V0
- Recommended torque 0.4 to 0.6 N·m (TO-220AB)

In order to meet environmental requirements, ST offers these devices in different grades of ECOPACK® packages, depending on their level of environmental compliance. ECOPACK® specifications, grade definitions and product status are available at: www.st.com. ECOPACK® is an ST trademark.

Table 6. DPAK dimensions

Ref.	Dimensions			
	Millimeters		Inches	
	Min.	Max.	Min.	Max.
A	2.20	2.40	0.086	0.094
A1	0.90	1.10	0.035	0.043
A2	0.03	0.23	0.001	0.009
B	0.64	0.90	0.025	0.035
B2	5.20	5.40	0.204	0.212
C	0.45	0.60	0.017	0.023
C2	0.48	0.60	0.018	0.023
D	6.00	6.20	0.236	0.244
E	6.40	6.60	0.251	0.259
G	4.40	4.60	0.173	0.181
H	9.35	10.10	0.368	0.397
L2	0.80 typ.		0.031 typ.	
L4	0.60	1.00	0.023	0.039
V2	0°	8°	0°	8°

Figure 14. Footprint (dimensions in mm)

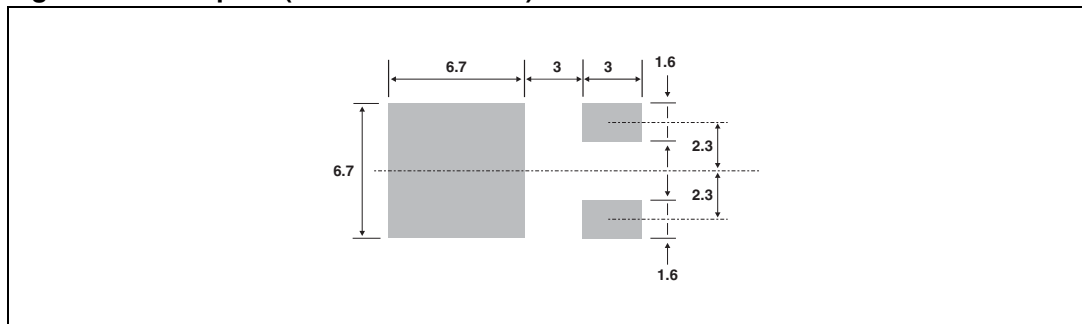
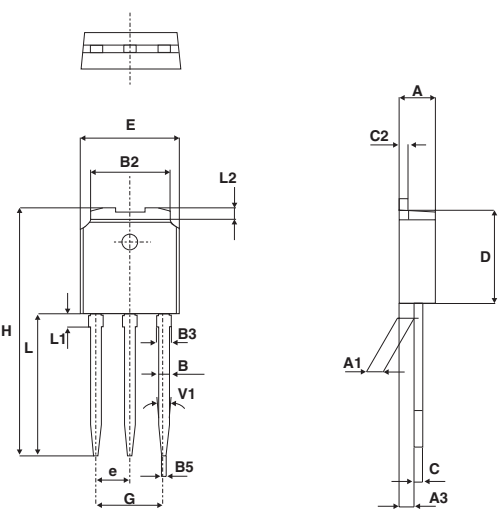
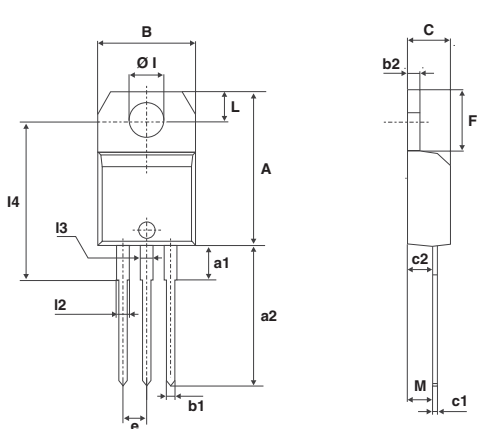

Table 7. IPAK dimensions



Ref.	Dimensions					
	Millimeters			Inches		
	Min.	Typ.	Max.	Min.	Typ.	Max.
A	2.20		2.40	0.086		0.094
A1	0.90		1.10	0.035		0.043
A3	0.70		1.30	0.027		0.051
B	0.64		0.90	0.025		0.035
B2	5.20		5.40	0.204		0.212
B3			0.95			0.037
B5		0.30			0.035	
C	0.45		0.60	0.017		0.023
C2	0.48		0.60	0.019		0.023
D	6		6.20	0.236		0.244
E	6.40		6.60	0.252		0.260
e		2.28			0.090	
G	4.40		4.60	0.173		0.181
H		16.10			0.634	
L	9		9.40	0.354		0.370
L1	0.8		1.20	0.031		0.047
L2		0.80	1		0.031	0.039
V1		10°			10°	

Table 8. TO-220AB dimensions



Ref.	Dimensions					
	Millimeters			Inches		
	Min.	Typ.	Max.	Min.	Typ.	Max.
A	15.20		15.90	0.598		0.625
a1		3.75			0.147	
a2	13.00		14.00	0.511		0.551
B	10.00		10.40	0.393		0.409
b1	0.61		0.88	0.024		0.034
b2	1.23		1.32	0.048		0.051
C	4.40		4.60	0.173		0.181
c1	0.49		0.70	0.019		0.027
c2	2.40		2.72	0.094		0.107
e	2.40		2.70	0.094		0.106
F	6.20		6.60	0.244		0.259
ØI	3.75		3.85	0.147		0.151
l4	15.80	16.40	16.80	0.622	0.646	0.661
L	2.65		2.95	0.104		0.116
l2	1.14		1.70	0.044		0.066
l3	1.14		1.70	0.044		0.066
M		2.60			0.102	

4 Ordering information

Table 9. Ordering information

Order code	Marking	Package	Weight	Base qty	Delivery mode
TS420-600B	TS420600	DPAK	0.3 g	75	Tube
TS420-600B-TR	TS420600			2500	Tape and reel
TS420-600H	TS420600	IPAK	0.4 g	75	Tube
TS420-600T	TS420600T	TO-220AB	2.3 g	50	Tube
TS420-700B	TS420700	DPAK	0.3 g	75	Tube
TS420-700B-TR	TS420700			2500	Tape and reel
TS420-700H	TS420700	IPAK	0.4 g	75	Tube
TS420-700T	TS420700T	TO-220AB	2.3 g	50	Tube

5 Revision history

Table 10. Document revision history

Date	Revision	Changes
Sep-2000	3	Previous release.
26-Jan-2010	4	Updated package illustration for TO-220AB on front page and Table 8 . Added Table 3 .

Please Read Carefully:

Information in this document is provided solely in connection with ST products. STMicroelectronics NV and its subsidiaries ("ST") reserve the right to make changes, corrections, modifications or improvements, to this document, and the products and services described herein at any time, without notice.

All ST products are sold pursuant to ST's terms and conditions of sale.

Purchasers are solely responsible for the choice, selection and use of the ST products and services described herein, and ST assumes no liability whatsoever relating to the choice, selection or use of the ST products and services described herein.

No license, express or implied, by estoppel or otherwise, to any intellectual property rights is granted under this document. If any part of this document refers to any third party products or services it shall not be deemed a license grant by ST for the use of such third party products or services, or any intellectual property contained therein or considered as a warranty covering the use in any manner whatsoever of such third party products or services or any intellectual property contained therein.

UNLESS OTHERWISE SET FORTH IN ST'S TERMS AND CONDITIONS OF SALE ST DISCLAIMS ANY EXPRESS OR IMPLIED WARRANTY WITH RESPECT TO THE USE AND/OR SALE OF ST PRODUCTS INCLUDING WITHOUT LIMITATION IMPLIED WARRANTIES OF MERCHANTABILITY, FITNESS FOR A PARTICULAR PURPOSE (AND THEIR EQUIVALENTS UNDER THE LAWS OF ANY JURISDICTION), OR INFRINGEMENT OF ANY PATENT, COPYRIGHT OR OTHER INTELLECTUAL PROPERTY RIGHT.

UNLESS EXPRESSLY APPROVED IN WRITING BY AN AUTHORIZED ST REPRESENTATIVE, ST PRODUCTS ARE NOT RECOMMENDED, AUTHORIZED OR WARRANTED FOR USE IN MILITARY, AIR CRAFT, SPACE, LIFE SAVING, OR LIFE SUSTAINING APPLICATIONS, NOR IN PRODUCTS OR SYSTEMS WHERE FAILURE OR MALFUNCTION MAY RESULT IN PERSONAL INJURY, DEATH, OR SEVERE PROPERTY OR ENVIRONMENTAL DAMAGE. ST PRODUCTS WHICH ARE NOT SPECIFIED AS "AUTOMOTIVE GRADE" MAY ONLY BE USED IN AUTOMOTIVE APPLICATIONS AT USER'S OWN RISK.

Resale of ST products with provisions different from the statements and/or technical features set forth in this document shall immediately void any warranty granted by ST for the ST product or service described herein and shall not create or extend in any manner whatsoever, any liability of ST.

ST and the ST logo are trademarks or registered trademarks of ST in various countries.

Information in this document supersedes and replaces all information previously supplied.

The ST logo is a registered trademark of STMicroelectronics. All other names are the property of their respective owners.

© 2010 STMicroelectronics - All rights reserved

STMicroelectronics group of companies

Australia - Belgium - Brazil - Canada - China - Czech Republic - Finland - France - Germany - Hong Kong - India - Israel - Italy - Japan - Malaysia - Malta - Morocco - Philippines - Singapore - Spain - Sweden - Switzerland - United Kingdom - United States of America

www.st.com