

18-BIT, 1-MSPS, PSEUDO-BIPOLAR, FULLY DIFFERENTIAL INPUT, MICROPOWER SAMPLING ANALOG-TO-DIGITAL CONVERTER WITH PARALLEL INTERFACE, REFERENCE

FEATURES

- 0 to 1-MHz Sample Rate
- ± 1.2 LSB Typ, ± 2.5 LSB Max INL
- $+0.75/-0.6$ LSB Typ, $+1.5/-1$ LSB Max DNL
- 18-Bit NMC Ensured Over Temperature
- ± 0.05 -mV Offset Error
- ± 0.05 -PPM/ $^{\circ}$ C Offset Error Drift
- ± 0.035 %FSR Gain Error
- ± 0.5 -PPM/ $^{\circ}$ C Gain Error Drift
- 99dB SNR, -121dB THD, 123dB SFDR
- Zero Latency
- Low Power: 225 mW at 1 MSPS
- Unipolar Differential Input Range: V_{ref} to $-V_{ref}$
- Onboard Reference with 6 PPM/ $^{\circ}$ C Drift
- Onboard Reference Buffer
- High-Speed Parallel Interface
- Wide Digital Supply 2.7 V to 5.25 V
- 8-/16-/18-Bit Bus Transfer
- 48-Pin 7x7 QFN Package

APPLICATIONS

- Medical Instruments
- Optical Networking
- Transducer Interface
- High Accuracy Data Acquisition Systems
- Magnetometers

DESCRIPTION

The ADS8482 is an 18-bit, 1-MSPS A/C converter with an internal 4.096-V reference and a pseudo-bipolar, fully differential input. The device includes a 18-bit capacitor-based SAR A/D converter with inherent sample and hold. The ADS8482 offers a full 18-bit interface, a 16-bit option where data is read using two read cycles, or an 8-bit bus option using three read cycles.

The ADS8482 is available in a 48-lead 7x7 QFN package and is characterized over the industrial -40° C to 85° C temperature range.

HIGH SPEED SAR CONVERTER FAMILY

TYPE/SPEED	500 kHz	~600 kHz	750 kHz	1 MHz	1.25 MHz	2 MHz	3 MHz	4MHz
18-Bit Pseudo-Diff	ADS8383	ADS8381		ADS8481				
		ADS8380 (s)						
18-Bit Pseudo-Bipolar, Fully Diff		ADS8382 (s)		ADS8482				
16-Bit Pseudo-Diff	ADS8327	ADS8370 (s)	ADS8371	ADS8471	ADS8401	ADS8411		
	ADS8328	ADS8372 (s)			ADS8405	ADS8410 (s)		
16-Bit Pseudo-Bipolar, Fully Diff				ADS8472	ADS8402	ADS8412		ADS8422
					ADS8406	ADS8413 (s)		
14-Bit Pseudo-Diff					ADS7890 (s)		ADS7891	
12-Bit Pseudo-Diff				ADS7886		ADS7883		ADS7881

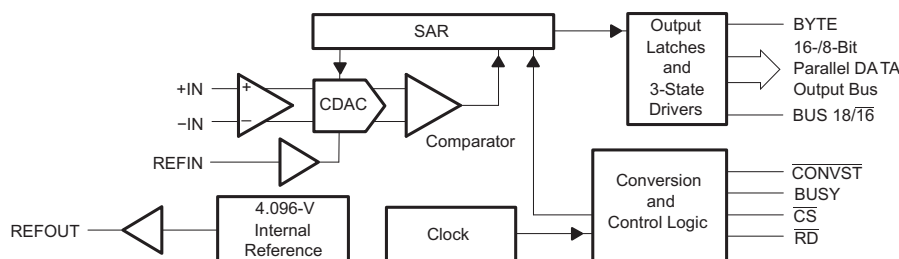

Please be aware that an important notice concerning availability, standard warranty, and use in critical applications of Texas Instruments semiconductor products and disclaimers thereto appears at the end of this data sheet.



These devices have limited built-in ESD protection. The leads should be shorted together or the device placed in conductive foam during storage or handling to prevent electrostatic damage to the MOS gates.

ORDERING INFORMATION⁽¹⁾

MODEL	MAXIMUM INTEGRAL LINEARITY (LSB)	MAXIMUM DIFFERENTIAL LINEARITY (LSB)	NO MISSING CODES RESOLUTION (BIT)	PACKAGE TYPE	PACKAGE DESIGNATOR	TEMPER-ATURE RANGE	ORDERING INFORMATION	TRANS-PORT MEDIA QTY.
ADS8482I	±4	-1 to +1.5	18	7x7 48 Pin QFN	RGZ	-40°C to 85°C	ADS8482IRGZT	Tape and reel 250
							ADS8482IRGZR	Tape and reel 1000
ADS8482IB	±2.5	-1 to +1.5	18	7x7 48 Pin QFN	RGZ	-40°C to 85°C	ADS8482IBRGZT	Tape and reel 250
							ADS8482IBRGZR	Tape and reel 1000

(1) For the most current specifications and package information, refer to our website at www.ti.com.

ABSOLUTE MAXIMUM RATINGS⁽¹⁾

over operating free-air temperature range (unless otherwise noted)

		VALUE	UNIT
Voltage	+IN to AGND	-0.4 to +VA + 0.1	V
	-IN to AGND	-0.4 to +VA + 0.1	V
	+VA to AGND	-0.3 to 7	V
	+VBD to BDGND	-0.3 to 7	V
	+VA to +VBD	-0.3 to 2.55	V
Digital input voltage to BDGND		-0.3 to +VBD + 0.3	V
Digital output voltage to BDGND		-0.3 to +VBD + 0.3	V
T _A	Operating free-air temperature range	-40 to 85	°C
T _{stg}	Storage temperature range	-65 to 150	°C
Junction temperature (T _J max)		150	°C
QFN package	Power dissipation	(T _J Max - T _A)/θ _{JA}	
	θ _{JA} thermal impedance	22	°C/W
Lead temperature, soldering	Vapor phase (60 sec)	215	°C
	Infrared (15 sec)	220	°C

(1) Stresses beyond those listed under *absolute maximum ratings* may cause permanent damage to the device. These are stress ratings only, and functional operation of the device at these or any other conditions beyond those indicated under *recommended operating conditions* is not implied. Exposure to absolute-maximum-rated conditions for extended periods may affect device reliability.

SPECIFICATIONS
 $T_A = -40^{\circ}\text{C}$ to 85°C , $+V_A = 5\text{ V}$, $+V_{BD} = 3\text{ V}$ or 5 V , $V_{ref} = 4.096\text{ V}$, $f_{SAMPLE} = 1\text{ MSPS}$ (unless otherwise noted)

PARAMETER		TEST CONDITIONS	MIN	TYP	MAX	UNIT
ANALOG INPUT						
Full-scale input voltage ⁽¹⁾		+IN – (–IN)	$-V_{ref}$		V_{ref}	V
Absolute input voltage		+IN	–0.2		$V_{ref} + 0.2$	V
		–IN	–0.2		$V_{ref} + 0.2$	
Common-mode input range			$(V_{ref})/2 - 0.2$	$(V_{ref})/2$	$(V_{ref})/2 + 0.2$	V
Input capacitance				65		pF
Input leakage current				1		nA
SYSTEM PERFORMANCE						
Resolution				18		Bits
No missing codes	ADS8482I		18			Bits
	ADS8482IB		18			
Integral linearity ⁽²⁾	ADS8482I		–4	± 1.2	4	LSB (18 bit) ⁽³⁾
	ADS8482IB		–2.5	± 1.2	2.5	
Differential linearity	ADS8482I		–1	–0.6/0.75	1.5	LSB (18 bit)
	ADS8482IB		–1	–0.6/0.75	1.5	
Offset error ⁽⁴⁾	ADS8482I		–0.5	± 0.05	0.5	mV
	ADS8482IB		–0.5	± 0.05	0.5	
Offset error temperature drift	ADS8482I			± 0.05		ppm/ $^{\circ}\text{C}$
	ADS8482IB			± 0.05		
Gain error ⁽⁴⁾⁽⁵⁾	ADS8482I	$V_{ref} = 4.096\text{ V}$	–0.1	± 0.035	0.1	%FS
	ADS8482IB	$V_{ref} = 4.096\text{ V}$	–0.1	± 0.035	0.1	%FS
Gain error temperature drift	ADS8482I			± 0.5		ppm/ $^{\circ}\text{C}$
	ADS8482IB			± 0.5		
Common-mode rejection ratio	At dc ($\pm 0.2\text{ V}$ around $V_{ref}/2$)			60		dB
	+IN – (–IN) = 1 Vpp at 1 MHz			55		
Noise				25		$\mu\text{V RMS}$
Power supply rejection ratio		At 1FFFFh output code		60		dB
SAMPLING DYNAMICS						
Conversion time				625	650	ns
Acquisition time			320	350		ns
Throughput rate					1	MHz
Aperture delay				4		ns
Aperture jitter				5		ps
Step response				150		ns
Over voltage recovery				150		ns

(1) Ideal input span, does not include gain or offset error.

(2) This is endpoint INL, not best fit.

(3) LSB means least significant bit

(4) Measured relative to an ideal full-scale input [+IN – (–IN)] of 8.192 V

(5) This specification does not include the internal reference voltage error and drift.

SPECIFICATIONS (Continued)

$T_A = -40^{\circ}\text{C}$ to 85°C , $+VA = 5\text{ V}$, $+VBD = 3\text{ V}$ or 5 V , $V_{ref} = 4.096\text{ V}$, $f_{SAMPLE} = 1\text{ MSPS}$ (unless otherwise noted)

PARAMETER		TEST CONDITIONS	MIN	TYP	MAX	UNIT	
DYNAMIC CHARACTERISTICS							
Total harmonic distortion (THD) ⁽¹⁾	ADS8482I	$V_{IN} = 8 V_{pp}$ at 2 kHz			-120	dB	
	ADS8482IB				-121		
	ADS8482I	$V_{IN} = 8 V_{pp}$ at 20 kHz			-105		
	ADS8482IB				-110		
	ADS8482I	$V_{IN} = 8 V_{pp}$ at 100 kHz			-100		
	ADS8482IB				-103		
Signal to noise ratio (SNR) ⁽¹⁾	ADS8482I	$V_{IN} = 8 V_{pp}$ at 2 kHz	96	98.6	dB		
	ADS8482IB		97.5	99			
	ADS8482I	$V_{IN} = 8 V_{pp}$ at 20 kHz					98
	ADS8482IB						98.5
	ADS8482I	$V_{IN} = 8 V_{pp}$ at 100 kHz					95
	ADS8482IB						97
Signal to noise + distortion (SINAD) ⁽¹⁾	ADS8482I	$V_{IN} = 8 V_{pp}$ at 2 kHz	96	98.5	dB		
	ADS8482IB		97.5	99			
	ADS8482I	$V_{IN} = 8 V_{pp}$ at 20 kHz					97
	ADS8482IB						98
	ADS8482I	$V_{IN} = 8 V_{pp}$ at 100 kHz					93
	ADS8482IB						95
Spurious free dynamic range (SFDR) ⁽¹⁾	ADS8482I	$V_{IN} = 8 V_{pp}$ at 2 kHz			120	dB	
	ADS8482IB				123		
	ADS8482I	$V_{IN} = 8 V_{pp}$ at 20 kHz			107		
	ADS8482IB				113		
	ADS8482I	$V_{IN} = 8 V_{pp}$ at 100 kHz			102		
	ADS8482IB				105		
-3dB Small signal bandwidth					15	MHz	

(1) Calculated on the first nine harmonics of the input frequency.

SPECIFICATIONS (Continued)
 $T_A = -40^{\circ}\text{C}$ to 85°C , $+VA = 5\text{ V}$, $+VBD = 3\text{ V}$ or 5 V , $V_{\text{ref}} = 4.096\text{ V}$, $f_{\text{SAMPLE}} = 1\text{ MSPS}$ (unless otherwise noted)

PARAMETER		TEST CONDITIONS	MIN	TYP	MAX	UNIT
VOLTAGE REFERENCE INPUT						
Reference voltage at REFIN, V_{ref}			3.0	4.096	$+VA - 0.8$	V
Reference resistance ⁽¹⁾				500		k Ω
Reference current drain		$f_s = 1\text{ MHz}$			1	mA
INTERNAL REFERENCE OUTPUT						
Internal reference start-up time		From 95% (+VA), with 1- μF storage capacitor			120	ms
Reference voltage range, V_{ref}		$I_O = 0$	4.081	4.096	4.111	V
Source current		Static load			10	μA
Line regulation		$+VA = 4.75\text{ V} \sim 5.25\text{ V}$		60		μV
Drift		$I_O = 0$		± 6		PPM/ $^{\circ}\text{C}$
DIGITAL INPUT/OUTPUT						
Logic family –CMOS						
Logic level	V_{IH}	$I_{\text{IH}} = 5\ \mu\text{A}$	$+VBD - 1$		$+VBD + 0.3$	V
	V_{IL}	$I_{\text{IL}} = 5\ \mu\text{A}$	-0.3		0.8	
	V_{OH}	$I_{\text{OH}} = 2\text{ TTL loads}$	$+VBD - 0.6$			
	V_{OL}	$I_{\text{OL}} = 2\text{ TTL loads}$				
Data format – Straight Binary						
POWER SUPPLY REQUIREMENTS						
Power supply voltage	+VBD		2.7	3.3	5.25	V
	+VA		4.75	5	5.25	V
Supply current ⁽²⁾		$f_s = 1\text{ MHz}$		45	50	mA
Power dissipation ⁽²⁾		$f_s = 1\text{ MHz}$		225	250	mW
TEMPERATURE RANGE						
Operating free-air			-40		85	$^{\circ}\text{C}$

 (1) Can vary $\pm 20\%$

(2) This includes only +VA current. +VBD current is typical 1 mA with 5 pF load capacitance on all output pins.

TIMING CHARACTERISTICS

All specifications typical at –40°C to 85°C, +VA =+VBD = 5 V ⁽¹⁾⁽²⁾⁽³⁾

PARAMETER		MIN	TYP	MAX	UNIT
t _(CONV)	Conversion time			650	ns
t _(ACQ)	Acquisition time	320			ns
t _(HOLD)	Sample capacitor hold time			25	ns
t _{pd1}	$\overline{\text{CONVST}}$ low to BUSY high			40	ns
t _{pd2}	Propagation delay time, end of conversion to BUSY low			15	ns
t _{pd3}	Propagation delay time, start of convert state to rising edge of BUSY			15	ns
t _{w1}	Pulse duration, $\overline{\text{CONVST}}$ low	40			ns
t _{su1}	Setup time, $\overline{\text{CS}}$ low to $\overline{\text{CONVST}}$ low	20			ns
t _{w2}	Pulse duration, $\overline{\text{CONVST}}$ high	20			ns
	$\overline{\text{CONVST}}$ falling edge jitter			10	ps
t _{w3}	Pulse duration, BUSY signal low	t _(ACQ) min			ns
t _{w4}	Pulse duration, BUSY signal high			650	ns
t _{h1}	Hold time, first data bus transition ($\overline{\text{RD}}$ low, or $\overline{\text{CS}}$ low for read cycle, or BYTE or BUS18/16 input changes) after $\overline{\text{CONVST}}$ low	40			ns
t _{d1}	Delay time, $\overline{\text{CS}}$ low to $\overline{\text{RD}}$ low	0			ns
t _{su2}	Setup time, $\overline{\text{RD}}$ high to $\overline{\text{CS}}$ high	0			ns
t _{w5}	Pulse duration, $\overline{\text{RD}}$ low	50			ns
t _{en}	Enable time, $\overline{\text{RD}}$ low (or $\overline{\text{CS}}$ low for read cycle) to data valid			20	ns
t _{d2}	Delay time, data hold from $\overline{\text{RD}}$ high	5			ns
t _{d3}	Delay time, BUS18/16 or BYTE rising edge or falling edge to data valid	10		20	ns
t _{w6}	Pulse duration, $\overline{\text{RD}}$ high	20			ns
t _{w7}	Pulse duration, $\overline{\text{CS}}$ high	20			ns
t _{h2}	Hold time, last $\overline{\text{RD}}$ (or $\overline{\text{CS}}$ for read cycle) rising edge to $\overline{\text{CONVST}}$ falling edge	50			ns
t _{pd4}	Propagation delay time, BUSY falling edge to next $\overline{\text{RD}}$ (or $\overline{\text{CS}}$ for read cycle) falling edge	0			ns
t _{d4}	Delay time, BYTE edge to BUS18/16 edge skew	0			ns
t _{su3}	Setup time, BYTE or BUS18/16 transition to $\overline{\text{RD}}$ falling edge	10			ns
t _{h3}	Hold time, BYTE or BUS18/16 transition to $\overline{\text{RD}}$ falling edge	10			ns
t _{dis}	Disable time, $\overline{\text{RD}}$ high ($\overline{\text{CS}}$ high for read cycle) to 3-stated data bus			20	ns
t _{d5}	Delay time, BUSY low to MSB data valid delay			0	ns
t _{d6}	Delay time, $\overline{\text{CS}}$ rising edge to BUSY falling edge	50			ns
t _{d7}	Delay time, BUSY falling edge to $\overline{\text{CS}}$ rising edge	50			ns
t _{su5}	BYTE transition setup time, from BYTE transition to next BYTE transition, or BUS18/16 transition setup time, from BUS18/16 to next BUS18/16.	50			ns
t _{su(ABORT)}	Setup time from the falling edge of $\overline{\text{CONVST}}$ (used to start the valid conversion) to the next falling edge of $\overline{\text{CONVST}}$ (when CS = 0 and $\overline{\text{CONVST}}$ are used to abort) or to the next falling edge of $\overline{\text{CS}}$ (when $\overline{\text{CS}}$ is used to abort).	60		550	ns

- (1) All input signals are specified with t_r = t_f = 5 ns (10% to 90% of +VBD) and timed from a voltage level of (V_{IL} + V_{IH})/2.
- (2) See timing diagrams.
- (3) All timing are measured with 20 pF equivalent loads on all data bits and BUSY pins.

TIMING CHARACTERISTICS

All specifications typical at -40°C to 85°C , $+V_A = 5\text{ V}$ $+V_{BD} = 3\text{ V}$ ⁽¹⁾⁽²⁾⁽³⁾

PARAMETER		MIN	TYP	MAX	UNIT
$t_{(\text{CONV})}$	Conversion time			650	ns
$t_{(\text{ACQ})}$	Acquisition time	310			ns
$t_{(\text{HOLD})}$	Sample capacitor hold time			25	ns
t_{pd1}	$\overline{\text{CONVST}}$ low to BUSY high			40	ns
t_{pd2}	Propagation delay time, end of conversion to BUSY low			25	ns
t_{pd3}	Propagation delay time, start of convert state to rising edge of BUSY			25	ns
t_{w1}	Pulse duration, $\overline{\text{CONVST}}$ low	40			ns
t_{su1}	Setup time, $\overline{\text{CS}}$ low to $\overline{\text{CONVST}}$ low	20			ns
t_{w2}	Pulse duration, $\overline{\text{CONVST}}$ high	20			ns
	$\overline{\text{CONVST}}$ falling edge jitter			10	ps
t_{w3}	Pulse duration, BUSY signal low	$t_{(\text{ACQ})\text{min}}$			ns
t_{w4}	Pulse duration, BUSY signal high			650	ns
t_{h1}	Hold time, first data bus transition ($\overline{\text{RD}}$ low, or $\overline{\text{CS}}$ low for read cycle, or BYTE or BUS18/16 input changes) after $\overline{\text{CONVST}}$ low	40			ns
t_{d1}	Delay time, $\overline{\text{CS}}$ low to $\overline{\text{RD}}$ low	0			ns
t_{su2}	Setup time, $\overline{\text{RD}}$ high to $\overline{\text{CS}}$ high	0			ns
t_{w5}	Pulse duration, $\overline{\text{RD}}$ low	50			ns
t_{en}	Enable time, $\overline{\text{RD}}$ low (or $\overline{\text{CS}}$ low for read cycle) to data valid			30	ns
t_{d2}	Delay time, data hold from $\overline{\text{RD}}$ high	5			ns
t_{d3}	Delay time, BUS18/16 or BYTE rising edge or falling edge to data valid	10		30	ns
t_{w6}	Pulse duration, $\overline{\text{RD}}$ high	20			ns
t_{w7}	Pulse duration, $\overline{\text{CS}}$ high	20			ns
t_{h2}	Hold time, last $\overline{\text{RD}}$ (or $\overline{\text{CS}}$ for read cycle) rising edge to $\overline{\text{CONVST}}$ falling edge	50			ns
t_{pd4}	Propagation delay time, BUSY falling edge to next $\overline{\text{RD}}$ (or $\overline{\text{CS}}$ for read cycle) falling edge	0			ns
t_{d4}	Delay time, BYTE edge to BUS18/16 edge skew	0			ns
t_{su3}	Setup time, BYTE or BUS18/16 transition to $\overline{\text{RD}}$ falling edge	10			ns
t_{h3}	Hold time, BYTE or BUS18/16 transition to $\overline{\text{RD}}$ falling edge	10			ns
t_{dis}	Disable time, $\overline{\text{RD}}$ high ($\overline{\text{CS}}$ high for read cycle) to 3-stated data bus			30	ns
t_{d5}	Delay time, BUSY low to MSB data valid delay			0	ns
t_{d6}	Delay time, $\overline{\text{CS}}$ rising edge to BUSY falling edge	50			ns
t_{d7}	Delay time, BUSY falling edge to $\overline{\text{CS}}$ rising edge	50			ns
t_{su5}	BYTE transition setup time, from BYTE transition to next BYTE transition, or BUS18/16 transition setup time, from BUS18/16 to next BUS18/16.	50			ns
$t_{\text{su(ABORT)}}$	Setup time from the falling edge of $\overline{\text{CONVST}}$ (used to start the valid conversion) to the next falling edge of $\overline{\text{CONVST}}$ (when $\text{CS} = 0$ and $\overline{\text{CONVST}}$ are used to abort) or to the next falling edge of $\overline{\text{CS}}$ (when $\overline{\text{CS}}$ is used to abort).	70		550	ns

- (1) All input signals are specified with $t_r = t_f = 5\text{ ns}$ (10% to 90% of $+V_{BD}$) and timed from a voltage level of $(V_{IL} + V_{IH})/2$.
- (2) See timing diagrams.
- (3) All timing are measured with 20 pF equivalent loads on all data bits and BUSY pins.

PIN ASSIGNMENTS

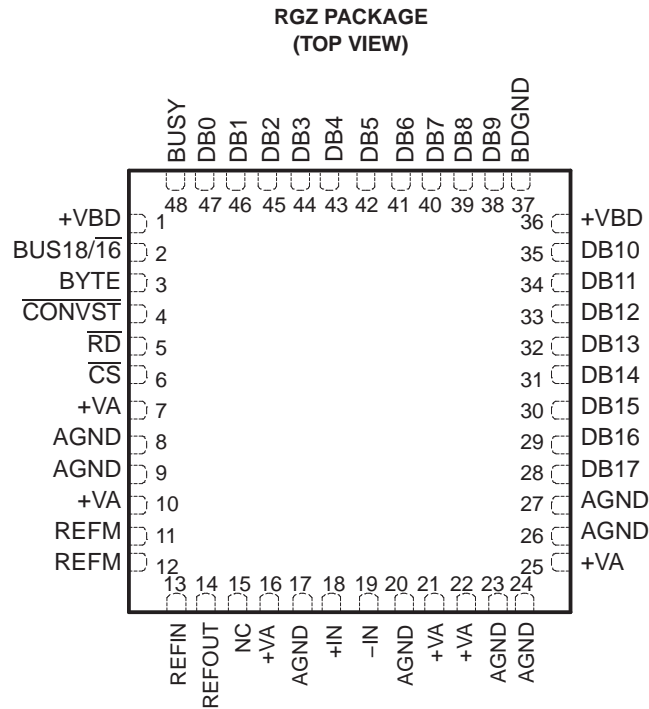

NC – No internal connection

NOTE: The package thermal pad must be soldered to the printed circuit board for thermal and mechanical performance.

TERMINAL FUNCTIONS

NAME	NO	I/O	DESCRIPTION					
AGND	8, 9, 17, 20, 23, 24, 26, 27	–	Analog ground					
BDGND	37	–	Digital ground for bus interface digital supply					
BUSY	48	O	Status output. High when a conversion is in progress.					
BUS18/16	2	I	Bus size select input. Used for selecting 18-bit or 16-bit wide bus transfer. 0: Data bits output on the 18-bit data bus pins DB[17:0]. 1: Last two data bits D[1:0] from 18-bit wide bus output on: a) the low byte pins DB[9:2] if BYTE = 0 b) the high byte pins DB[17:10] if BYTE = 1					
BYTE	3	I	Byte select input. Used for 8-bit bus reading. 0: No fold back 1: Low byte D[9:2] of the 16 most significant bits is folded back to high byte of the 16 most significant pins DB[17:10].					
CONVST	4	I	Convert start. The falling edge of this input ends the acquisition period and starts the hold period.					
CS	6	I	Chip select. The falling edge of this input starts the acquisition period.					
Data Bus			8-BIT BUS			16-BIT BUS		18-BIT BUS
			BYTE = 0	BYTE = 1	BYTE = 1	BYTE = 0	BYTE = 0	BYTE = 0
			BUS18/16 = 0	BUS18/16 = 0	BUS18/16 = 1	BUS18/16 = 0	BUS18/16 = 1	BUS18/16 = 0
DB17	28	O	D17 (MSB)	D9	All ones	D17 (MSB)	All ones	D17 (MSB)
DB16	29	O	D16	D8	All ones	D16	All ones	D16
DB15	30	O	D15	D7	All ones	D15	All ones	D15
DB14	31	O	D14	D6	All ones	D14	All ones	D14
DB13	32	O	D13	D5	All ones	D13	All ones	D13
DB12	33	O	D12	D4	All ones	D12	All ones	D12
DB11	34	O	D11	D3	D1	D11	All ones	D11
DB10	35	O	D10	D2	D0 (LSB)	D10	All ones	D10
DB9	38	O	D9	All ones	All ones	D9	All ones	D9

TERMINAL FUNCTIONS (continued)

NAME	NO	I/O	DESCRIPTION					
			D8	All ones	All ones	D8	All ones	D8
DB8	39	O	D8	All ones	All ones	D8	All ones	D8
DB7	40	O	D7	All ones	All ones	D7	All ones	D7
DB6	41	O	D6	All ones	All ones	D6	All ones	D6
DB5	42	O	D5	All ones	All ones	D5	All ones	D5
DB4	43	O	D4	All ones	All ones	D4	All ones	D4
DB3	44	O	D3	All ones	All ones	D3	D1	D3
DB2	45	O	D2	All ones	All ones	D2	D0 (LSB)	D2
DB1	46	O	D1	All ones	All ones	D1	All ones	D1
DB0	47	O	D0 (LSB)	All ones	All ones	D0 (LSB)	All ones	D0 (LSB)
-IN	19	I	Inverting input channel					
+IN	18	I	Noninverting input channel					
NC	15		No connection					
REFIN	13	I	Reference input					
REFOUT	14	O	Reference output. Add 1- μ F capacitor between the REFOUT pin and REFM pin when internal reference is used.					
REFM	11, 12	I	Reference ground					
\overline{RD}	5	I	Synchronization pulse for the parallel output. When \overline{CS} is low, this serves as output enable and puts the previous conversion results on the bus.					
+VA	7, 10, 16, 21, 22, 25	-	Analog power supplies, 5-V DC					
+VBD	1, 36	-	Digital power supply for bus					

TYPICAL CHARACTERISTICS

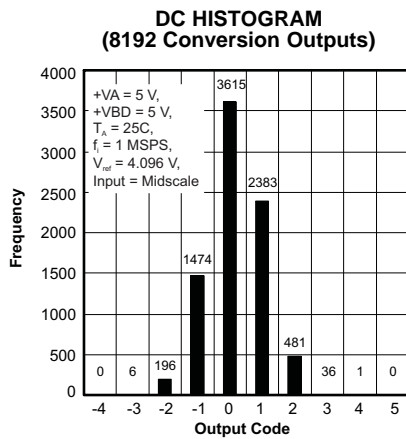

Figure 1.

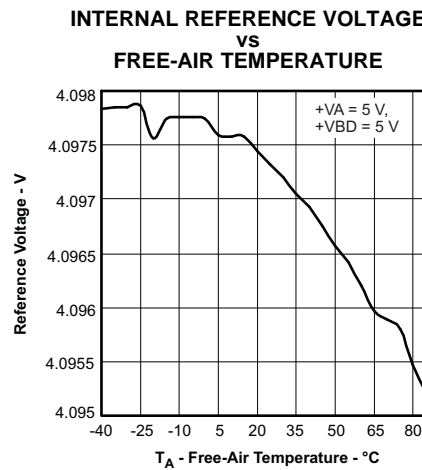

Figure 2.

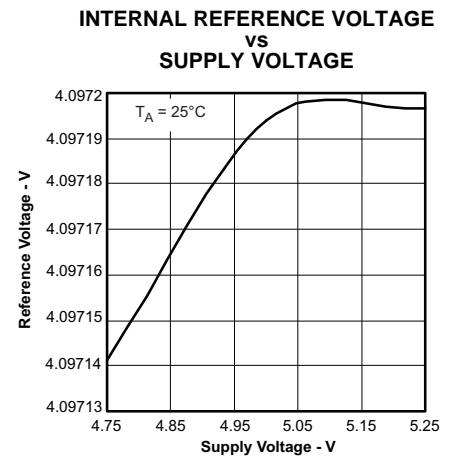

Figure 3.

TYPICAL CHARACTERISTICS (continued)

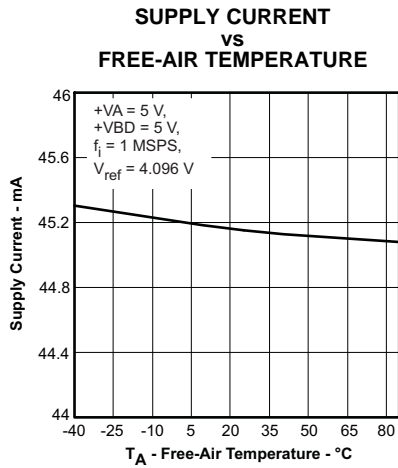

Figure 4.

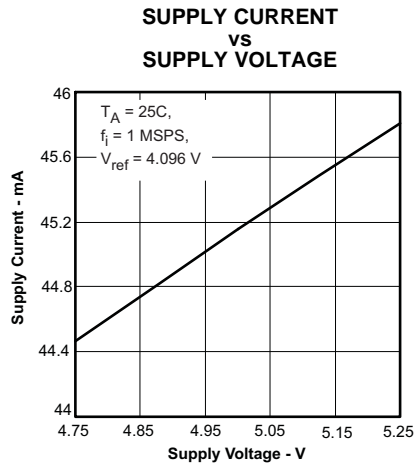

Figure 5.

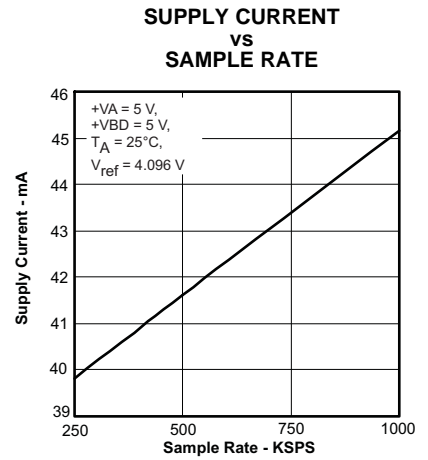

Figure 6.

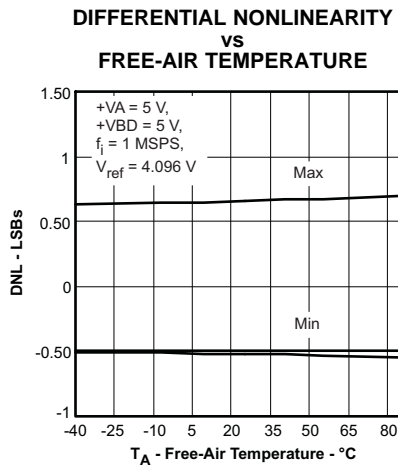

Figure 7.

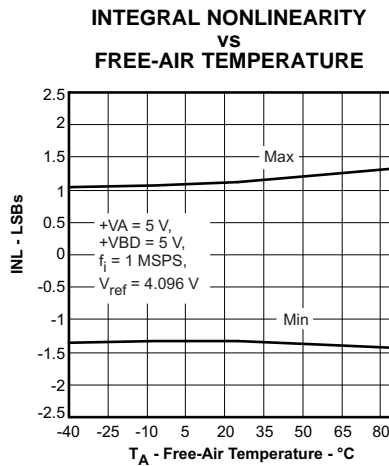

Figure 8.

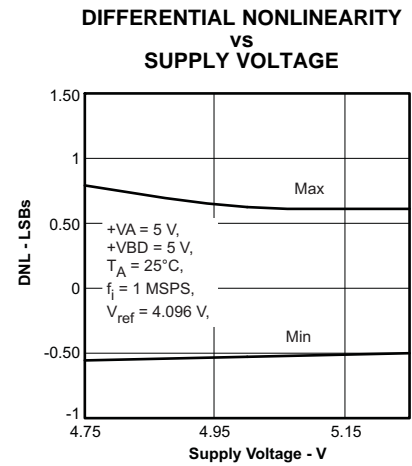

Figure 9.

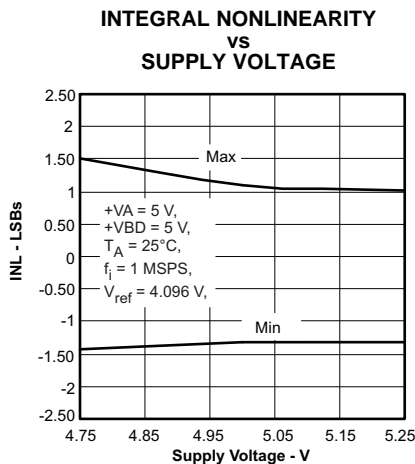

Figure 10.

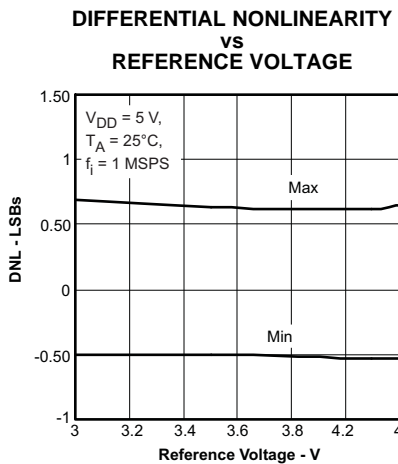

Figure 11.

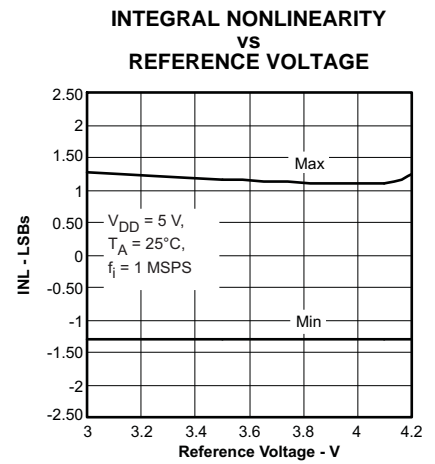

Figure 12.

TYPICAL CHARACTERISTICS (continued)

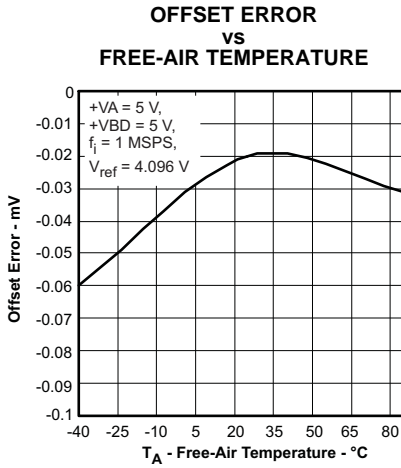

Figure 13.

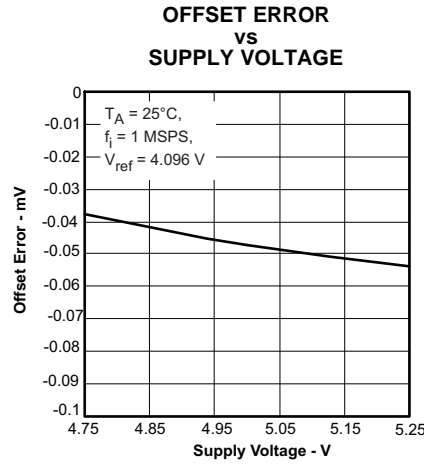

Figure 14.

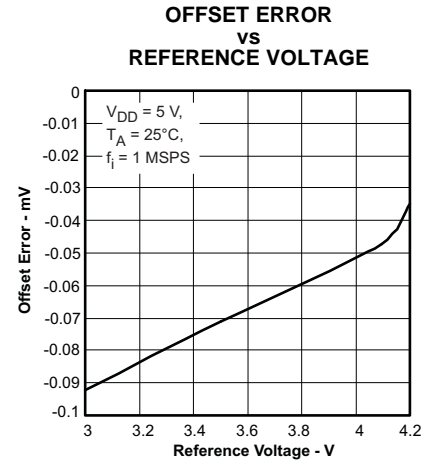

Figure 15.

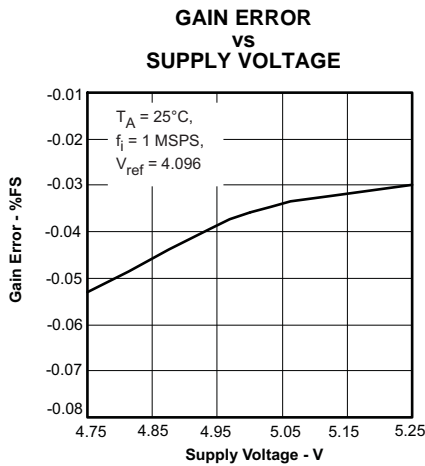

Figure 16.

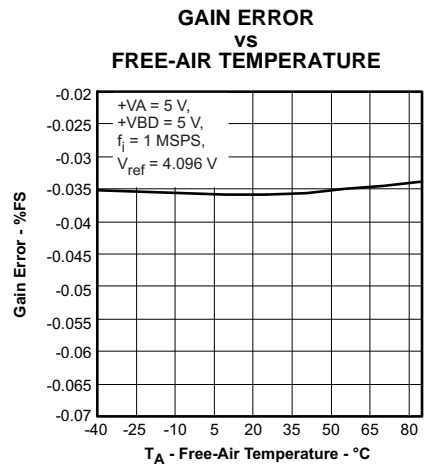

Figure 17.

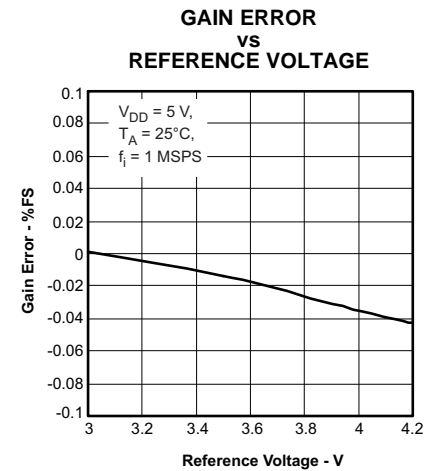

Figure 18.

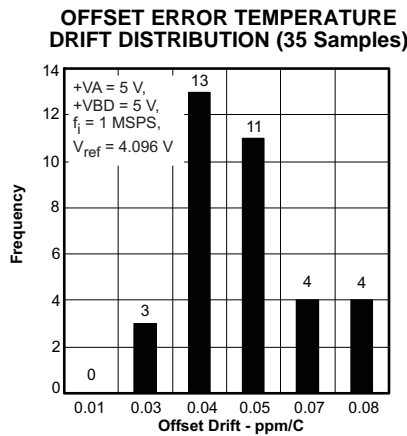

Figure 19.

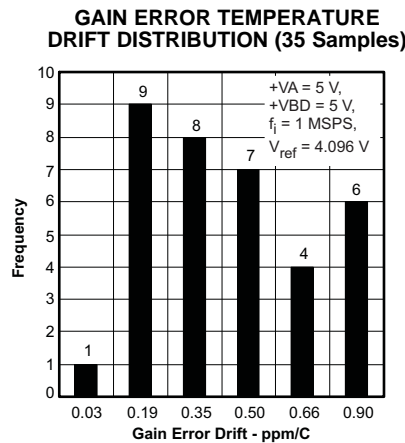

Figure 20.

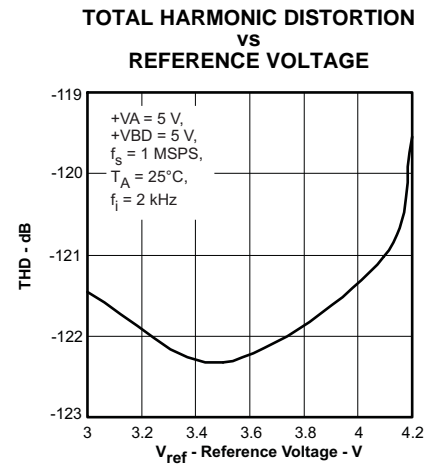

Figure 21.

TYPICAL CHARACTERISTICS (continued)

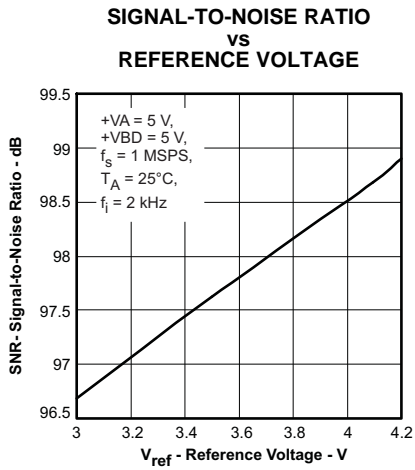

Figure 22.

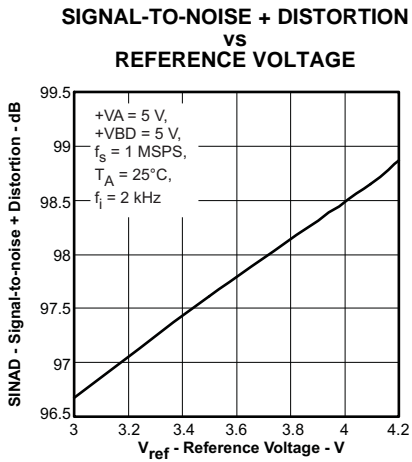

Figure 23.

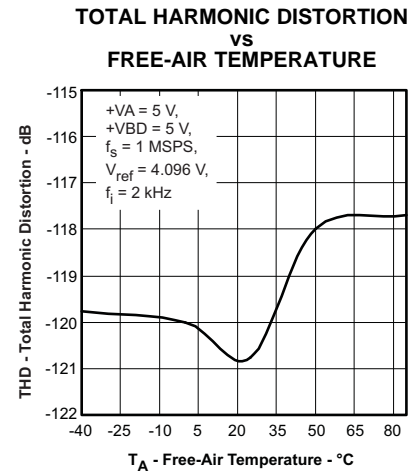

Figure 24.

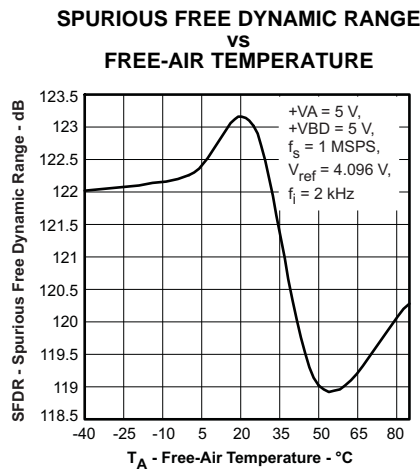

Figure 25.

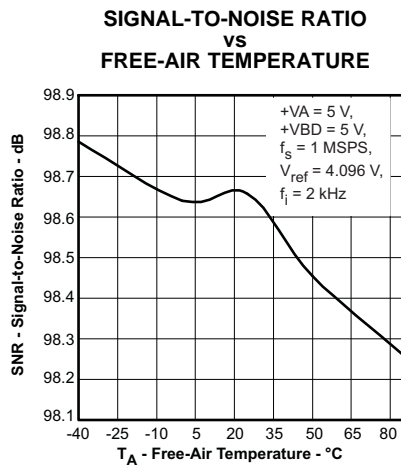

Figure 26.

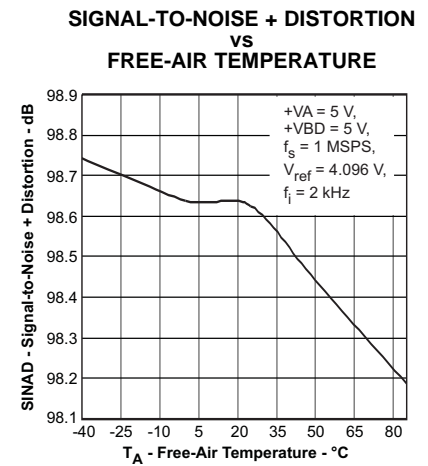

Figure 27.

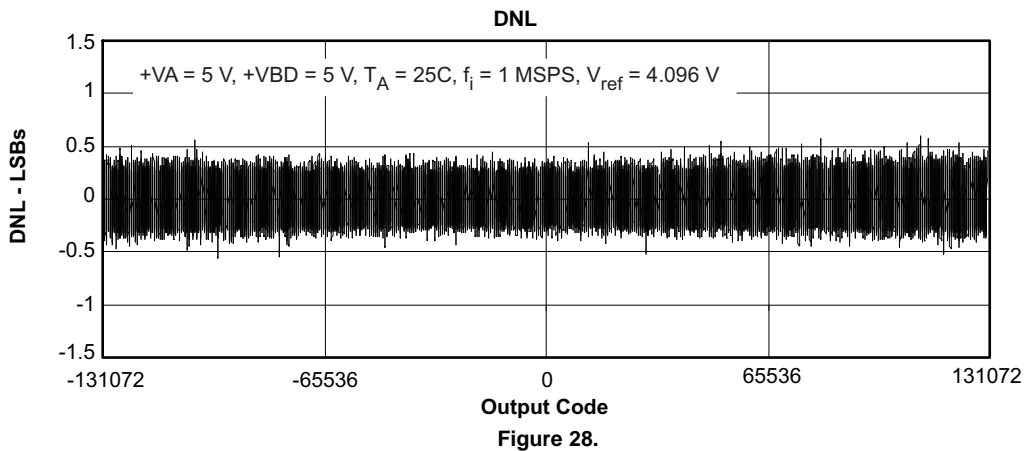

Figure 28.

TYPICAL CHARACTERISTICS (continued)

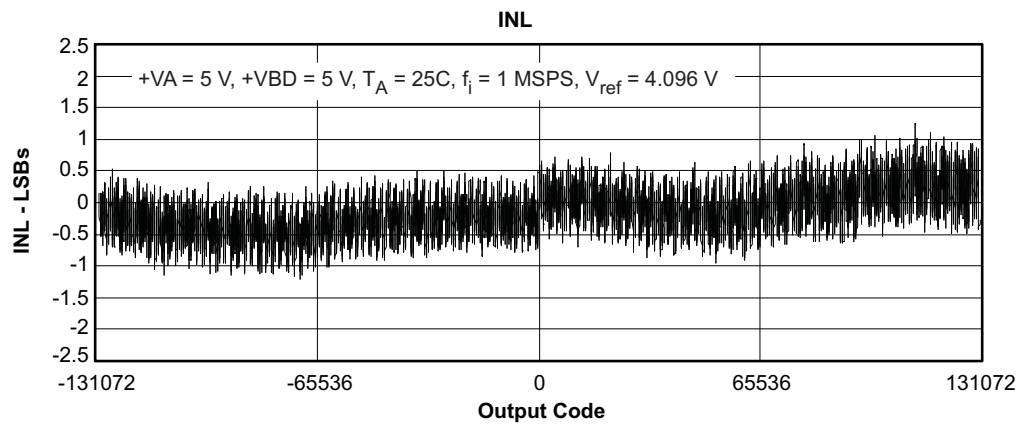
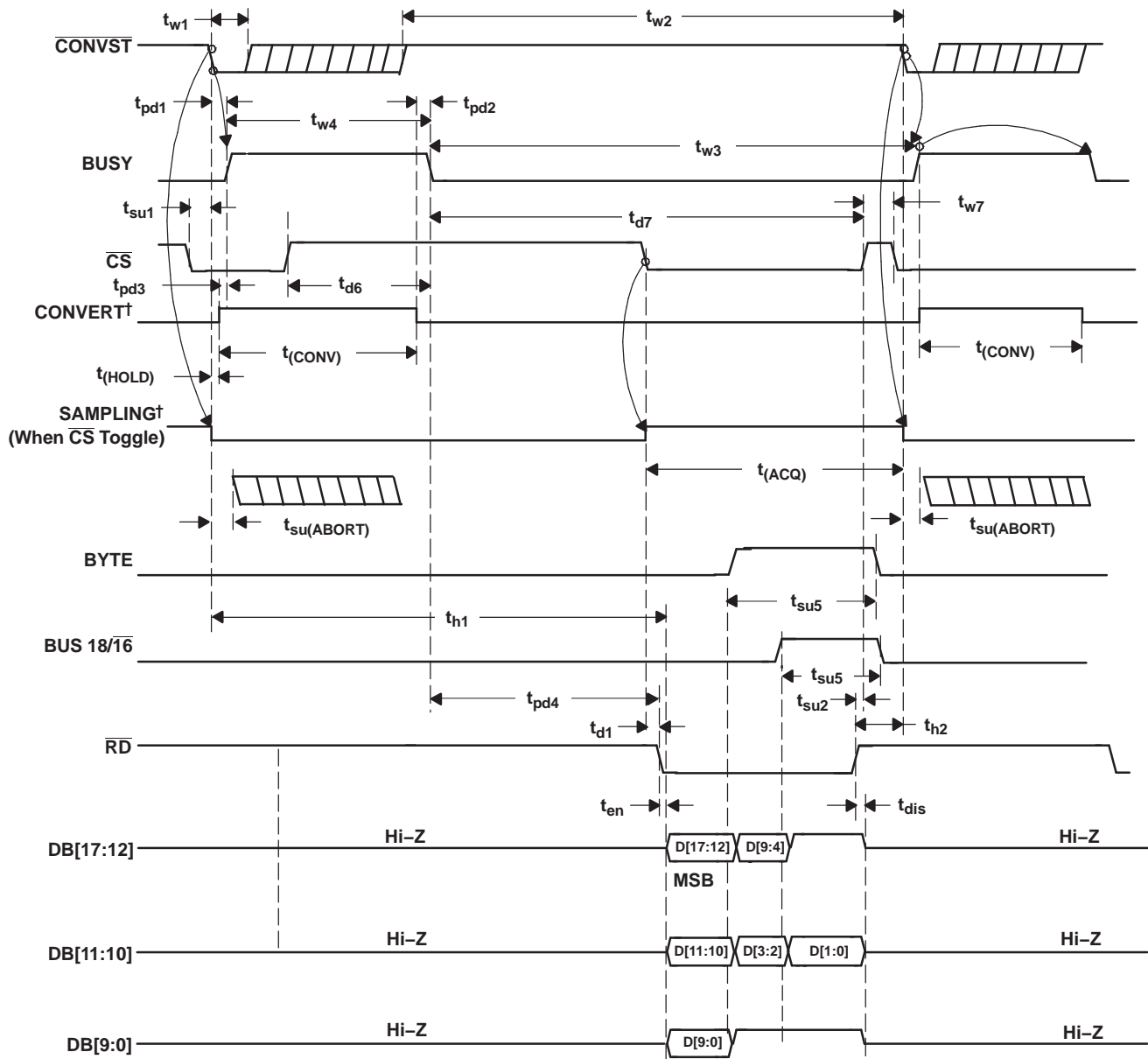

Figure 29.

TIMING DIAGRAMS



†Signal internal to device

Figure 30. Timing for Conversion and Acquisition Cycles With \overline{CS} and \overline{RD} Toggling

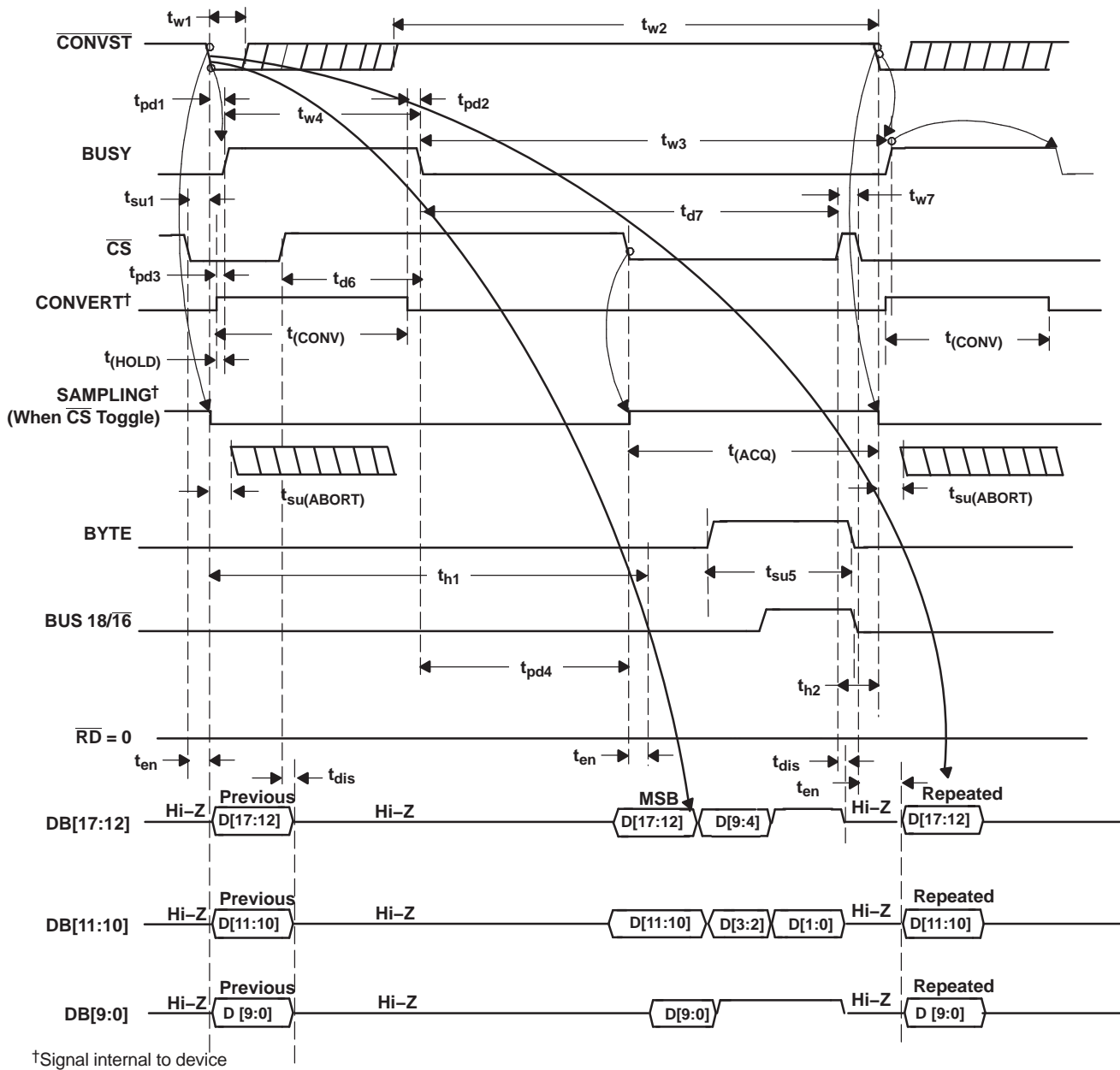
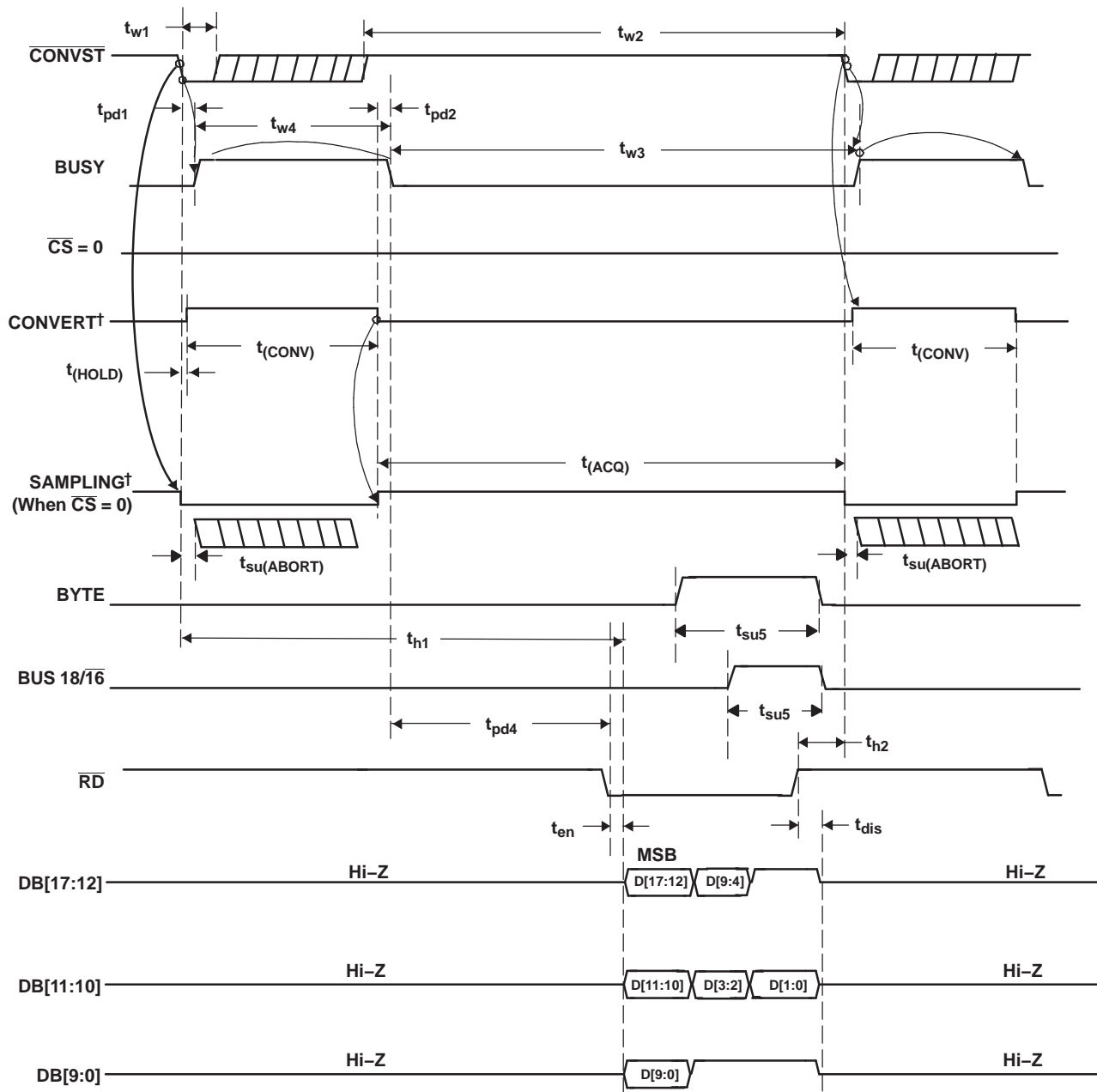
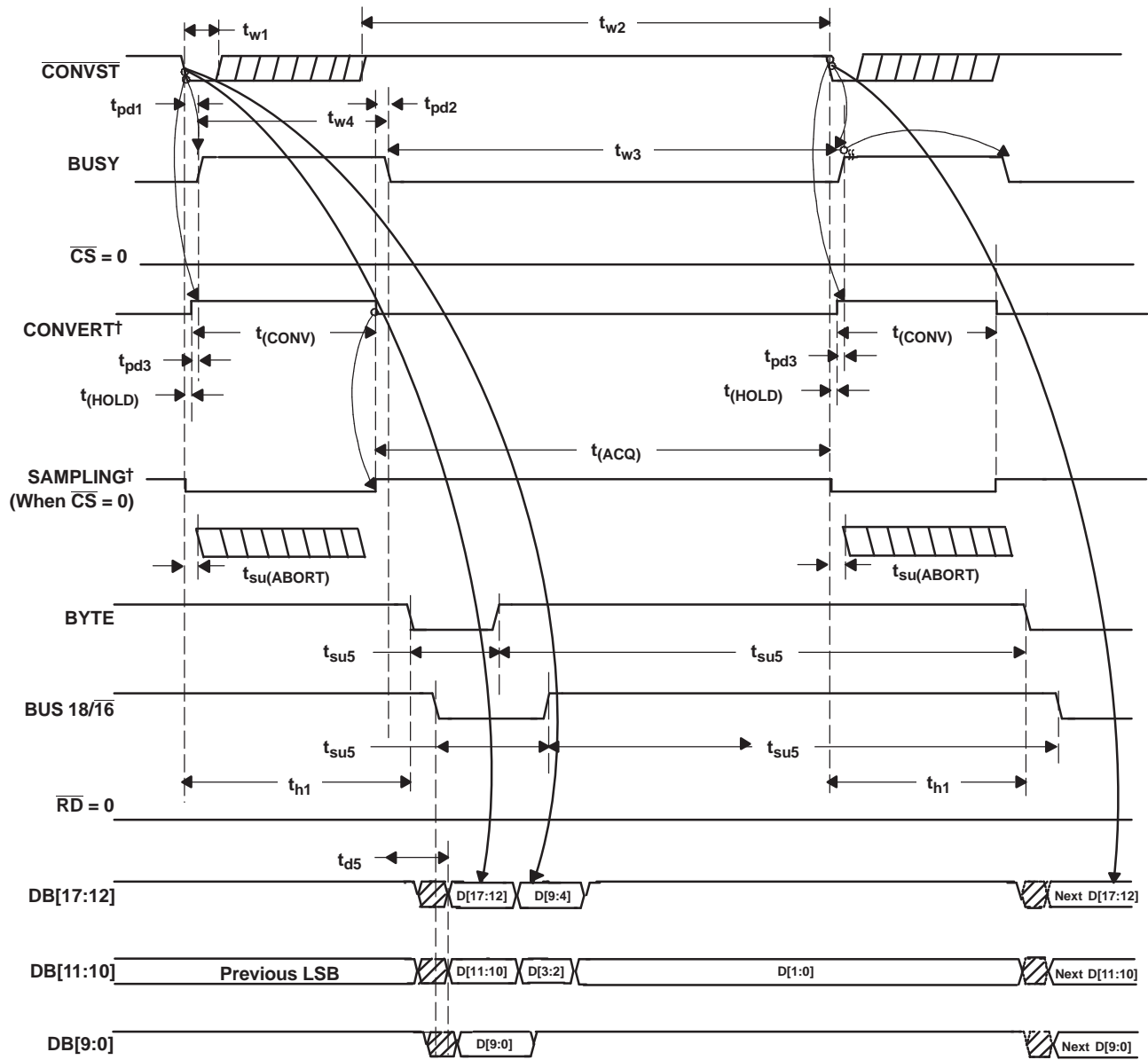

Figure 31. Timing for Conversion and Acquisition Cycles With \overline{CS} Toggling, \overline{RD} Tied to BDGND



†Signal internal to device

Figure 32. Timing for Conversion and Acquisition Cycles With \overline{CS} Tied to BDGND, \overline{RD} Toggling



†Signal internal to device

Figure 33. Timing for Conversion and Acquisition Cycles With \overline{CS} and \overline{RD} Tied to BDGND - Auto Read

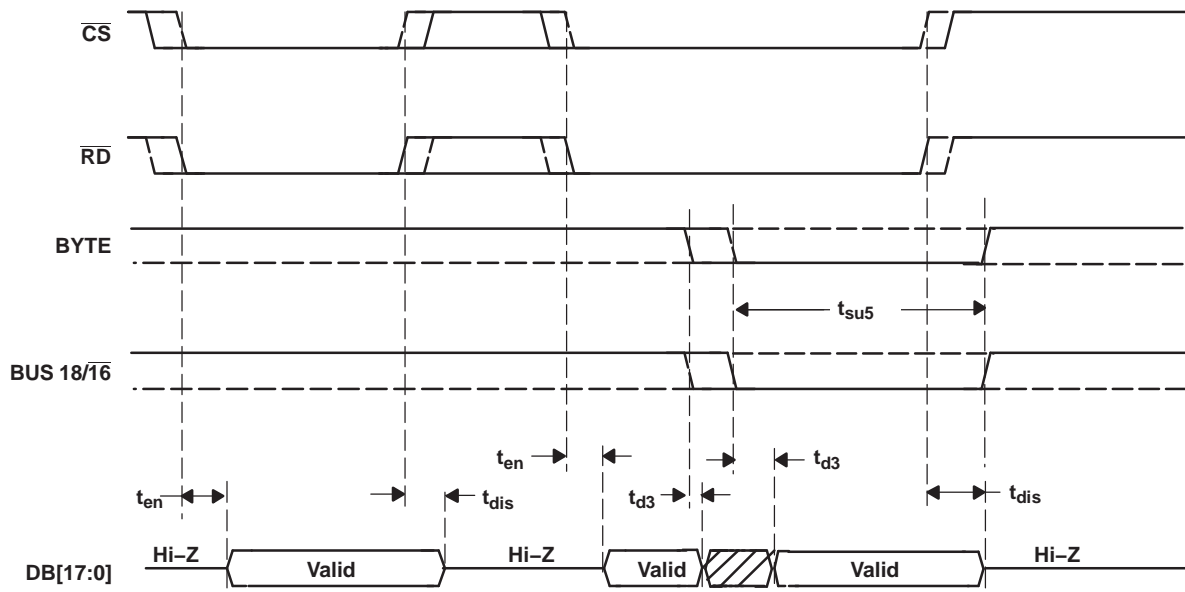

Figure 34. Detailed Timing for Read Cycles

PRINCIPLES OF OPERATION

The ADS8482 is a high-speed successive approximation register (SAR) analog-to-digital converter (ADC). The architecture is based on charge redistribution which inherently includes a sample/hold function. See [Figure 35](#) for the application circuit for the ADS8482.

The conversion clock is generated internally. The conversion time of 650 ns is capable of sustaining a 1 MHz throughput.

The analog input is provided to two input pins: +IN and -IN. When a conversion is initiated, the differential input on these pins is sampled on the internal capacitor array. While a conversion is in progress, both inputs are disconnected from any internal function.

REFERENCE

The ADS8482 can operate with an external reference with a range from 3.0 V to 4.2 V. The reference voltage on the input pin #13 (REFIN) of the converter is internally buffered. A clean, low noise, well-decoupled reference voltage on this pin is required to ensure good performance of the converter. A low noise band-gap reference like the REF3240 can be used to drive this pin. A 0.1- μ F decoupling capacitor is required between REFIN and REFM pins (pin #13 and pin #12) of the converter. This capacitor should be placed as close as possible to the pins of the device. Designers should strive to minimize the routing length of the traces that connect the terminals of the capacitor to the pins of the converter. An RC network can also be used to filter the reference voltage. A 100- Ω series resistor and a 0.1- μ F capacitor, which can also serve as the decoupling capacitor can be used to filter the reference voltage.

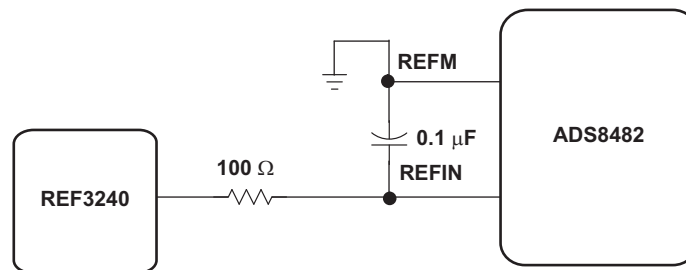

Figure 37. ADS8482 Using External Reference

The ADS8482 also has limited low pass filtering capability built into the converter. The equivalent circuitry on the REFIN input is as shown in [Figure 38](#).

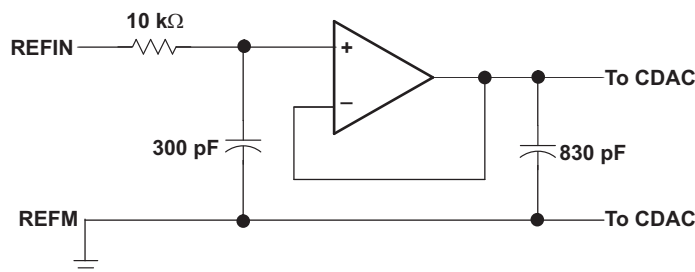

Figure 38. Simplified Reference Input Circuit

The REFM input of the ADS8482 should always be shorted to AGND. A 4.096-V internal reference is included. When internal reference is used, pin 14 (REFOUT) is connected to pin 13 (REFIN) with an 0.1- μ F decoupling capacitor and 1- μ F storage capacitor between pin 14 (REFOUT) and pins 11 and 12 (REFM) (see [Figure 36](#)). The internal reference of the converter is double buffered. If an external reference is used, the second buffer provides isolation between the external reference and the CDAC. This buffer is also used to recharge all of the capacitors of the CDAC during conversion. Pin 14 (REFOUT) can be left unconnected (floating) if external reference is used.

PRINCIPLES OF OPERATION (continued)

ANALOG INPUT

When the converter enters the hold mode, the voltage difference between the +IN and –IN inputs is captured on the internal capacitor array. Both +IN and –IN input has a range of -0.2 V to $V_{\text{ref}} + 0.2\text{ V}$. The input span [+IN – (–IN)] is limited to $-V_{\text{ref}}$ to V_{ref} .

The input current on the analog inputs depends upon a number of factors: sample rate, input voltage, and source impedance. Essentially, the current into the ADS8482 charges the internal capacitor array during the sample period. After this capacitance has been fully charged, there is no further input current. The source of the analog input must be able to charge the input capacitance (65 pF) to an 18-bit settling level within the acquisition time (320 ns) of the device. When the converter goes into the hold mode, the input impedance is greater than 1 G Ω .

Care must be taken regarding the absolute analog input voltage. To maintain the linearity of the converter, the +IN and –IN inputs and the span [+IN – (–IN)] must be within the limits specified. Outside of these ranges, the converter's linearity may not meet specifications. To minimize noise, low bandwidth input signals with low-pass filters are used.

Care must be taken to ensure that the output impedance of the sources driving the +IN and –IN inputs are matched. If this is not observed, the two inputs could have different settling times. This may result in offset error, gain error, and linearity error which varies with temperature and input voltage.

The analog input to the converter needs to be driven with a low noise, high-speed op-amp like the THS4031. An RC filter is recommended at the input pins to low-pass filter the noise from the source. The input to the converter is a uni-polar input voltage in the range 0 to V_{ref} . The THS4031 can be used in the source follower configuration to drive the converter.

PRINCIPLES OF OPERATION (continued)

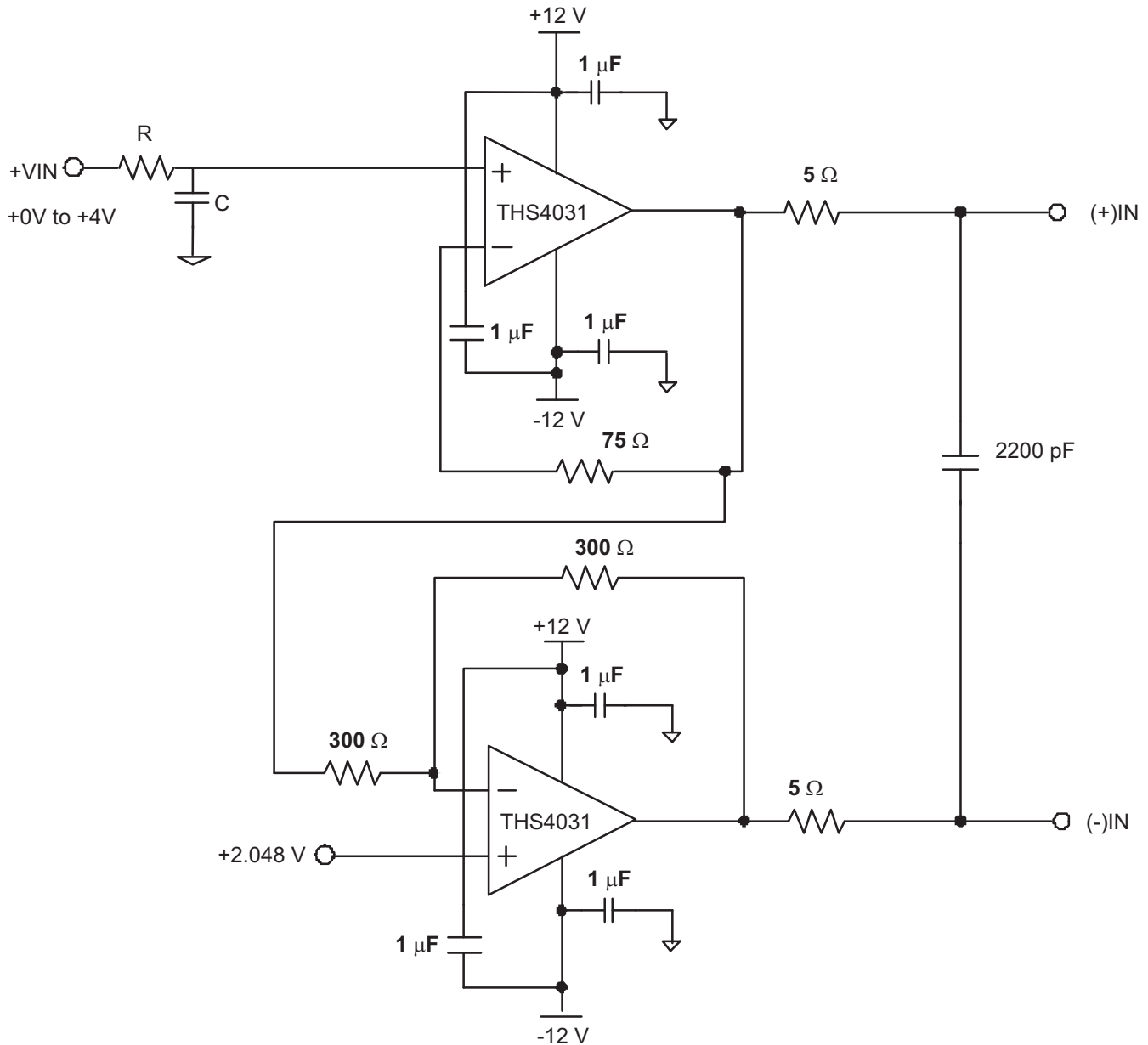

Figure 39. Single-Ended Input, Differential Output Configuration

In systems, where the input is differential, the THS4031 can be used in the inverting configuration with an additional DC bias applied to its + input so as to keep the input to the ADS8482 within its rated operating voltage range. The DC bias can be derived from the REF3220 or the REF3240 reference voltage ICs. The input configuration shown below is capable of delivering better than 97dB SNR and -103db THD at an input frequency of 100 kHz. In case band-pass filters are used to filter the input, care should be taken to ensure that the signal swing at the input of the band-pass filter is small so as to keep the distortion introduced by the filter minimal. In such cases, the gain of the circuit shown below can be increased to keep the input to the ADS8482 large to keep the SNR of the system high. Note that the gain of the system from the + input to the output of the THS4031 in such a configuration is a function of the gain of the AC signal. A resistor divider can be used to scale the output of the REF3220 or REF3240 to reduce the voltage at the DC input to THS4031 to keep the voltage at the input of the converter within its rated operating range.

PRINCIPLES OF OPERATION (continued)

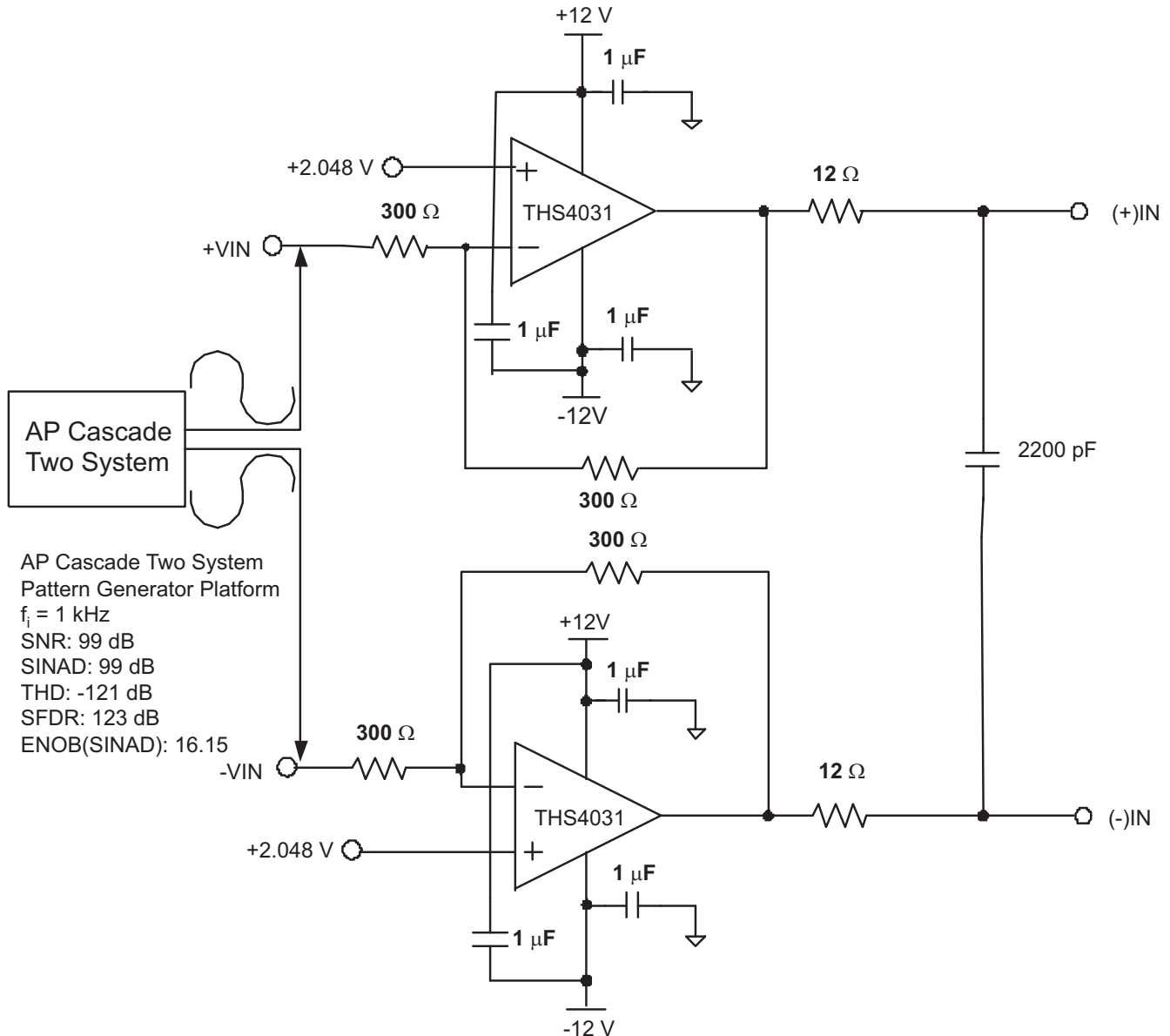

Figure 40. Differential Input, Differential Output Configuration

DIGITAL INTERFACE

Timing and Control

See the timing diagrams in the specifications section for detailed information on timing signals and their requirements.

The ADS8482 uses an internal oscillator generated clock which controls the conversion rate and in turn the throughput of the converter. No external clock input is required.

PRINCIPLES OF OPERATION (continued)

Conversions are initiated by bringing the $\overline{\text{CONVST}}$ pin low for a minimum of 20 ns (after the 20 ns minimum requirement has been met, the $\overline{\text{CONVST}}$ pin can be brought high), while $\overline{\text{CS}}$ is low. The ADS8482 switches from the sample to the hold mode on the falling edge of the $\overline{\text{CONVST}}$ command. A clean and low jitter falling edge of this signal is important to the performance of the converter. The BUSY output is brought high immediately following $\overline{\text{CONVST}}$ going low. BUSY stays high throughout the conversion process and returns low when the conversion has ended.

Sampling starts with the falling edge of the BUSY signal when $\overline{\text{CS}}$ is tied low or starts with the falling edge of $\overline{\text{CS}}$ when BUSY is low.

Both $\overline{\text{RD}}$ and $\overline{\text{CS}}$ can be high during and before a conversion with one exception ($\overline{\text{CS}}$ must be low when $\overline{\text{CONVST}}$ goes low to initiate a conversion). Both the $\overline{\text{RD}}$ and $\overline{\text{CS}}$ pins are brought low in order to enable the parallel output bus with the conversion.

Reading Data

The ADS8482 outputs full parallel data in straight binary format as shown in Table 1. The parallel output is active when $\overline{\text{CS}}$ and $\overline{\text{RD}}$ are both low. There is a minimal quiet zone requirement around the falling edge of $\overline{\text{CONVST}}$. This is 50 ns prior to the falling edge of $\overline{\text{CONVST}}$ and 40 ns after the falling edge. No data read should attempted within this zone. Any other combination of $\overline{\text{CS}}$ and $\overline{\text{RD}}$ sets the parallel output to 3-state. BYTE and BUS18/16 are used for multiword read operations. BYTE is used whenever lower bits on the bus are output on the higher byte of the bus. BUS18/16 is used whenever the last two bits on the 18-bit bus is output on either bytes of the higher 16-bit bus. Refer to Table 1 for ideal output codes.

Table 1. Ideal Input Voltages and Output Codes

DESCRIPTION	ANALOG VALUE	DIGITAL OUTPUT STRAIGHT BINARY	
		BINARY CODE	HEX CODE
Full scale range	+V _{ref}		
Least significant bit (LSB)	$2 \times (+V_{ref})/262144$		
+Full scale	$(+V_{ref}) - 1 \text{ LSB}$	01 1111 1111 1111 1111	1FFFF
Midscale	0 V	00 0000 0000 0000 0000	00000
Midscale - 1 LSB	0 V - 1 LSB	11 1111 1111 1111 1111	3FFFF
Zero	-V _{ref}	10 0000 0000 0000 0000	20000

The output data is a full 18-bit word (D17–D0) on DB17–DB0 pins (MSB–LSB) if both BUS18/16 and BYTE are low.

The result may also be read on an 16-bit bus by using only pins DB17–DB2. In this case two reads are necessary: the first as before, leaving both BUS18/16 and BYTE low and reading the 16 most significant bits (D17–D2) on pins DB17–DB2, then bringing BUS18/16 high while holding BYTE low. When BUS18/16 is high, the lower two bits (D1–D0) appear on pins DB3–DB2.

The result may also be read on an 8-bit bus for convenience. This is done by using only pins DB17–DB10. In this case three reads are necessary: the first as before, leaving both BUS18/16 and BYTE low and reading the 8 most significant bits on pins DB17–DB10, then bringing BYTE high while holding BUS18/16 low. When BYTE is high, the medium bits (D9–D2) appear on pins DB17–DB10. The last read is done by bringing BUS18/16 high while holding BYTE high. When BUS18/16 is high, the lower two bits (D1–D0) appear on pins DB11–DB10. The last read cycle is not necessary if only the first 16 most significant bits are of interest.

All of these multiword read operations can be performed with multiple active $\overline{\text{RD}}$ (toggling) or with $\overline{\text{RD}}$ held low for simplicity. This is referred to as the AUTO READ operation.

Table 2. Conversion Data Read Out

BYTE	BUS18/16	DATA READ OUT				
		PINS DB17–DB12	PINS DB11–DB10	PINS DB9–DB4	PINS DB3–DB2	PINS DB1–DB0
High	High	All One's	D1–D0	All One's	All One's	All One's
Low	High	All One's	All One's	All One's	D1–D0	All One's

Table 2. Conversion Data Read Out (continued)

BYTE	BUS18/ $\overline{16}$	DATA READ OUT				
		PINS DB17–DB12	PINS DB11–DB10	PINS DB9–DB4	PINS DB3–DB2	PINS DB1–DB0
High	Low	D9–D4	D3–D2	All One's	All One's	All One's
Low	Low	D17–D12	D11–D10	D9–D4	D3–D2	D1–D0

RESET

On power-up, internal POWER-ON RESET circuitry generates the reset required for the device. The first three conversions after power-up are used to load factory trimming data for a specific device to assure high accuracy of the converter. The results of the first three conversions are invalid and should be discarded.

The device can also be reset through the use of the combination for \overline{CS} and \overline{CONVST} . Since the BUSY signal is held at high during the conversion, either one of these conditions triggers an internal self-clear reset to the converter.

- Issue a \overline{CONVST} when \overline{CS} is low and the internal convert state is high. The falling edge of \overline{CONVST} starts a reset.
- Issue a \overline{CS} (select the device) while the internal convert state is high. The falling edge of \overline{CS} causes a reset.

Once the device is reset, all output latches are cleared (set to zeroes) and the BUSY signal is brought low. A new sampling period is started at the falling edge of the BUSY signal immediately after the instant of the internal reset.

LAYOUT

For optimum performance, care must be taken with the physical layout of the ADS8482 circuitry.

As the ADS8482 offers single-supply operation, it is often used in close proximity with digital logic, microcontrollers, microprocessors, and digital signal processors. The more digital logic present in the design and the higher the switching speed, the more difficult it is to achieve good performance from the converter.

The basic SAR architecture is sensitive to glitches or sudden changes on the power supply, reference, ground connections and digital inputs that occur just prior to latching the output of the analog comparator. Thus, driving any single conversion for an n-bit SAR converter, there are at least n windows in which large external transient voltages can affect the conversion result. Such glitches might originate from switching power supplies, nearby digital logic, or high power devices.

The degree of error in the digital output depends on the reference voltage, layout, and the exact timing of the external event.

On average, the ADS8482 draws very little current from an external reference as the reference voltage is internally buffered. If the reference voltage is external and originates from an op amp, make sure that it can drive the bypass capacitor or capacitors without oscillation. A 0.1- μ F capacitor is recommended from pin 13 (REFIN) directly to pin 12 (REFM). REFM and AGND must be shorted on the same ground plane under the device.

The AGND and BDGND pins should be connected to a clean ground point. In all cases, this should be the analog ground. Avoid connections which are too close to the grounding point of a microcontroller or digital signal processor. If required, run a ground trace directly from the converter to the power supply entry point. The ideal layout consists of an analog ground plane dedicated to the converter and associated analog circuitry.

As with the AGND connections, +VA should be connected to a 5-V power supply plane or trace that is separate from the connection for digital logic until they are connected at the power entry point. Power to the ADS8482 should be clean and well bypassed. A 0.1- μ F ceramic bypass capacitor should be placed as close to the device as possible. See [Table 3](#) for the placement of the capacitor. In addition, a 1- μ F to 10- μ F capacitor is recommended. In some situations, additional bypassing may be required, such as a 100- μ F electrolytic capacitor or even a Pi filter made up of inductors and capacitors—all designed to essentially low-pass filter the 5-V supply, removing the high frequency noise.

Table 3. Power Supply Decoupling Capacitor Placement

POWER SUPPLY PLANE	CONVERTER ANALOG SIDE	CONVERTER DIGITAL SIDE
SUPPLY PINS		
Pin pairs that require shortest path to decoupling capacitors	(7,8), (9,10), (16,17), (20,21), (22,23), (25,26)	(36,37)
Pins that require no decoupling	24, 26	1

PACKAGING INFORMATION

Orderable Device	Status ⁽¹⁾	Package Type	Package Drawing	Pins	Package Qty	Eco Plan ⁽²⁾	Lead/Ball Finish	MSL Peak Temp ⁽³⁾
ADS8482IBRGZR	ACTIVE	QFN	RGZ	48	1000	Green (RoHS & no Sb/Br)	CU NIPDAU	Level-2-260C-1 YEAR
ADS8482IBRGZRG4	ACTIVE	QFN	RGZ	48	1000	Green (RoHS & no Sb/Br)	CU NIPDAU	Level-2-260C-1 YEAR
ADS8482IBRGZT	ACTIVE	QFN	RGZ	48	250	Green (RoHS & no Sb/Br)	CU NIPDAU	Level-2-260C-1 YEAR
ADS8482IBRGZTG4	ACTIVE	QFN	RGZ	48	250	Green (RoHS & no Sb/Br)	CU NIPDAU	Level-2-260C-1 YEAR
ADS8482IRGZR	ACTIVE	QFN	RGZ	48	1000	Green (RoHS & no Sb/Br)	CU NIPDAU	Level-2-260C-1 YEAR
ADS8482IRGZRG4	ACTIVE	QFN	RGZ	48	1000	Green (RoHS & no Sb/Br)	CU NIPDAU	Level-2-260C-1 YEAR
ADS8482IRGZT	ACTIVE	QFN	RGZ	48	250	Green (RoHS & no Sb/Br)	CU NIPDAU	Level-2-260C-1 YEAR
ADS8482IRGZTG4	ACTIVE	QFN	RGZ	48	250	Green (RoHS & no Sb/Br)	CU NIPDAU	Level-2-260C-1 YEAR

⁽¹⁾ The marketing status values are defined as follows:

ACTIVE: Product device recommended for new designs.

LIFEBUY: TI has announced that the device will be discontinued, and a lifetime-buy period is in effect.

NRND: Not recommended for new designs. Device is in production to support existing customers, but TI does not recommend using this part in a new design.

PREVIEW: Device has been announced but is not in production. Samples may or may not be available.

OBSOLETE: TI has discontinued the production of the device.

⁽²⁾ Eco Plan - The planned eco-friendly classification: Pb-Free (RoHS), Pb-Free (RoHS Exempt), or Green (RoHS & no Sb/Br) - please check <http://www.ti.com/productcontent> for the latest availability information and additional product content details.

TBD: The Pb-Free/Green conversion plan has not been defined.

Pb-Free (RoHS): TI's terms "Lead-Free" or "Pb-Free" mean semiconductor products that are compatible with the current RoHS requirements for all 6 substances, including the requirement that lead not exceed 0.1% by weight in homogeneous materials. Where designed to be soldered at high temperatures, TI Pb-Free products are suitable for use in specified lead-free processes.

Pb-Free (RoHS Exempt): This component has a RoHS exemption for either 1) lead-based flip-chip solder bumps used between the die and package, or 2) lead-based die adhesive used between the die and leadframe. The component is otherwise considered Pb-Free (RoHS compatible) as defined above.

Green (RoHS & no Sb/Br): TI defines "Green" to mean Pb-Free (RoHS compatible), and free of Bromine (Br) and Antimony (Sb) based flame retardants (Br or Sb do not exceed 0.1% by weight in homogeneous material)

⁽³⁾ MSL, Peak Temp. -- The Moisture Sensitivity Level rating according to the JEDEC industry standard classifications, and peak solder temperature.

Important Information and Disclaimer:The information provided on this page represents TI's knowledge and belief as of the date that it is provided. TI bases its knowledge and belief on information provided by third parties, and makes no representation or warranty as to the accuracy of such information. Efforts are underway to better integrate information from third parties. TI has taken and continues to take reasonable steps to provide representative and accurate information but may not have conducted destructive testing or chemical analysis on incoming materials and chemicals. TI and TI suppliers consider certain information to be proprietary, and thus CAS numbers and other limited information may not be available for release.

In no event shall TI's liability arising out of such information exceed the total purchase price of the TI part(s) at issue in this document sold by TI to Customer on an annual basis.

RGZ (S-PQFP-N48)

PLASTIC QUAD FLATPACK

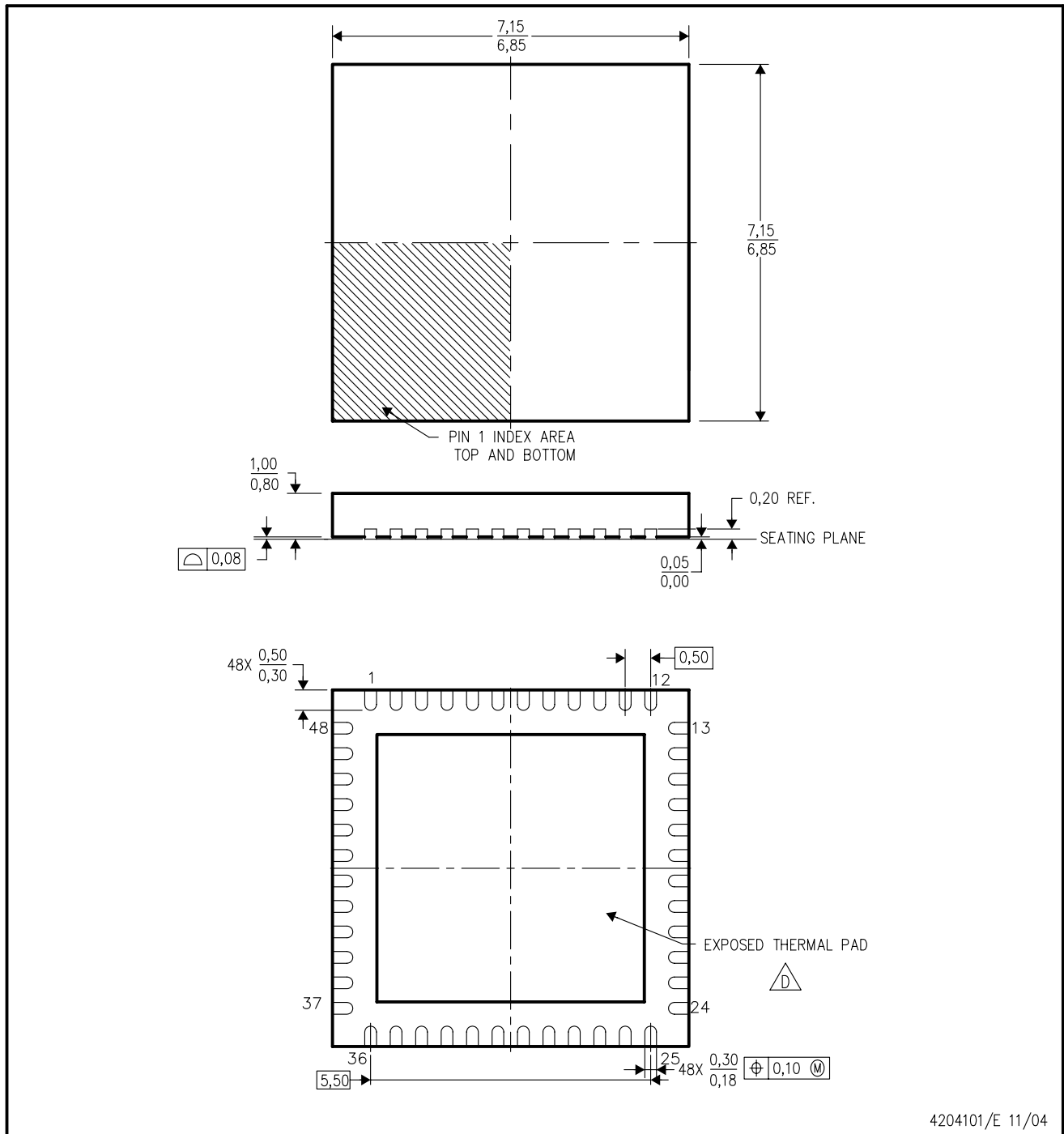

4204101/E 11/04

- NOTES:
- A. All linear dimensions are in millimeters. Dimensioning and tolerancing per ASME Y14.5M-1994.
 - B. This drawing is subject to change without notice.
 - C. Quad Flatpack, No-leads (QFN) package configuration.
 -  The package thermal pad must be soldered to the board for thermal and mechanical performance. See the Product Data Sheet for details regarding the exposed thermal pad dimensions.
 - E. Falls within JEDEC MO-220.

THERMAL INFORMATION

This package incorporates an exposed thermal pad that is designed to be attached directly to an external heatsink. The thermal pad must be soldered directly to the printed circuit board (PCB). After soldering, the PCB can be used as a heatsink. In addition, through the use of thermal vias, the thermal pad can be attached directly to a ground or power plane (whichever is applicable), or alternatively, a special heatsink structure designed into the PCB. This design optimizes the heat transfer from the integrated circuit (IC).

For information on the Quad Flatpack No-Lead (QFN) package and its advantages, refer to Application Report, Quad Flatpack No-Lead Logic Packages, Texas Instruments Literature No. SCBA017. This document is available at www.ti.com.

The exposed thermal pad dimensions for this package are shown in the following illustration.

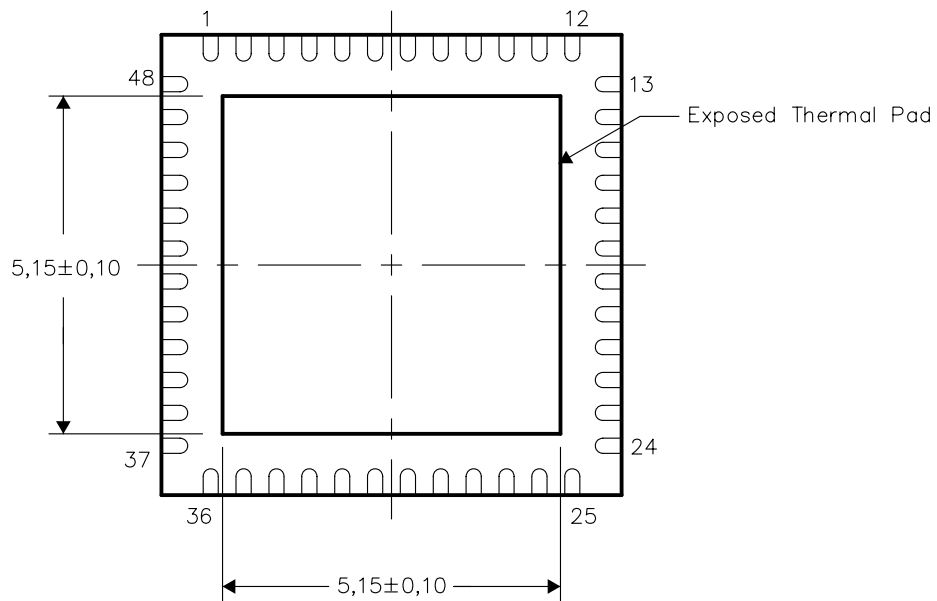

Bottom View

NOTE: All linear dimensions are in millimeters

Exposed Thermal Pad Dimensions

RGZ (S-PQFP-N48)

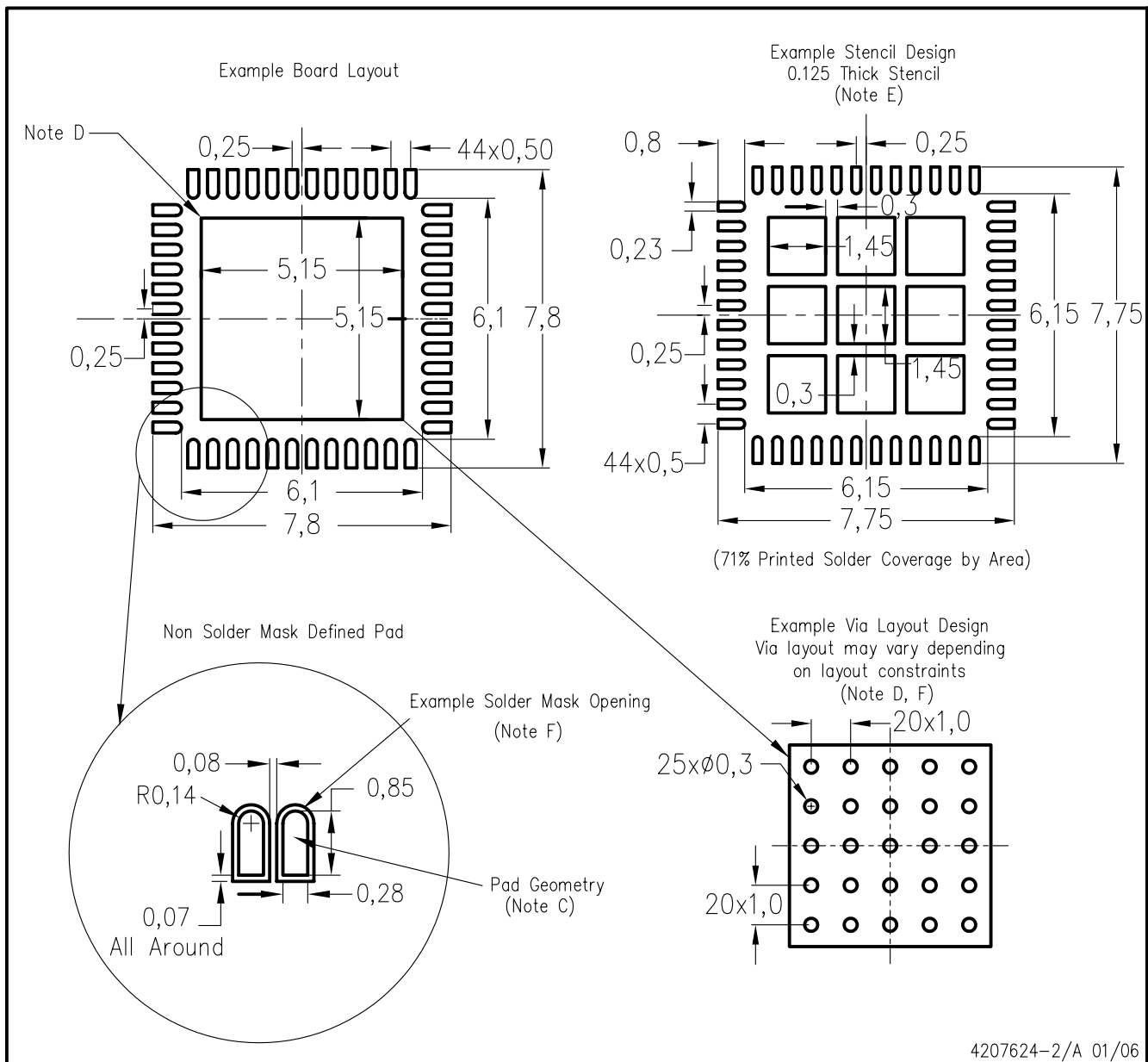

- NOTES:
- All linear dimensions are in millimeters.
 - This drawing is subject to change without notice.
 - Publication IPC-7351 is recommended for alternate designs.
 - This package is designed to be soldered to a thermal pad on the board. Refer to Application Note, Quad Flat-Pack Packages, Texas Instruments Literature No. SCBA017, SLUA271, and also the Product Data Sheets for specific thermal information, via requirements, and recommended board layout. These documents are available at www.ti.com <<http://www.ti.com>>.
 - Laser cutting apertures with trapezoidal walls and also rounding corners will offer better paste release. Customers should contact their board assembly site for stencil design recommendations. Refer to IPC 7525 for stencil design considerations.
 - Customers should contact their board fabrication site for recommended solder mask tolerances and via tenting recommendations for vias placed in the thermal pad.

IMPORTANT NOTICE

Texas Instruments Incorporated and its subsidiaries (TI) reserve the right to make corrections, modifications, enhancements, improvements, and other changes to its products and services at any time and to discontinue any product or service without notice. Customers should obtain the latest relevant information before placing orders and should verify that such information is current and complete. All products are sold subject to TI's terms and conditions of sale supplied at the time of order acknowledgment.

TI warrants performance of its hardware products to the specifications applicable at the time of sale in accordance with TI's standard warranty. Testing and other quality control techniques are used to the extent TI deems necessary to support this warranty. Except where mandated by government requirements, testing of all parameters of each product is not necessarily performed.

TI assumes no liability for applications assistance or customer product design. Customers are responsible for their products and applications using TI components. To minimize the risks associated with customer products and applications, customers should provide adequate design and operating safeguards.

TI does not warrant or represent that any license, either express or implied, is granted under any TI patent right, copyright, mask work right, or other TI intellectual property right relating to any combination, machine, or process in which TI products or services are used. Information published by TI regarding third-party products or services does not constitute a license from TI to use such products or services or a warranty or endorsement thereof. Use of such information may require a license from a third party under the patents or other intellectual property of the third party, or a license from TI under the patents or other intellectual property of TI.

Reproduction of information in TI data books or data sheets is permissible only if reproduction is without alteration and is accompanied by all associated warranties, conditions, limitations, and notices. Reproduction of this information with alteration is an unfair and deceptive business practice. TI is not responsible or liable for such altered documentation.

Resale of TI products or services with statements different from or beyond the parameters stated by TI for that product or service voids all express and any implied warranties for the associated TI product or service and is an unfair and deceptive business practice. TI is not responsible or liable for any such statements.

Following are URLs where you can obtain information on other Texas Instruments products and application solutions:

Products

Amplifiers	amplifier.ti.com
Data Converters	dataconverter.ti.com
DSP	dsp.ti.com
Interface	interface.ti.com
Logic	logic.ti.com
Power Mgmt	power.ti.com
Microcontrollers	microcontroller.ti.com
Low Power Wireless	www.ti.com/lpw

Applications

Audio	www.ti.com/audio
Automotive	www.ti.com/automotive
Broadband	www.ti.com/broadband
Digital Control	www.ti.com/digitalcontrol
Military	www.ti.com/military
Optical Networking	www.ti.com/opticalnetwork
Security	www.ti.com/security
Telephony	www.ti.com/telephony
Video & Imaging	www.ti.com/video
Wireless	www.ti.com/wireless

Mailing Address: Texas Instruments
Post Office Box 655303 Dallas, Texas 75265