



Features

- Input Voltage Range: 36V to 75V
- 35W Output Power
- 90% Efficiency
- 1500 VDC Isolation
- Low Profile (8 mm)
- Adjustable Output Voltage
- Dual-Logic On/Off Enable
- Power-Up Sequence Control
- Differential Remote Sense
- Over-Current Protection
- Space Saving Package
- Solderable Copper Case
- Safety Approvals Pending

Description

The PT3400 Excalibur™ power modules are a series of 35-W rated DC/DC converters housed in a low-profile space-saving copper case. Fully isolated for telecom applications, the series includes a number of standard voltages, including 1.0 VDC. Other applications include industrial, high-end computing, and other distributed power applications that require input-to-output isolation.

PT3400 modules incorporate a feature that simplifies the design of multiple voltage power supplies in DSP and ASIC applications. Using the SEQ control pin, the output voltage of two PT3400 modules in a power supply system can be made to self sequence at power-up. Other features include output voltage adjust, over-current protection, input under-voltage lockout, and a differential remote sense to compensate for any voltage drop between the converter and load.

Ordering Information

PT3401□	= 3.3V/10A	(33W)
PT3402□	= 2.5V/12A	(30W)
PT3403□	= 1.8V/12A	(21.6W)
PT3404□	= 1.5V/16A	(24W)
PT3405□	= 1.4V/16A	(22.4W)
PT3406□	= 1.2V/16A	(19.2W)
PT3407□	= 1V/16A	(16W)
PT3408□	= 5V/7A	(35W)

PT Series Suffix (PT1234x)

Case/Pin Configuration	Order Suffix	Package Code
Vertical	N	(EPL)
Horizontal	A	(EPM)
SMD	C	(EPN)

(Reference the applicable package code drawing for the dimensions and PC board layout)

Pin-Out Information

Pin	Function
1	EN 1
2	EN 2*
3	-V _{in}
4	+V _{in}
5	SEQ
6	V _{out} Adj
7	-V _{sense}
8	-V _{out}
9	-V _{out}
10	-V _{out}
11	+V _{out}
12	+V _{out}
13	+V _{out}
14	+V _{sense}

* Negative logic

Shaded functions indicate those pins that are referenced to -V_{in}.

Standard Application

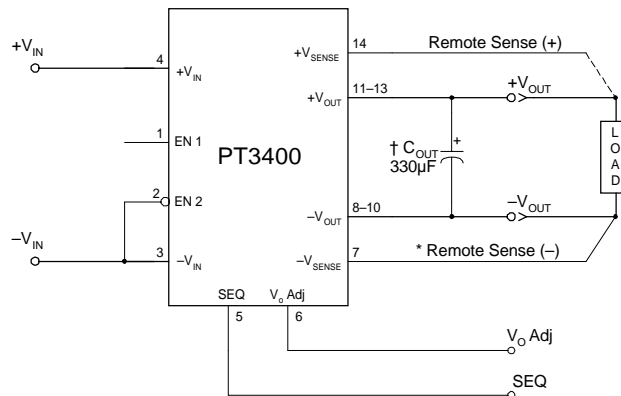

† An output capacitor is required on models with an output voltage less than 2.5V.

* -V_{sense} (pin 7) must be connected to -V_{out}, either at the load or directly to pin 8 of the converter.

Specifications (Unless otherwise stated, $T_a = 25^\circ\text{C}$, $V_{in} = 48\text{V}$, $C_{in} = 0\mu\text{F}$, $I_o = I_{o,max}$, and C_{out} as required)

Characteristic	Symbol	Conditions	PT3400 Series			Units	
			Min	Typ	Max		
Output Current	I_o	Over V_{in} range	$V_o \leq 1.5\text{V}$	0	—	16	A
			$V_o = 1.8\text{V}/2.5\text{V}$	0	—	12	
			$V_o = 3.3\text{V}$	0	—	10	
			$V_o = 5\text{V}$	0	—	7	
Input Voltage Range	V_{in}	Over I_o Range	36	48	75	VDC	
Set Point Voltage Tolerance	$V_o\text{tol}$		—	± 1	± 2	$\%V_o$	
Temperature Variation	Reg_{temp}	$-40^\circ \leq T_a \leq +85^\circ\text{C}$, $I_o = I_{o,min}$	—	± 0.8	—	$\%V_o$	
Line Regulation	Reg_{line}	Over V_{in} range	$V_o = 5.0\text{V}$	—	± 5	± 20	mV
			$V_o \leq 3.3\text{V}$	—	± 5	± 15	mV
Load Regulation	Reg_{load}	Over I_o range	$V_o = 5.0\text{V}$	—	± 1	± 15 (1)	mV
			$V_o \leq 3.3\text{V}$	—	± 1	± 10 (1)	mV
Total Output Voltage Variation	$\Delta V_{o,tot}$	Includes set-point, line, load, $-40^\circ \leq T_a \leq +85^\circ\text{C}$	—	± 2	± 3	$\%V_o$	
Efficiency	η	$I_o = 70\%$ of $I_{o,max}$	$V_o = 5\text{V}$	—	91	—	%
			$V_o = 3.3\text{V}$	—	90	—	
			$V_o = 2.5\text{V}$	—	89	—	
			$V_o = 1.8\text{V}$	—	85	—	
			$V_o = 1.5\text{V}$	—	84	—	
			$V_o = 1.4\text{V}$	—	84	—	
			$V_o = 1.2\text{V}$	—	82	—	
V_o Ripple (pk-pk)	V_r	20MHz bandwidth	$V_o \geq 3.3\text{V}$	—	50	—	mV _{pp}
			$V_o \leq 2.5\text{V}$	—	25	—	
Transient Response	t_{tr}	0.1A/ μs load step, 50% to 75% $I_{o,max}$	—	100	—	μs	
	ΔV_{tr}	V_o over/undershoot	—	± 4	—	$\%V_o$	
Output Adjust	V_{adj}		$V_o \geq 2.5\text{V}$	-5	—	+5	$\%V_o$
			$V_o \leq 1.8\text{V}$	-0	—	+10	
Over-Current Threshold	I_{TRIP}	$V_{in} = 36\text{V}$	$V_o = 5.0\text{V}$	—	9	—	A
			$V_o = 3.3\text{V}$	—	12.5	—	
			$V_o = 2.5\text{V}/1.8\text{V}$	—	16	—	
			$V_o \leq 1.5\text{V}$	—	20	—	
Switching Frequency	f_s	Over V_{in} range	250	300	350	kHz	
Under-Voltage Lockout	UVLO	Rising	—	34	—	V	
		Falling	—	32	—		
Enable On/Off (Pins 1, 2) Input High Voltage Input Low Voltage Input Low Current	V_{IH}	Referenced to $-V_{in}$ (pin 3)	5	—	Open (2)	V	
	V_{IL}		-0.3	—	+0.4		
	I_{IL}		—	0.5	—		mA
Standby Input Current	$I_{in, standby}$	pins 1 & 3 connected	—	5	—	mA	
Internal Input Capacitance	C_{in}		—	1.0	—	μF	
External Output Capacitance	C_{out}	$V_o = 1.0\text{V}$	470 (3)	—	TBD	μF	
		$V_o \leq 1.8\text{V}$	330 (3)	—	TBD		
		$V_o \geq 2.5\text{V}$	0	—	TBD		
Isolation Voltage Capacitance Resistance		Input-output/input-case	1500	—	—	V	
		Input to output	—	1500	—	pF	
		Input to output	10	—	—	M Ω	
Operating Temperature Range	T_a	Over V_{in} range	-40 (4)	—	85 (5)	$^\circ\text{C}$	
Solder Reflow Temperature	T_{reflow}	Surface temperature of module pins or case	—	—	215 (6)	$^\circ\text{C}$	
Storage Temperature	T_s	—	-40	—	125	$^\circ\text{C}$	
Reliability	MTBF	Per Bellcore TR-332 50% stress, $T_a = 40^\circ\text{C}$, ground benign	2.8	—	—	10^6 Hrs	
Mechanical Shock	—	Per Mil-Std-883D, method 2002.3, 1mS, half-sine, mounted to a fixture	—	TBD	—	G's	
Mechanical Vibration	—	Mil-Std-883D, Method 2007.2, 20-2000Hz, PCB mounted	Vertical	—	TBD (7)	—	G's
			Horizontal	—	TBD (7)	—	
Weight	—	—	—	34	—	grams	
Flammability	—	Materials meet UL 94V-0	—	—	—	—	

- Notes:**
- (1) If the remote sense feature is not being used, $-V_{sense}$ (pin 7) must be connected to $-V_{out}$ (pin 8).
 - (2) The On/Off Enable inputs (pins 1 & 2) have internal pull-ups. They may either be connected to $-V_{in}$ or left open circuit. Leaving pin 1 open-circuit and connecting pin 2 to $-V_{in}$ allows the the converter to operate when input power is applied. The maximum open-circuit voltage of the Enable pins is 10V.
 - (3) An output capacitor is required for proper operation for all models in which the output voltage is 1.8VDC or less. For models with an output voltage of 2.5V or higher an output capacitor is optional.
 - (4) For operation below 0°C , C_{out} must have stable characteristics. Use low ESR tantalum capacitors, or capacitors with a polymer type dielectric.
 - (5) See Safe Operating Area curves or contact the factory for the appropriate derating.
 - (6) During reflow of SMD package version do not elevate the module case, pins, or internal component temperatures above a peak of 215°C . For further guidance refer to the application note, "Reflow Soldering Requirements for Plug-in Surface Mount Products," (SLTA051).
 - (7) The case pins on through-hole pin configurations (N & A) must be soldered. For more information see the applicable package outline drawing.

PT3408, 5VDC (See Note A)

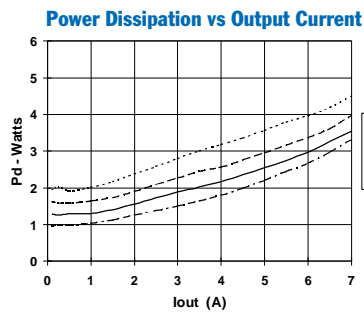
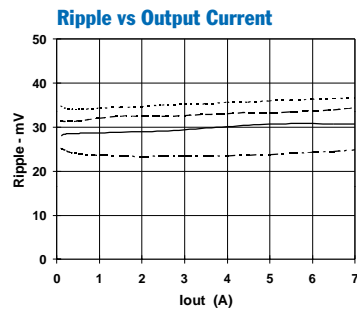
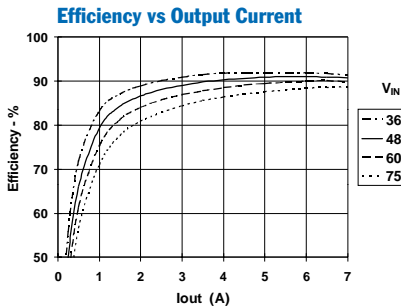

Safe Operating Area (See Note B)

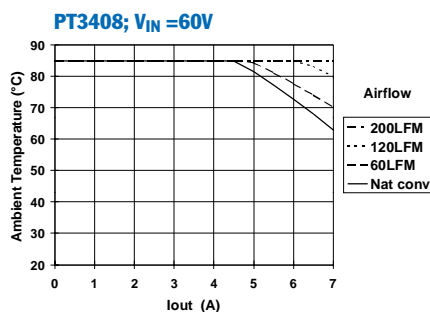

PT3401, 3.3 VDC (See Note A)

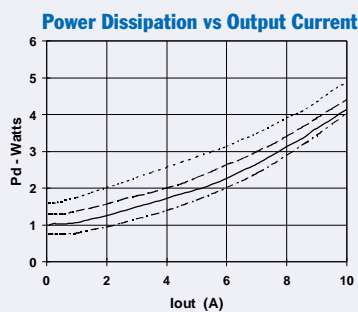
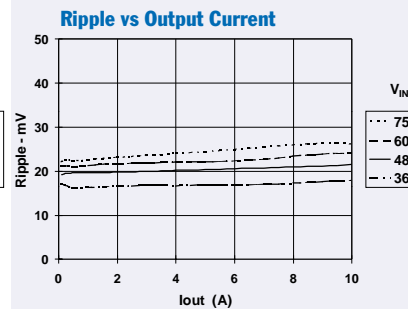
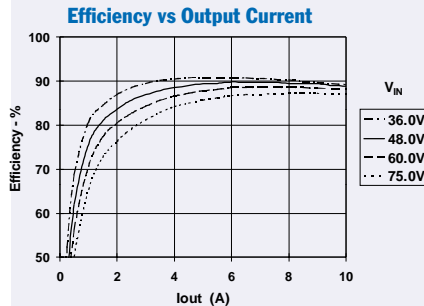

Safe Operating Area (See Note B)

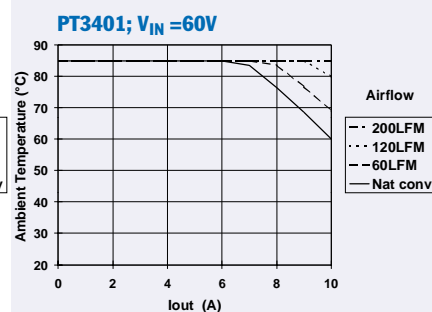

PT3402, 2.5 VDC (See Note A)

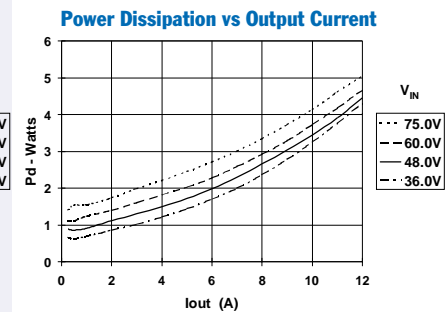
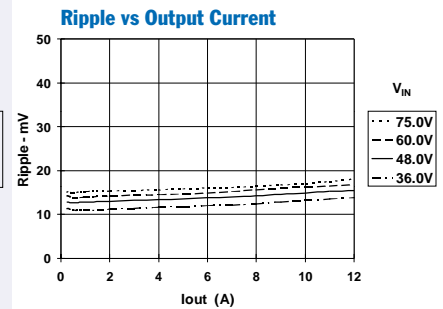
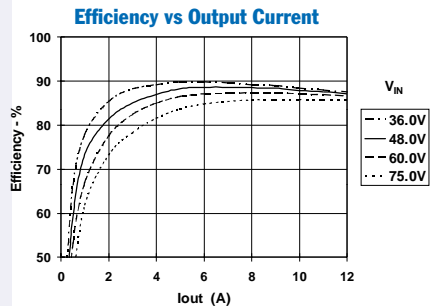

Safe Operating Area (See Note B)

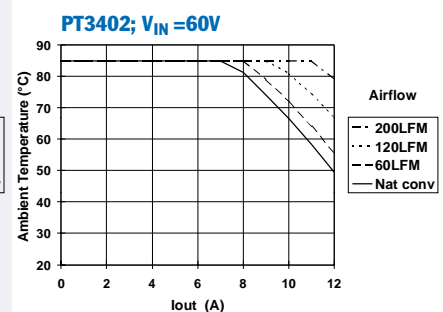

Note A: Characteristic data has been developed from actual products tested at 25°C. This data is considered typical data for the Converter.

Note B: SOA curves represent the conditions at which internal components are at or below the manufacturer's maximum operating temperatures

PT3403, 1.8 VDC (See Note A)

PT3404/5, 1.5/1.4 VDC (See Note A)

PT3406, 1.2 VDC (See Note A)

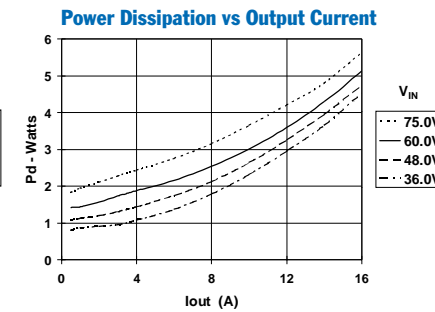
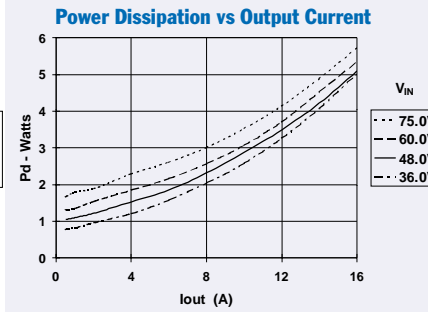
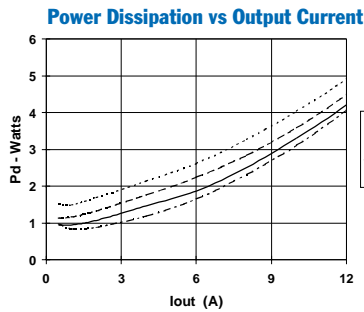
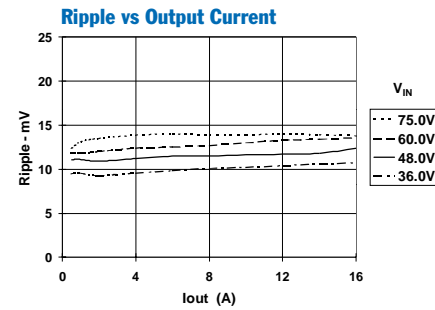
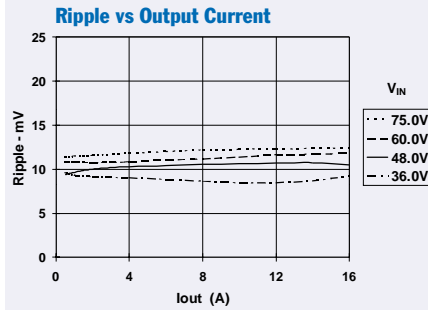
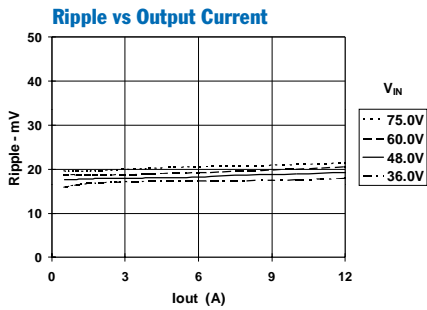
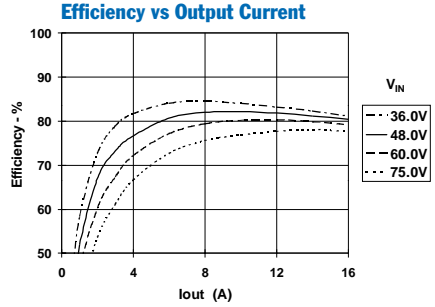
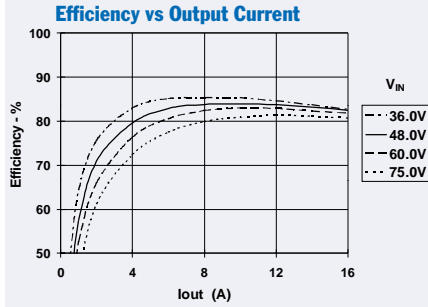
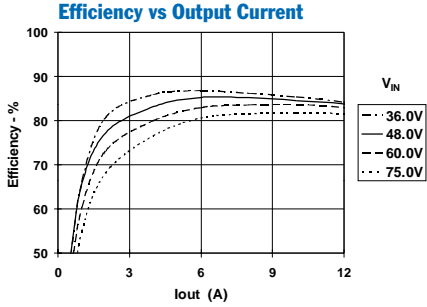

Safe Operating Area (See Note B)

Safe Operating Area (See Note B)

Safe Operating Area (See Note B)

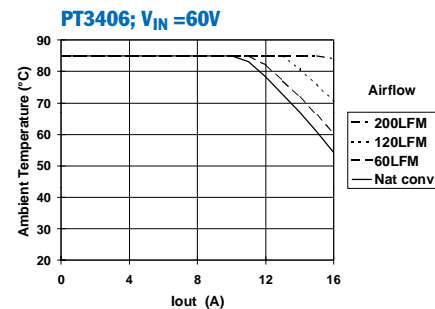
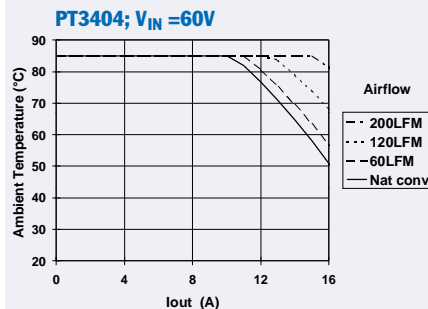
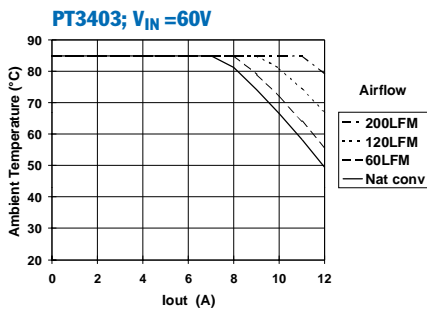

Note A: Characteristic data has been developed from actual products tested at 25°C. This data is considered typical data for the Converter.

Note B: SOA curves represent the conditions at which internal components are at or below the manufacturer's maximum operating temperatures

PT3407, 1.0 VDC (See Note A)

Efficiency vs Output Current

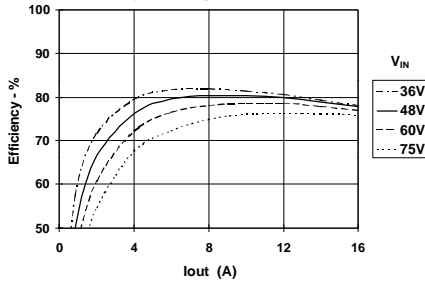

Ripple vs Output Current

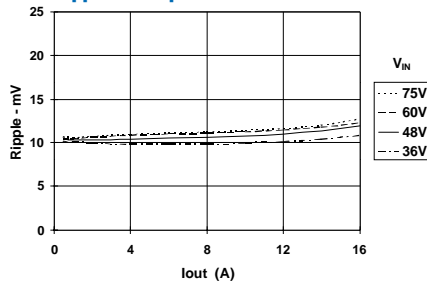

Power Dissipation vs Output Current

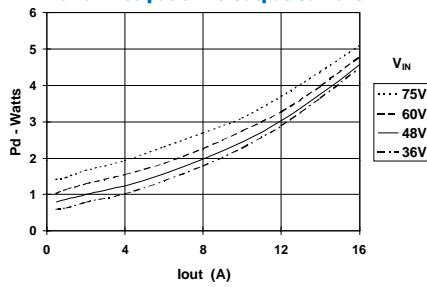

Safe Operating Area (See Note B)

PT3406; V_{IN} = 60V

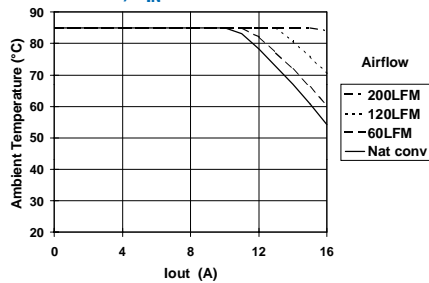

Note A: Characteristic data has been developed from actual products tested at 25°C. This data is considered typical data for the Converter.

Note B: SOA curves represent the conditions at which internal components are at or below the manufacturer's maximum operating temperatures

Operating Features of the PT3400 Series of Isolated DC/DC Converters

Under-Voltage Lockout

An Under-Voltage Lock-Out (UVLO) inhibits the operation of the converter until the input voltage is above the UVLO threshold (see the data sheet specification). Below this voltage, the module's output is held off, irrespective of the state of either the $EN1$ & $EN2$ enable controls. The UVLO allows the module to produce a clean transition during both power-up and power-down, even when the input voltage is rising or falling slowly. It also reduces the high start-up current during normal power-up of the converter, and minimizes the current drain from the input source during low-input voltage conditions. The UVLO threshold includes about 1V of hysteresis.

If $EN2$ (pin 2) is connected to $-V_{in}$ (pin 3) and $EN1$ (pin 1) is left open, the module will automatically power up when the input voltage rises above the UVLO threshold (see data sheet 'Standard Application' schematic). Once operational, the converter will conform to its operating specifications when the minimum specified input voltage is reached.

Over-Current Protection

To protect against load faults, the PT3400 series incorporates output over-current protection. Applying a load that exceeds the converter's over-current threshold (see applicable specification) will cause the regulated output to shut down. Following shutdown the module will periodically attempt to automatically recover by initiating a soft-start power-up. This is often described as a "hiccup" mode of operation, whereby the module continues in the cycle of successive shutdown and power up until the load fault is removed. Once the fault is removed, the converter then automatically recovers and returns to normal operation.

Primary-Secondary Isolation

Electrical isolation is provided between the input terminals (primary) and the output terminals (secondary). All converters are production tested to a primary-secondary withstand voltage of 1500VDC. This specification complies with UL60950 and EN60950 and the requirements for operational isolation. Operational isolation allows these converters to be configured for either a positive or negative input voltage source. The data sheet 'Pin-Out Information' uses shading to indicate which pins are associated with the primary. They include pins 1 through 4, inclusive.

Input Current Limiting

The converter is not internally fused. For safety and overall system protection, the maximum input current to the converter must be limited. Active or passive current limiting can be used. Passive current limiting can be a fast acting fuse. A 125-V fuse, rated no more than 5A, is recommended. Active current limiting can be implemented with a current limited "Hot-Swap" controller.

Thermal Considerations

Airflow may be necessary to ensure that the module can supply the desired load current in environments with elevated ambient temperatures. The required airflow rate may be determined from the Safe Operating Area (SOA) thermal derating chart (see converter specifications). The recommended direction for airflow is into the longest side of the module's metal case. See Figure 1-1.

Figure 1-1

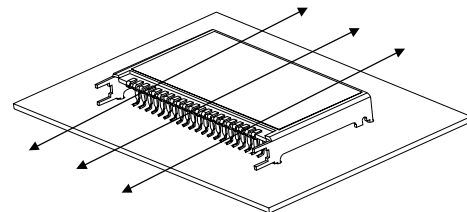

Recommended direction for airflow is into (perpendicular to) the longest side

Adjusting the Output Voltage of the 30W-Rated PT3400 Series of Isolated DC/DC Converters

The output voltage of the PT3400 Excalibur™ series of isolated DC/DC converters may be adjusted over a limited range from the factory-trimmed nominal value. Adjustment is accomplished with a single external resistor. The placement the resistor determines the direction of adjustment, either up or down, and the value of the resistor the magnitude of adjustment. Table 3-1 gives the allowable adjustment range for each model in the series as V_a (min) and V_a (max) respectively. Note that converters with an output voltage of 1.8V or less can only be adjusted up 1.

Adjust Up: An increase in the output voltage is obtained by adding a resistor, R_1 between $V_o Adj$ (pin 6), and $-V_{sense}$ (pin 7).

Adjust Down (PT3401, PT3402, & PT3408 Only): Add a resistor (R_2), between $V_o Adj$ (pin 6) and $+V_{sense}$ (pin 14).

Refer to Figure 3-1 and Table 3-2 for both the placement and value of the required resistor, R_1 or (R_2).

The values of R_1 [adjust up], and (R_2) [adjust down], can also be calculated using the following formulas.

$$R_1 = \frac{2 \cdot R_o}{V_a - V_o} - R_s \quad \text{k}\Omega$$

$$(R_2) = \frac{R_o (V_a - 2)}{V_o - V_a} - R_s \quad \text{k}\Omega$$

Where, V_a = Adjusted output voltage
 V_o = Original output voltage
 R_o = Resistor constant in Table 3-1
 R_s = Internal series resistance in Table 3-1

Notes:

1. The output voltage of the PT3401 (3.3V), PT3402 (2.5V), and PT3408 (5V) may be adjusted either higher or lower. All other models, which have an output voltage of 1.8V or less, can only be adjusted higher.
2. Use only a single 1% resistor in either the R_1 or (R_2) location. Place the resistor as close to the converter as possible.
3. Never connect capacitors to $V_o Adj$. Any capacitance added to this pin will affect the stability of the converter.
4. If the output voltage is increased, the maximum load current must be derated according to the following equation.

$$I_o(\text{max}) = \frac{V_o \times I_o(\text{rated})}{V_a}$$

In any instance, the load current must not exceed the converter's rated output current $I_o(\text{rated})$ in Table 3-1.

Figure 3-1

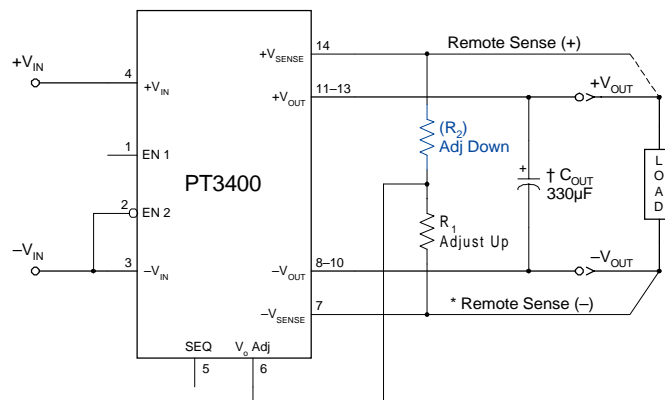

PT3400 Series

Table 3-1

DC/DC CONVERTER ADJUSTMENT RANGE AND FORMULA PARAMETERS

Series Pt #	PT3408	PT3401	PT3402	PT3403	PT3404	PT3405	PT3406	PT3407
I_o (rated) 4	7A	10A	12A	12A	16A	16A	16A	16A
V_o(nom)	5V	3.3V	2.5V	1.8V	1.5V	1.4V	1.2V	1.0V
V_a(min)	4.75V	3.135V	2.375V	N/A 1	N/A 1	N/A 1	N/A 1	N/A 1
V_a(max)	5.25V	3.465V	2.625V	1.98V	1.65V	1.54V	1.32V	1.2V
R_o (kΩ)	8.87	9.76	10.0	6.49	7.5	7.5	7.5	7.5
R_s (kΩ)	66.5	66.5	29.4	66.5	100.0	100.0	100.0	66.5

Table 3-2

DC/DC CONVERTER ADJUSTMENT RESISTOR VALUES

Series Pt #	PT3408	PT3401	PT3402	PT3403	PT3404	PT3405	PT3406	PT3407
V_o(nom)	5V	3.3V	2.5V	1.8V	1.5V	1.4V	1.2V	1.0V
V_a(req'd)								
5.25	4.5kΩ			1.975	7.7kΩ			
5.20	22.2kΩ			1.950	20.0kΩ			
5.15	51.8kΩ			1.925	37.3kΩ			
5.10	111.0kΩ			1.900	63.3kΩ			
5.05	288.0kΩ			1.875	107.0kΩ			
5.00				1.850	193.0kΩ			
4.95	(457.0)kΩ			1.825	453.0kΩ			
4.90	(191.0)kΩ			1.800				
4.85	(102.0)kΩ							
4.80	(57.7)kΩ			1.650	0.0kΩ			
4.75	(31.1)kΩ			1.625	20.0kΩ			
				1.600	50.0kΩ			
3.465		51.8kΩ		1.575	100.0kΩ			
3.432		81.4kΩ		1.550	200.0kΩ			
3.399		131.0kΩ		1.525	500.0kΩ	20.0kΩ		
3.366		229.0kΩ		1.500		50.0kΩ		
3.333		525.0kΩ		1.475		100.0kΩ		
3.330				1.450		200.0kΩ		
3.267		(308.0)kΩ		1.425		500.0kΩ		
3.234		(116.0)kΩ		1.400				
3.201		(51.9)kΩ						
3.168		(19.9)kΩ		1.32			25.0kΩ	
3.135		(0.0)kΩ		1.30			50.0kΩ	
				1.28			87.5kΩ	
2.625			131.0kΩ	1.26			150.0kΩ	
2.600			171.0kΩ	1.24			275.0kΩ	
2.575			237.0kΩ	1.22			650.0kΩ	
2.550			371.0kΩ	1.20				8.5kΩ
2.525			771.0kΩ	1.15				33.5kΩ
2.500				1.10				83.5kΩ
2.475			(161.0)kΩ	1.08				121.0kΩ
2.450			(60.6)kΩ	1.06				184.0kΩ
2.425			(27.3)kΩ	1.04				309.0kΩ
2.400			(10.6)kΩ	1.02				683.0kΩ
2.375			(0.0)kΩ	1.00				

R₁ = Black R₂ = (Blue)

Using the On/Off Enable Controls on the PT3400 Series of DC/DC Converters

The PT3400 series of DC/DC converters incorporate two output enable controls. *EN1* (pin 1) is the ‘positive enable’ input, and *EN2* (pin 2) is the ‘negative enable’ input. Both inputs are electrically referenced to $-V_{in}$ (pin 3), at the input or primary side of the converter. The enable pins are ideally controlled with an open-collector (or open-drain) discrete transistor. A pull-up resistor is not required. If a pull-up resistor is added, the pull-up voltage must be limited to 15V. The logic truth table for EN1 and EN2 is given in Table 2-1, below.

Table 2-1; On/Off Enable Logic

EN1 (pin 1)	EN2 (pin 2)	Output Status
0	×	Off
1	0	On
×	1	Off

Logic ‘0’ = $-V_{in}$ (pin 3) potential
 Logic ‘1’ = Open Circuit

Automatic (UVLO) Power-Up

Connecting *EN2* to $-V_{in}$ and leaving *EN1* open-circuit configures the converter for automatic power up (see data sheet ‘Standard Application’). The converter control circuitry incorporates an ‘under-voltage lockout’ (UVLO), which disables the converter until a minimum input voltage is present at $\pm V_{in}$ (see data sheet specifications). The UVLO ensures a clean transition during power up and power down, allowing the converter to tolerate a slowly rising input voltage. For most applications *EN1* and *EN2*, can be configured for automatic power-up.

Positive Output Enable (Negative Inhibit)

To configure the converter for a positive enable function, connect *EN2* to $-V_{in}$, and apply the system On/Off control signal to *EN1*. In this configuration, applying less than 0.8V (with respect to $-V_{in}$) to *EN1* disables the converter outputs. Figure 2-1 is an example of this implementation.

Figure 2-1; Positive Enable Configuration

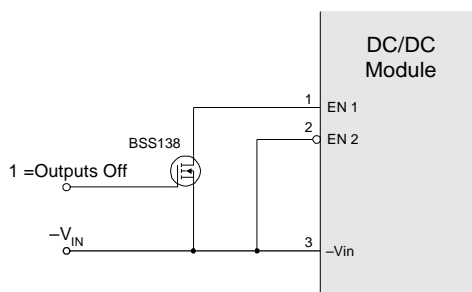

Negative Output Enable (Positive Inhibit)

To configure the converter for a negative enable function, *EN1* is left open circuit, and the system On/Off control signal is applied to *EN2*. Applying less than 0.8V (with respect to $-V_{in}$) to *EN2*, enables the converter outputs. An example of this configuration is provided in Figure 2-2. *Note: The converter will only produce an output voltage if a valid input voltage is applied to $\pm V_{in}$.*

Figure 2-2; Negative Enable Configuration

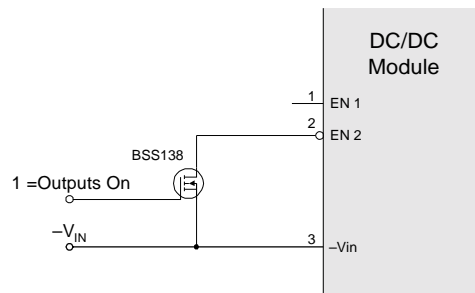

On/Off Enable Turn-On Time

The total turn-on time of the module is the combination of a short delay period, followed by the time it takes the output voltage to rise to full regulation. When the converter is enabled from the *EN1* or *EN2* control inputs, the turn-on delay time (measured from the transition of the enable signal to the instance the outputs begin to rise) is typically 50 milliseconds. By comparison, the rise time of the output voltage is relatively short, and is between 1 and 2 milliseconds. The rise time varies with input voltage, output load current, output capacitance, and the *SEQ* pin function. Figure 2-3 shows the power-up response of a PT3401 (3.3V), following the removal of the ground signal at *EN1* in Figure 2-1.

Figure 2-3; PT3401 Enable Turn-On

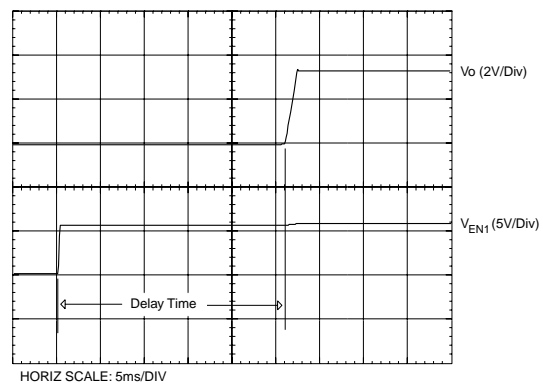

Using the Power-Up Sequencing Feature of the PT3400 Series of DC/DC Converters

Introduction

Power-up sequencing is a term used to describe the order and timing that supply voltages power up in a multi-voltage power supply system. Multi-voltage power supply architectures are a common place requirement in electronic circuits that employ high-performance microprocessors or digital signal processors (DSPs). These circuits require a tightly regulated low-voltage supply for the processor core, and a higher voltage to power the processor's system interface or I/O circuitry. Power-up sequencing is often required between two such voltages in order to manage the voltage differential during the brief period of power-up. This reduces stress and improves the long term reliability of the dual-voltage devices and their associated circuitry. The most popular solution is termed "Simultaneous Startup," whereby the two affected voltages both start at the same time and then rise at the same rate.

Configuration for Power-up Sequencing

The PT3400 series converters have a feature that allows individual modules to be easily configured for simultaneous startup. Using the *SEQ* control (pin 5), two PT3400 modules are simply interconnected with just a few passive components. This eliminates much of the application circuitry that would otherwise be required for this type of setup. The schematic is given in Figure 4-1. The setup is relatively simple but varies slightly with the combination of output voltages being sequenced. Capacitor C_3 (5) is only required when the modules selected are a mix between a high-voltage module (3.3V through 1.8V), and a low-voltage module ($\leq 1.5V$). For all other configurations C_3 is replaced by a wire link. For clarification Table 4-1 indicates which modules are a high voltage type (Type A), and which are a low voltage type (Type B). Table 4-2 provides guidance as to the one combination that requires the capacitor C_3 . Examples of waveforms obtained from a sequenced start-up between two PT3400 series modules are provided in Figure 4-2, Figure 4-3, and Figure 4-4. In each case the voltage difference during the synchronized portion of the power up sequence is typically within 0.4V. Both the timing and tracking of output voltages during the power-up sequence will vary slightly with input voltage, temperature, and with differences in the output capacitance and load current between the two converter modules.

This power-up sequencing solution may not be suitable for every application. To ensure compatibility the application should be tested against all variances. For additional support please contact a Plug-in Power applications specialist.

Table 4-1; PT3400 Module Type Identification

PART No.	VOUT	TYPE A	TYPE B
PT3401	(3.3V)	×	
PT3402	(2.5V)	×	
PT3403	(1.8V)	×	
PT3404	(1.5V)		×
PT3405	(1.4V)		×
PT3406	(1.2V)		×
PT3407	(1.0V)		×

Table 4-2; Value of C_3 in Sequencing Setup

MODULE #1	MODULE #2	C_3	COMMENTS
A	A	Wire link	Waveforms given in Figure 4-2
B	B	Wire link	Waveforms given in Figure 4-3
A	B	0.1 μ F (5)	Waveforms given in Figure 4-4

Notes

1. The two converters configured for sequenced power up must be located close together on the same printed circuit board.
2. When configured for power-up sequencing, a minimum of 1,000 μ F output capacitance is recommended at the output of each converter.
3. The best results are obtained if a load of 1A or greater is present at both converter outputs.
4. The capacitors, C_1 and C_2 , should each be placed close to their associated converter, Module #1, and Module #2 respectively. Combining C_1 and C_2 to a single capacitor of equivalent value is not recommended.
5. The capacitor C_3 is only required whenever a Type A and Type B converter are connected together for sequenced power-up. In this event C_3 should always be connected to the *SEQ* control (pin 5) of the Type B module, or the converter with the lowest output voltage. For all other converter configurations C_3 is not required, and is replaced by a copper trace or wire link.
6. The capacitors selected for C_1 , C_2 , & C_3 should be of good quality and have stable characteristics. Capacitors with an X7R dielectric, and 5% tolerance are recommended.
7. The enable controls, EN1 & EN2, are optional for a sequenced pair of converters. If an enable signal is desired, EN1 or EN2 of both converters units must be controlled from a single transistor.

Figure 4-1; Configuration for Power-Up Sequencing

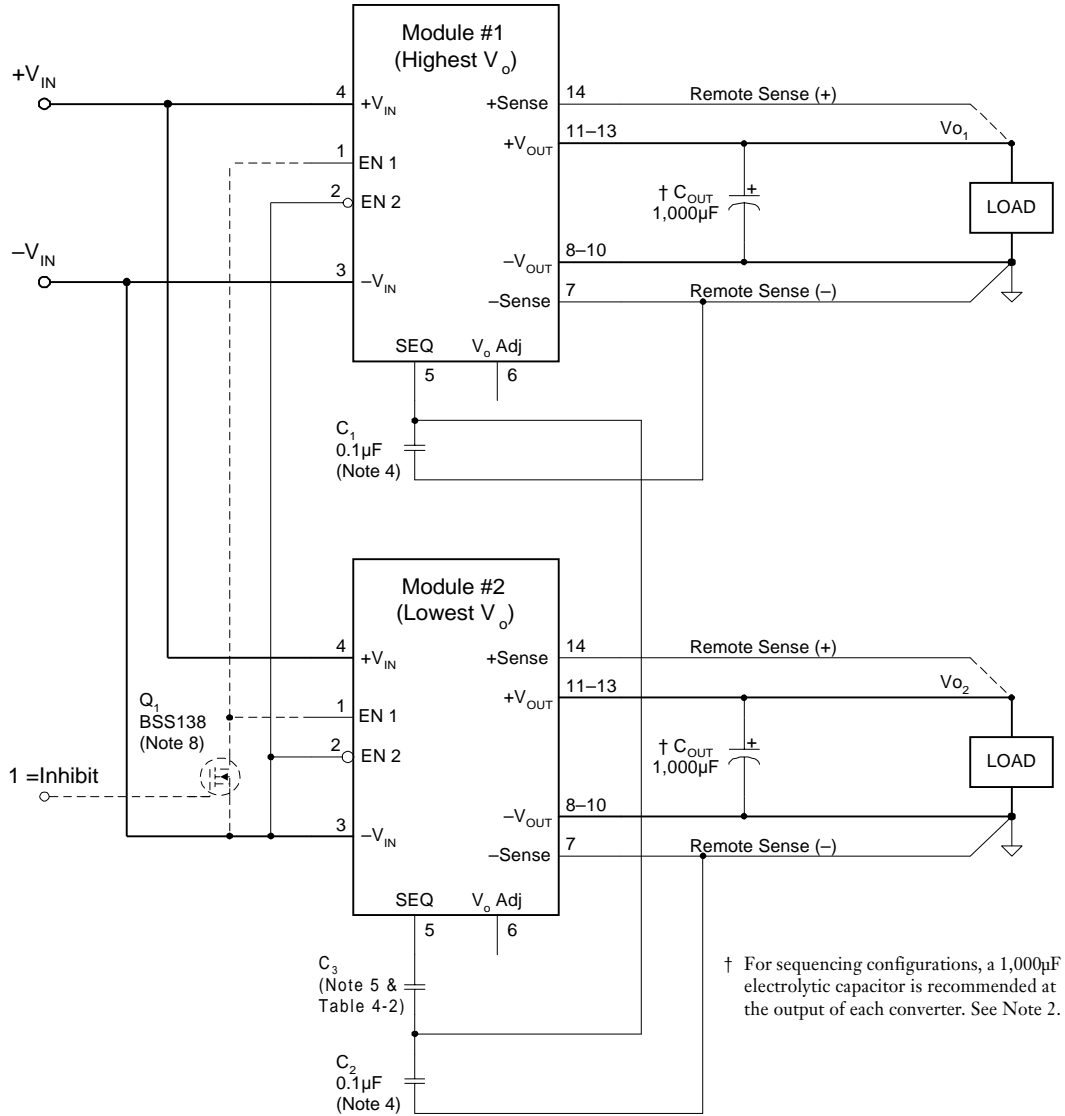
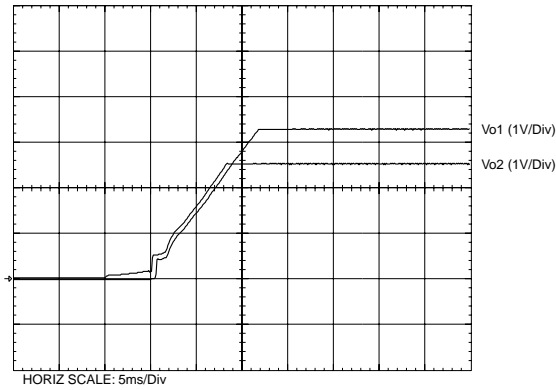
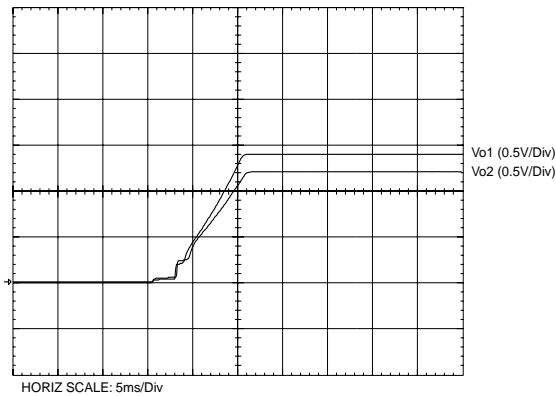

Figure 4-3; Power-Up Sequence Example with Two Type 'A' Modules



The adjacent plot shows an example of power-up sequencing between two Type 'A' modules. In this example the PT3401 (3.3V) and PT3402 (2.5V) are featured. Each converter had a constant current load of 5A applied to its respective output.

Figure 4-2; Power-Up Sequence Example with Two Type 'B' Modules



The adjacent plot shows an example of power-up sequencing between two Type 'B' modules. In this example the PT3405 (1.4V) and PT3406 (1.2V) are featured. Each converter had a constant current load of 5A applied to its respective output.

Figure 4-4; Power-Up Sequence Example Using Type 'A' & 'B' Modules

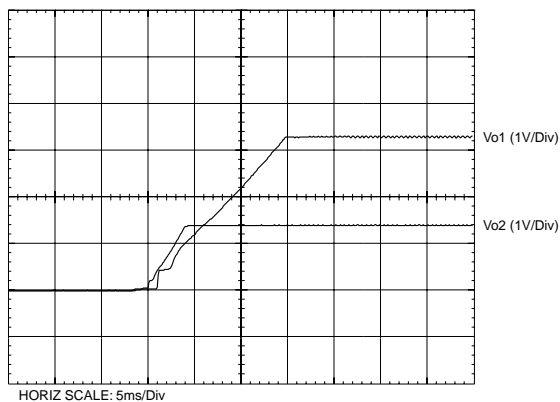

The adjacent plot shows an example of power-up sequencing between a Type 'A' and a Type 'B' module. In this example the PT3401 (3.3V) and PT3405 (1.4V) are featured. Each converter had a constant current load of 5A applied to its respective output.

PACKAGING INFORMATION

Orderable Device	Status ⁽¹⁾	Package Type	Package Drawing	Pins	Package Qty	Eco Plan ⁽²⁾	Lead/ Ball Finish	MSL Peak Temp ⁽³⁾	Samples (Requires Login)
PT3401A	NRND	SIP MODULE	EPM	14	8	TBD	Call TI	Level-1-215C-UNLIM	
PT3401N	OBSOLETE	SIP MODULE	EPL	14		TBD	Call TI	Call TI	
PT3402N	OBSOLETE	SIP MODULE	EPL	14		TBD	Call TI	Call TI	
PT3404A	NRND	SIP MODULE	EPM	14	8	TBD	Call TI	Level-1-215C-UNLIM	
PT3405A	NRND	SIP MODULE	EPM	14	8	TBD	Call TI	Level-1-215C-UNLIM	
PT3405N	OBSOLETE	SIP MODULE	EPL	14		TBD	Call TI	Call TI	
PT3406A	OBSOLETE	SIP MODULE	EPM	14		TBD	Call TI	Call TI	
PT3406N	OBSOLETE	SIP MODULE	EPL	14		TBD	Call TI	Call TI	
PT3408C	NRND	SIP MODULE	EPN	14	8	TBD	Call TI	Level-3-215C-168HRS	
PT3408N	OBSOLETE	SIP MODULE	EPL	14		TBD	Call TI	Call TI	

⁽¹⁾ The marketing status values are defined as follows:

ACTIVE: Product device recommended for new designs.

LIFEBUY: TI has announced that the device will be discontinued, and a lifetime-buy period is in effect.

NRND: Not recommended for new designs. Device is in production to support existing customers, but TI does not recommend using this part in a new design.

PREVIEW: Device has been announced but is not in production. Samples may or may not be available.

OBSOLETE: TI has discontinued the production of the device.

⁽²⁾ Eco Plan - The planned eco-friendly classification: Pb-Free (RoHS), Pb-Free (RoHS Exempt), or Green (RoHS & no Sb/Br) - please check <http://www.ti.com/productcontent> for the latest availability information and additional product content details.

TBD: The Pb-Free/Green conversion plan has not been defined.

Pb-Free (RoHS): TI's terms "Lead-Free" or "Pb-Free" mean semiconductor products that are compatible with the current RoHS requirements for all 6 substances, including the requirement that lead not exceed 0.1% by weight in homogeneous materials. Where designed to be soldered at high temperatures, TI Pb-Free products are suitable for use in specified lead-free processes.

Pb-Free (RoHS Exempt): This component has a RoHS exemption for either 1) lead-based flip-chip solder bumps used between the die and package, or 2) lead-based die adhesive used between the die and leadframe. The component is otherwise considered Pb-Free (RoHS compatible) as defined above.

Green (RoHS & no Sb/Br): TI defines "Green" to mean Pb-Free (RoHS compatible), and free of Bromine (Br) and Antimony (Sb) based flame retardants (Br or Sb do not exceed 0.1% by weight in homogeneous material)

⁽³⁾ MSL, Peak Temp. -- The Moisture Sensitivity Level rating according to the JEDEC industry standard classifications, and peak solder temperature.

Important Information and Disclaimer: The information provided on this page represents TI's knowledge and belief as of the date that it is provided. TI bases its knowledge and belief on information provided by third parties, and makes no representation or warranty as to the accuracy of such information. Efforts are underway to better integrate information from third parties. TI has taken and continues to take reasonable steps to provide representative and accurate information but may not have conducted destructive testing or chemical analysis on incoming materials and chemicals. TI and TI suppliers consider certain information to be proprietary, and thus CAS numbers and other limited information may not be available for release.

In no event shall TI's liability arising out of such information exceed the total purchase price of the TI part(s) at issue in this document sold by TI to Customer on an annual basis.

IMPORTANT NOTICE

Texas Instruments Incorporated and its subsidiaries (TI) reserve the right to make corrections, modifications, enhancements, improvements, and other changes to its products and services at any time and to discontinue any product or service without notice. Customers should obtain the latest relevant information before placing orders and should verify that such information is current and complete. All products are sold subject to TI's terms and conditions of sale supplied at the time of order acknowledgment.

TI warrants performance of its hardware products to the specifications applicable at the time of sale in accordance with TI's standard warranty. Testing and other quality control techniques are used to the extent TI deems necessary to support this warranty. Except where mandated by government requirements, testing of all parameters of each product is not necessarily performed.

TI assumes no liability for applications assistance or customer product design. Customers are responsible for their products and applications using TI components. To minimize the risks associated with customer products and applications, customers should provide adequate design and operating safeguards.

TI does not warrant or represent that any license, either express or implied, is granted under any TI patent right, copyright, mask work right, or other TI intellectual property right relating to any combination, machine, or process in which TI products or services are used. Information published by TI regarding third-party products or services does not constitute a license from TI to use such products or services or a warranty or endorsement thereof. Use of such information may require a license from a third party under the patents or other intellectual property of the third party, or a license from TI under the patents or other intellectual property of TI.

Reproduction of TI information in TI data books or data sheets is permissible only if reproduction is without alteration and is accompanied by all associated warranties, conditions, limitations, and notices. Reproduction of this information with alteration is an unfair and deceptive business practice. TI is not responsible or liable for such altered documentation. Information of third parties may be subject to additional restrictions.

Resale of TI products or services with statements different from or beyond the parameters stated by TI for that product or service voids all express and any implied warranties for the associated TI product or service and is an unfair and deceptive business practice. TI is not responsible or liable for any such statements.

TI products are not authorized for use in safety-critical applications (such as life support) where a failure of the TI product would reasonably be expected to cause severe personal injury or death, unless officers of the parties have executed an agreement specifically governing such use. Buyers represent that they have all necessary expertise in the safety and regulatory ramifications of their applications, and acknowledge and agree that they are solely responsible for all legal, regulatory and safety-related requirements concerning their products and any use of TI products in such safety-critical applications, notwithstanding any applications-related information or support that may be provided by TI. Further, Buyers must fully indemnify TI and its representatives against any damages arising out of the use of TI products in such safety-critical applications.

TI products are neither designed nor intended for use in military/aerospace applications or environments unless the TI products are specifically designated by TI as military-grade or "enhanced plastic." Only products designated by TI as military-grade meet military specifications. Buyers acknowledge and agree that any such use of TI products which TI has not designated as military-grade is solely at the Buyer's risk, and that they are solely responsible for compliance with all legal and regulatory requirements in connection with such use.

TI products are neither designed nor intended for use in automotive applications or environments unless the specific TI products are designated by TI as compliant with ISO/TS 16949 requirements. Buyers acknowledge and agree that, if they use any non-designated products in automotive applications, TI will not be responsible for any failure to meet such requirements.

Following are URLs where you can obtain information on other Texas Instruments products and application solutions:

Products

Audio	www.ti.com/audio
Amplifiers	amplifier.ti.com
Data Converters	dataconverter.ti.com
DLP® Products	www.dlp.com
DSP	dsp.ti.com
Clocks and Timers	www.ti.com/clocks
Interface	interface.ti.com
Logic	logic.ti.com
Power Mgmt	power.ti.com
Microcontrollers	microcontroller.ti.com
RFID	www.ti-rfid.com
RF/IF and ZigBee® Solutions	www.ti.com/lprf

Applications

Communications and Telecom	www.ti.com/communications
Computers and Peripherals	www.ti.com/computers
Consumer Electronics	www.ti.com/consumer-apps
Energy and Lighting	www.ti.com/energy
Industrial	www.ti.com/industrial
Medical	www.ti.com/medical
Security	www.ti.com/security
Space, Avionics and Defense	www.ti.com/space-avionics-defense
Transportation and Automotive	www.ti.com/automotive
Video and Imaging	www.ti.com/video
Wireless	www.ti.com/wireless-apps

TI E2E Community Home Page

e2e.ti.com

Mailing Address: Texas Instruments, Post Office Box 655303, Dallas, Texas 75265
Copyright © 2011, Texas Instruments Incorporated