

Features

- Single Device: +5V Input
- Complimentary Dual Output: $\pm 12V$, $\pm 15V$
- Wide Input Voltage Range
- 85% Efficiency
- Adjustable Output Voltage
- Laser-trimmed

Description

The PT5060 series of dual-output Integrated Switching Regulators (ISRs) provide a complimentary $\pm 12V$ or $\pm 15V$ from a single +5V input. Applications include systems that require power for analog interface circuitry, such as D/A and A/D converters, and Op Amps. The output voltage can be adjusted with an external resistor. These ISRs are made available in a 12-pin single in-line pin (SIP) package. Note that these modules are not short-circuit protected.

Standard Application

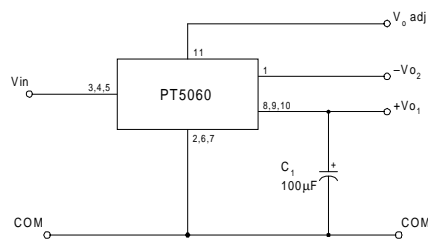

C_1 = Required 100µF electrolytic

Pin-Out Information

Pin	Function
1	$-V_{O2}$
2	GND
3	V_{in}
4	V_{in}
5	V_{in}
6	GND
7	GND
8	$+V_{O1}$
9	$+V_{O1}$
10	$+V_{O1}$
11	V_o Adj
12	Do Not Connect

Ordering Information

PT5061□ = ± 12 Volts

PT5062□ = ± 15 Volts

PT Series Suffix (PT1234 x)

Case/Pin Configuration	Order Suffix	Package Code *
Vertical	N	(ECD)
Horizontal	A	(ECA)
SMD	C	(ECC)
Vertical, Side Tabs	R	(ECE)
Horizontal, Side Tabs	G	(ECG)
SMD, Side Tabs	B	(ECK)

* Previously known as package style 300.

(Reference the applicable package code drawing for the dimensions and PC board layout)

Specifications (Unless otherwise stated, $T_a = 25^\circ C$, $V_{in} = +5V$, $I_o = I_{o,max}$, $C_1 = 100\mu F$)

Characteristics	Symbol	Conditions	PT5060 SERIES			Units	
			Min	Typ	Max		
Output Current	I_o	Over V_{in} range	$V_{O1} = +12V$ $V_{O2} = -12V$	0.05 0.05 (1)	— —	0.50 0.25	A
Current Limit	I_{lim}			—	150 (2)	—	$\%I_{o,max}$
Inrush Current	I_{ir}	On start up		—	5.5 (3)	—	A
	t_{tr}			—	2	—	mSec
Input Voltage Range	V_{in}	Over I_o range		4.75	—	$+V_o - 1$	V
Output Voltage Tolerance	ΔV_o	Over V_{in} and I_o ranges $T_a = 0^\circ C$ to SOA limit (3)	$+V_{O1}$ $-V_{O2}$	— —	± 1.5 ± 5	± 3.0 ± 10	$\%V_o$
Line Regulation	Reg_{line}	Over V_{in} range		—	± 0.5	± 1.0	$\%V_o$
Load Regulation	Reg_{load}	$0.1 \leq I_o \leq I_{o,max}$		—	± 0.5	± 1.0	$\%V_o$
V_o Ripple (pk-pk)	V_n	20MHz bandwidth	$+V_{O1}$ $-V_{O2}$	— —	± 1.5 ± 2	± 3 ± 3	$\%V_o$
Transient Response	t_{tr} V_{os}	25% load change V_o over/undershoot		— —	100 3	— 5	μSec $\%V_o$
Efficiency	η	$I_o = 0.2A$ each output		—	85	—	%
Switching Frequency	f_s	Over V_{in} and I_o ranges		—	650	—	kHz
Operating Temperature Range	T_a	—		0	—	$+85$ (4)	$^\circ C$
Storage Temperature	T_s	—		-40	—	$+125$	$^\circ C$
Mechanical Shock		Per Mil-STD-883D, Method 2002.3, 1 msec, Half Sine, mounted to a fixture	—	500	—	G's	
Mechanical Vibration		Per Mil-STD-883D, Method 2007.2 20-2000 Hz, Soldered in a PC board	—	15	—	G's	
Weight				—	6.5	—	grams

- Notes:**
- (1) Do not operate the negative output rail of these ISRs below the minimum load.
 - (2) ISRs based on a boost topology are not short-circuit protected.
 - (3) The inrush current stated is above the normal input current for the associated output load.
 - (4) See Safe Operating Area curves or consult the factory for the appropriate derating.

PT5061 +/- 12VDC (See Note A)

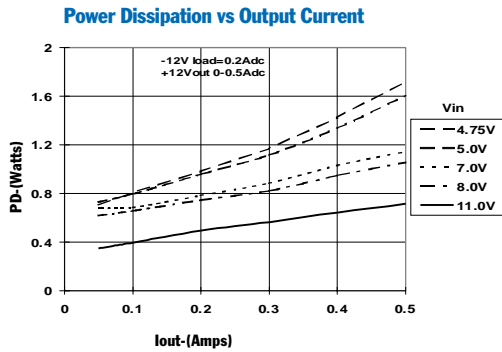
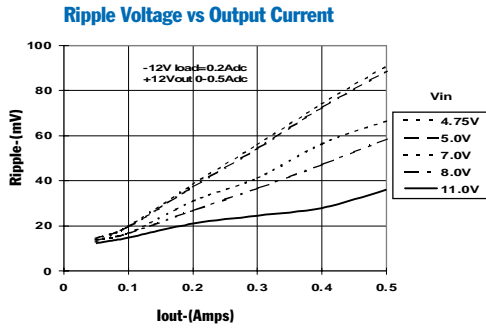
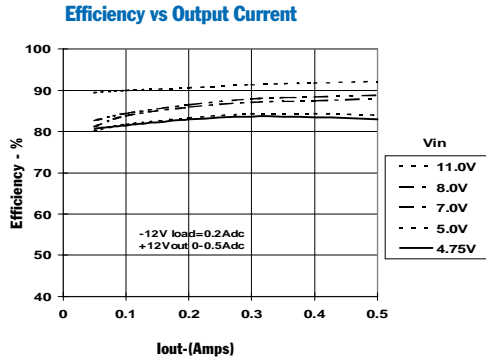

Safe Operating Area, $V_{in} = 5.0V$; $I_{o2} = 0.25A$ (See Note B)

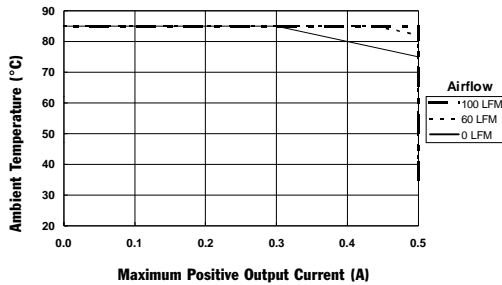

PT5062 +/- 15V (See Note A)

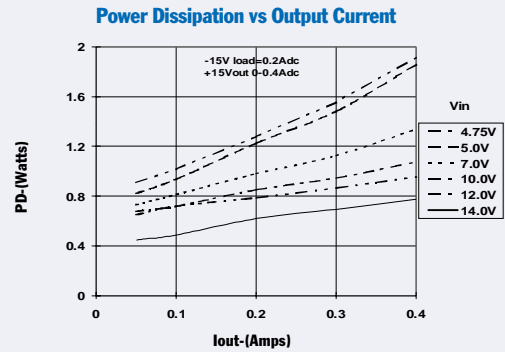
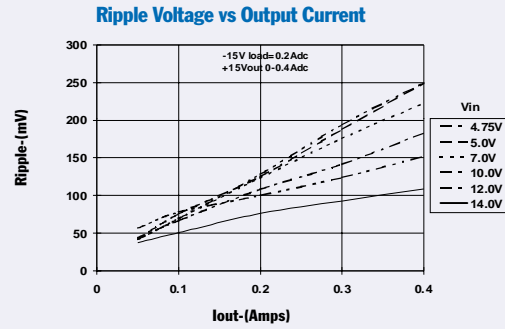
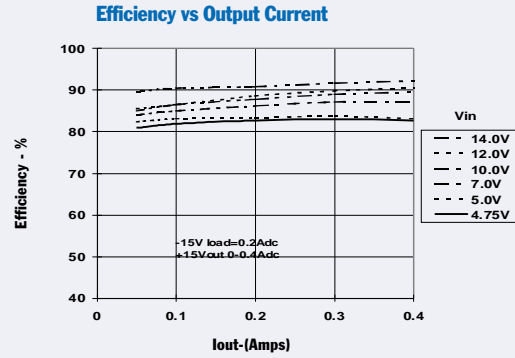

Safe Operating Area $V_{in} = 5.0V$, $I_{o2} = 0.2A$ (See Note B)

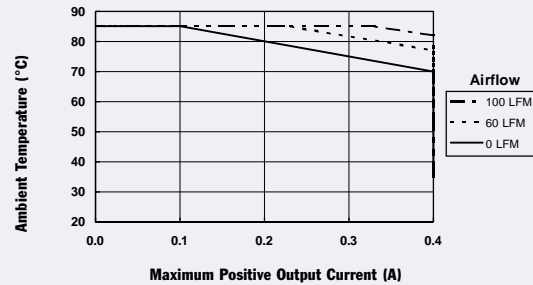

Note A: Characteristic data has been developed from actual products tested at 25°C. This data is considered typical data for the Converter.
Note B: Thermal derating graphs are developed in free-air convection cooling, which corresponds to approximately 40-60 LFM of airflow.

Adjusting the Output Voltage of the PT5060 Dual-Output Boost Converter Series

The dual output voltage of the PT5060 series modules can be adjusted higher or lower than the factory pre-set voltage with the addition of a single external resistor. Table 1 gives the applicable adjustment range for each model in the series as V_a (min) and V_a (max).

Adjust Up: An increase in the output voltage is obtained by adding a resistor R_2 , between pin 11 (V_o adj) and pins 2, 6, or 7 (GND).

Adjust Down: Add a resistor (R_1), between pin 11 (V_o adj) and pins 8, 9 or 10 (V_{o1}).

Refer to Figure 1 and Table 2 for both the placement and value of the required resistor, either (R_1) or R_2 as appropriate.

Notes:

- Both the positive and negative voltage outputs from the ISR are adjusted simultaneously.
- Use only a single 1% resistor in either the (R_1) or R_2 location. Place the resistor as close to the ISR as possible.
- Never connect capacitors from V_o adj to either GND or V_{o1} . Any capacitance added to the V_o adjust pin will affect the stability of the ISR.
- An increase in the output voltage must be accompanied by a corresponding reduction in the specified maximum current at each output. For V_{o1} and $-V_{o2}$, the revised maximum output current must be reduced to the equivalent of 6 watts and 3 watts respectively. i.e.

$$I_{o1}(\text{max}) = \frac{6}{V_a} \text{ A dc}$$

$$\text{and } I_{o2}(\text{max}) = \frac{3}{V_a} \text{ A dc,}$$

where V_a is the adjusted output voltage.

- Adjustments to the output voltage will also limit the maximum input voltage that can be applied to the ISR. The maximum input voltage that may be applied is limited to $(V_o - 1)\text{Vdc}$ or 14Vdc, whichever is less.

Figure 1

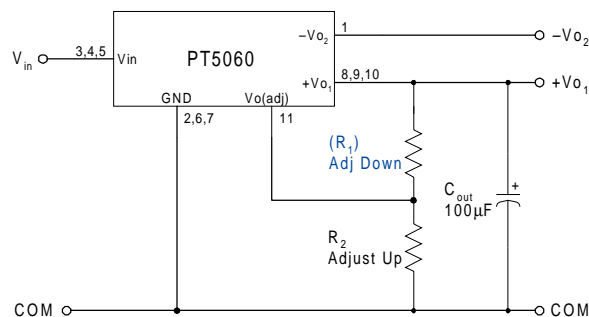

The values of (R_1) [adjust down], and R_2 [adjust up], can also be calculated using the following formulas.

$$(R_1) = \frac{3.65 (V_a - 2.5)}{(V_o - V_a)} - 0.1 \quad \text{k}\Omega$$

$$R_2 = \frac{9.125}{V_a - V_o} - 0.1 \quad \text{k}\Omega$$

Where: V_o = Original output voltage
 V_a = Adjusted output voltage

Table 1

PT5060 ADJUSTMENT AND FORMULA PARAMETERS		
Series Pt #	PT5061	PT5062
V_o (nom)	$\pm 12.0\text{V}$	$\pm 15.0\text{V}$
V_a (min)	$\pm 7.5\text{V}$	$\pm 7.5\text{V}$
V_a (max)	$\pm 14.0\text{V}$	$\pm 20.0\text{V}$

Table 2

PT5060 ADJUSTMENT RESISTOR VALUES		
Series Pt #	PT5061	PT5062
Current	0.5/0.25A dc	0.4/0.2A dc
V_o (nom)	$\pm 12.0\text{Vdc}$	$\pm 15.0\text{Vdc}$
V_a (req'd)		
7.0		
7.5	(4.0)k Ω	(2.3)k Ω
8.0	(4.9)k Ω	(2.8)k Ω
8.5	(6.2)k Ω	(3.3)k Ω
9.0	(7.8)k Ω	(3.9)k Ω
9.5	(10.1)k Ω	(4.6)k Ω
10.0	(13.6)k Ω	(5.4)k Ω
10.5	(19.4)k Ω	(6.4)k Ω
11.0	(30.9)k Ω	(7.7)k Ω
11.5	(65.6)k Ω	(9.3)k Ω
12.0		(11.5)k Ω
12.5	18.2k Ω	(14.5)k Ω
13.0	9.0k Ω	(19.1)k Ω
13.5	6.0k Ω	(26.7)k Ω
14.0	4.5k Ω	(41.9)k Ω
14.5		(87.5)k Ω
15.0		
15.5		18.2k Ω
16.0		9.0k Ω
16.5		6.0k Ω
17.0		4.5k Ω
17.5		3.6k Ω
18.0		2.9k Ω
18.5		2.5k Ω
19.0		2.2k Ω
19.5		1.9k Ω
20.0		1.7k Ω

R_1 = (Blue) R_2 = Black

PACKAGING INFORMATION

Orderable Device	Status ⁽¹⁾	Package Type	Package Drawing	Pins	Package Qty	Eco Plan ⁽²⁾	Lead/Ball Finish	MSL Peak Temp ⁽³⁾
PT5061A	ACTIVE	SIP MOD ULE	ECA	12	12	TBD	Call TI	Level-1-215C-UNLIM
PT5061C	ACTIVE	SIP MOD ULE	ECC	12	12	TBD	Call TI	Level-1-215C-UNLIM
PT5061G	ACTIVE	SIP MOD ULE	ECG	12	12	TBD	Call TI	Level-1-215C-UNLIM
PT5061N	ACTIVE	SIP MOD ULE	ECD	12	12	TBD	Call TI	Level-1-215C-UNLIM
PT5061R	ACTIVE	SIP MOD ULE	ECE	12	12	TBD	Call TI	Level-1-215C-UNLIM
PT5062A	ACTIVE	SIP MOD ULE	ECA	12	12	TBD	Call TI	Level-1-215C-UNLIM
PT5062C	ACTIVE	SIP MOD ULE	ECC	12	12	TBD	Call TI	Level-1-215C-UNLIM
PT5062CT	ACTIVE	SIP MOD ULE	ECC	12	200	TBD	Call TI	Level-1-215C-UNLIM
PT5062G	ACTIVE	SIP MOD ULE	ECG	12	12	TBD	Call TI	Level-1-215C-UNLIM
PT5062N	ACTIVE	SIP MOD ULE	ECD	12	12	TBD	Call TI	Level-1-215C-UNLIM
PT5062R	ACTIVE	SIP MOD ULE	ECE	12	12	TBD	Call TI	Level-1-215C-UNLIM

⁽¹⁾ The marketing status values are defined as follows:

ACTIVE: Product device recommended for new designs.

LIFEBUY: TI has announced that the device will be discontinued, and a lifetime-buy period is in effect.

NRND: Not recommended for new designs. Device is in production to support existing customers, but TI does not recommend using this part in a new design.

PREVIEW: Device has been announced but is not in production. Samples may or may not be available.

OBSOLETE: TI has discontinued the production of the device.

⁽²⁾ Eco Plan - The planned eco-friendly classification: Pb-Free (RoHS), Pb-Free (RoHS Exempt), or Green (RoHS & no Sb/Br) - please check <http://www.ti.com/productcontent> for the latest availability information and additional product content details.

TBD: The Pb-Free/Green conversion plan has not been defined.

Pb-Free (RoHS): TI's terms "Lead-Free" or "Pb-Free" mean semiconductor products that are compatible with the current RoHS requirements for all 6 substances, including the requirement that lead not exceed 0.1% by weight in homogeneous materials. Where designed to be soldered at high temperatures, TI Pb-Free products are suitable for use in specified lead-free processes.

Pb-Free (RoHS Exempt): This component has a RoHS exemption for either 1) lead-based flip-chip solder bumps used between the die and package, or 2) lead-based die adhesive used between the die and leadframe. The component is otherwise considered Pb-Free (RoHS compatible) as defined above.

Green (RoHS & no Sb/Br): TI defines "Green" to mean Pb-Free (RoHS compatible), and free of Bromine (Br) and Antimony (Sb) based flame retardants (Br or Sb do not exceed 0.1% by weight in homogeneous material)

⁽³⁾ MSL, Peak Temp. -- The Moisture Sensitivity Level rating according to the JEDEC industry standard classifications, and peak solder temperature.

Important Information and Disclaimer:The information provided on this page represents TI's knowledge and belief as of the date that it is provided. TI bases its knowledge and belief on information provided by third parties, and makes no representation or warranty as to the accuracy of such information. Efforts are underway to better integrate information from third parties. TI has taken and continues to take reasonable steps to provide representative and accurate information but may not have conducted destructive testing or chemical analysis on incoming materials and chemicals. TI and TI suppliers consider certain information to be proprietary, and thus CAS numbers and other limited information may not be available for release.

In no event shall TI's liability arising out of such information exceed the total purchase price of the TI part(s) at issue in this document sold by TI

to Customer on an annual basis.

IMPORTANT NOTICE

Texas Instruments Incorporated and its subsidiaries (TI) reserve the right to make corrections, modifications, enhancements, improvements, and other changes to its products and services at any time and to discontinue any product or service without notice. Customers should obtain the latest relevant information before placing orders and should verify that such information is current and complete. All products are sold subject to TI's terms and conditions of sale supplied at the time of order acknowledgment.

TI warrants performance of its hardware products to the specifications applicable at the time of sale in accordance with TI's standard warranty. Testing and other quality control techniques are used to the extent TI deems necessary to support this warranty. Except where mandated by government requirements, testing of all parameters of each product is not necessarily performed.

TI assumes no liability for applications assistance or customer product design. Customers are responsible for their products and applications using TI components. To minimize the risks associated with customer products and applications, customers should provide adequate design and operating safeguards.

TI does not warrant or represent that any license, either express or implied, is granted under any TI patent right, copyright, mask work right, or other TI intellectual property right relating to any combination, machine, or process in which TI products or services are used. Information published by TI regarding third-party products or services does not constitute a license from TI to use such products or services or a warranty or endorsement thereof. Use of such information may require a license from a third party under the patents or other intellectual property of the third party, or a license from TI under the patents or other intellectual property of TI.

Reproduction of information in TI data books or data sheets is permissible only if reproduction is without alteration and is accompanied by all associated warranties, conditions, limitations, and notices. Reproduction of this information with alteration is an unfair and deceptive business practice. TI is not responsible or liable for such altered documentation.

Resale of TI products or services with statements different from or beyond the parameters stated by TI for that product or service voids all express and any implied warranties for the associated TI product or service and is an unfair and deceptive business practice. TI is not responsible or liable for any such statements.

Following are URLs where you can obtain information on other Texas Instruments products and application solutions:

Products		Applications	
Amplifiers	amplifier.ti.com	Audio	www.ti.com/audio
Data Converters	dataconverter.ti.com	Automotive	www.ti.com/automotive
DSP	dsp.ti.com	Broadband	www.ti.com/broadband
Interface	interface.ti.com	Digital Control	www.ti.com/digitalcontrol
Logic	logic.ti.com	Military	www.ti.com/military
Power Mgmt	power.ti.com	Optical Networking	www.ti.com/opticalnetwork
Microcontrollers	microcontroller.ti.com	Security	www.ti.com/security
Low Power Wireless	www.ti.com/lpw	Telephony	www.ti.com/telephony
		Video & Imaging	www.ti.com/video
		Wireless	www.ti.com/wireless

Mailing Address: Texas Instruments
Post Office Box 655303 Dallas, Texas 75265