



Features

- 40ADC Output Current
- +3.3V or +5V Input
- Low Output Voltages: 0.8V—2.7V
- High Efficiency
- Programmable Output: (VRM Compatible 5-bit Codes)
- Multiphase Topology
- Output Remote Sense
- Short-Circuit Protection
- Thermal Shutdown
- Standby On/Off Control
- Space-Saving Package
- Solderable Copper Case

Description

The PT8100 Excalibur™ power modules are a family of high-output, high-efficiency, fully integrated switching regulators (ISRs), housed in a solderable 31-pin space-saving copper package. Modules are available for operation from either a 3.3V or 5V nominal input bus voltage. Each provides up to 40A of output current at output voltages as low as 0.8V. The output voltage is programmable via a 5-bit input code.

The PT8100 series incorporates a state-of-the-art, 2-phase, multiple power path topology. This extends the output current range while providing superior transient response

and input current ripple performance. The modules are designed for high-end computing and signal processing applications, both of which demand high output currents at low supply voltages.

The modules have a number of standard features to facilitate system integration. These include short-circuit protection, thermal shutdown, standby (On/Off) control, and an output remote sense to compensate for voltage drop between the regulator and the load. In addition, the voltage programming codes are compatible with Intel's® VRM specifications.

Ordering Information

Part No.	Output Voltage Program Range	Input Bus
PT8101□	=1.300 to 2.70V	5V
PT8102□	=1.075 to 1.85V	5V
PT8103□	=1.075 to 1.85V	3.3V
PT8104□	=1.050 to 1.825V	5V
PT8105□	=0.800 to 1.575V	3.3V

PT Series Suffix (PT1234 x)

Case/Pin Configuration	Order Suffix	Package Code
Vertical	N	(EKH)
Horizontal	A	(EKF)
SMD	C	(EKG)

(Reference the applicable package code drawing for the dimensions and PC board layout)

Standard Application (See p.3 for PT8104 application schematic)

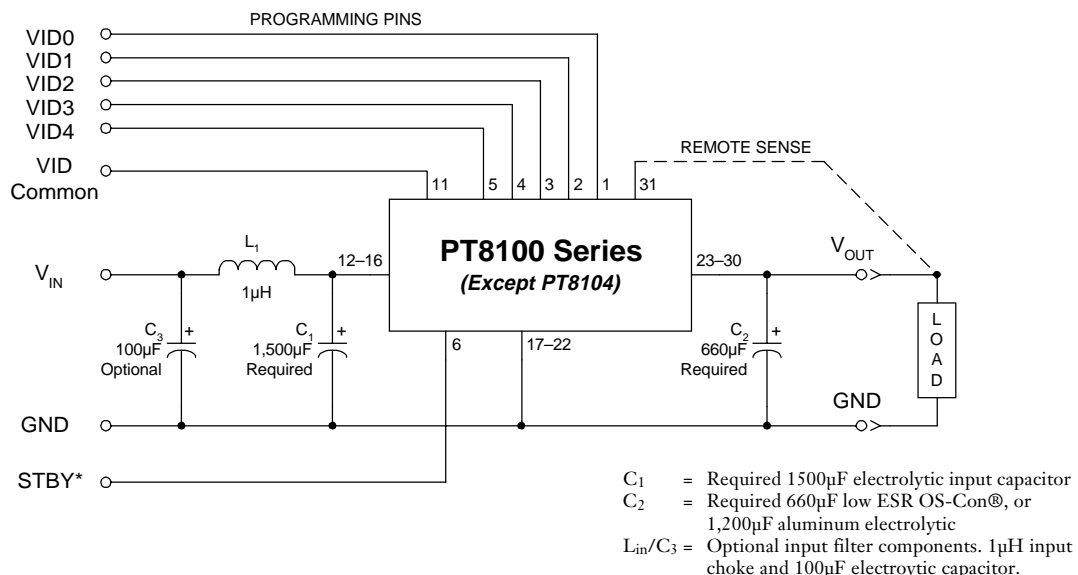

Pin-Out Information (Except PT8104 –see p.3)

Pin	Function	Pin	Function	Pin	Function
1	VID 0	12	V _{in}	22	GND
2	VID 1	13	V _{in}	23	V _{out}
3	VID 2	14	V _{in}	24	V _{out}
4	VID 3	15	V _{in}	25	V _{out}
5	VID 4	16	V _{in}	26	V _{out}
6	STBY*	17	GND	27	V _{out}
7	Do Not Connect	18	GND	28	V _{out}
8	Do Not Connect	19	GND	29	V _{out}
9	Do Not Connect	20	GND	30	V _{out}
10	Do Not Connect	21	GND	31	Remote Sense
11	VID Common				

* For STBY pin:
 Open = Output Enabled
 VID Common = Output Disabled

Voltage Programming Information (Except PT8104 –see p.3)

VID 3	VID 2	VID 1	VID 0	PT8101 (VRM 8.4)		PT8102/8103 (VRM 9.1)		PT8105 (Custom Code)	
				VID 4=1 Vout ^(iv)	VID 4=0 Vout	VID 4=1 Vout	VID 4=0 Vout	VID 4=1 Vout	VID 4=0 Vout
1	1	1	1	2.00	1.30V	1.075V	1.475V	0.800V	1.200V
1	1	1	0	2.10	1.35V	1.100V	1.500V	0.825V	1.225V
1	1	0	1	2.30	1.40V	1.125V	1.525V	0.850V	1.250V
1	1	0	0	2.40	1.45V	1.150V	1.550V	0.875V	1.275V
1	0	1	1	2.50	1.50V	1.175V	1.575V	0.900V	1.300V
1	0	1	0	2.60	1.55V	1.200V	1.600V	0.925V	1.325V
1	0	0	1	2.70	1.60V	1.225V	1.625V	0.950V	1.350V
1	0	0	0	N/A	1.65V	1.250V	1.650V	0.975V	1.375V
0	1	1	1	N/A	1.70V	1.275V	1.675V	1.000V	1.400V
0	1	1	0	N/A	1.75V	1.300V	1.700V	1.025V	1.425V
0	1	0	1	N/A	1.80V	1.325V	1.725V	1.050V	1.450V
0	1	0	0	N/A	1.85V	1.350V	1.750V	1.075V	1.475V
0	0	1	1	N/A	1.90V	1.375V	1.775V	1.100V	1.500V
0	0	1	0	N/A	1.95V	1.400V	1.800V	1.125V	1.525V
0	0	0	1	N/A	2.00V	1.425V	1.825V	1.150V	1.550V
0	0	0	0	N/A	2.05V	1.450V	1.850V	1.175V	1.575V

Notes:

- i) Logic 0 = Connect to VID Common
- ii) Logic 1 = Open circuit (no pull-up resistors)
- iii) VID3 and VID4 may not be changed while the unit is operating.
- iv) The output voltage of the PT8101 must not be set higher than 2.7V.

PT8101 /2 Specifications (Unless otherwise stated $T_a = 25^\circ\text{C}$, $C_1 = 1,500\mu\text{F}$, $C_2 = 660\mu\text{F}$, $V_{in} = 5\text{V}$, & $I_o = 40\text{A}$)

Characteristics	Symbols	Conditions	PT8101/2, $V_{in} = 5\text{V}$			Units	
			Min	Typ	Max		
Output Current	I_o	25°C, natural convection 60°C with 200LFM airflow	0.1 (1) 0.1 (1)	—	38 40	A	
Input Voltage Range	V_{in}	Over I_o Range	4.5	—	5.5	V	
Set-Point Voltage Tolerance	$V_o \text{ tol}$	Over V_o range	—	± 1	± 2	%V	
Line Regulation	ΔReg_{line}	Over V_{in} range	—	± 5	—	mV	
Load Regulation	ΔReg_{load}	Over I_o range	—	± 5	—	mV	
Temperature Variation	ΔReg_{temp}	$-40^\circ\text{C} \leq T_a \leq 85^\circ\text{C}$	—	± 0.5	—	% V_o	
Total Output Voltage Variation	$\Delta V_{o \text{ tot}}$	Includes set-point, line load, $-40^\circ\text{C} \leq T_a \leq 85^\circ\text{C}$	—	—	± 3	%V	
Efficiency	η	$I_o = 20\text{A}$	$V_o = 2.5\text{V}$	—	93	—	%
			$V_o = 1.8\text{V}$	—	90	—	
			$V_o = 1.5\text{V}$	—	88	—	
			$V_o = 1.2\text{V}$	—	86	—	
		$I_o = 40\text{A}$	$V_o = 2.5\text{V}$	—	89	—	%
			$V_o = 1.8\text{V}$	—	85	—	
			$V_o = 1.5\text{V}$	—	83	—	
			$V_o = 1.2\text{V}$	—	81	—	
V_o Ripple (pk-pk)	V_r	20MHz bandwidth	—	25	—	mV	
Transient Response ($V_o = 1.8\text{V}$)	t_{tr}	1A/ μs load step, 50% to 100% $I_{o \text{ max}}$	—	50	—	μSec	
	ΔV_{tr}	V_o over/undershoot	—	75	—	mV	
Transient Response ($V_o = 1.2\text{V}$)	t_{tr}	1A/ μs load step, 50% to 100% $I_{o \text{ max}}$	—	25	—	μSec	
	ΔV_{tr}	V_o over/undershoot	—	30	—	mV	
Short Circuit Threshold	$I_{o \text{ sc}}$	—	—	60	—	A	
Switching Frequency	f_o	Over load range	300	350	400	kHz	
Standby Control (pin 6) Input High Voltage Input Low Voltage Input Low Current	V_{IH}	Referenced to GND (pins 17–22)	—	—	Open (2)	V	
	V_{IL}		-0.2	—	0.8		
	I_{IL}	Pin 6 to GND	—	0.5	—	mA	
Standby Input Current	$I_{in \text{ standby}}$	Pin 6 to GND	—	35	—	mA	
External Output Capacitance	C_2	See application schematic	660 (5)	—	15,000	μF	
External Input Capacitance	C_1	See application schematic	1,500	—	—	μF	
Operating Temperature Range	T_a	Over V_{in} Range	-40 (3)	—	+85 (4)	$^\circ\text{C}$	
Storage Temperature	T_s	—	-40	—	+125	$^\circ\text{C}$	
Mechanical Shock	—	Per Mil-STD-883D, Method 2002.3 1 msec, Half Sine, mounted to a fixture	—	500	—	G's	
Mechanical Vibration	—	Mil-STD-883D, Method 2007.2 20-2000 Hz, soldered in PCB	Vertical	—	20 (6)	—	G's
			Horizontal	—	20 (6)	—	
Weight	—	Vertical/Horizontal	—	55	—	grams	
Flammability	—	Materials meet UL 94V-0	—	—	—	—	

Notes: (1) ISR will operate down to no load with reduced specifications.

(2) The Standby input (pin 6) has an internal pull-up. If it is left open-circuit the module will operate when input power is applied. A low-leakage MOSFET is recommended to control this input. The open-circuit voltage is nominally 5V. See application notes for interface considerations.

(3) For operation below 0°C, C_{out} must have stable characteristics. Use either low ESR tantalum or Oscon® capacitors.

(4) See safe Operating Area curves or consult factory for the appropriate derating.

(5) The PT8100 regulators require a minimum of 660 μF , low ESR output capacitance (1,200 μF for standard aluminum electrolytic) for proper operation.

(6) The case pins on the through-hole package types (suffixes N & A) must be soldered. For more information see the applicable package outline drawing.

Input Filter: The filter components L_1 , and C_3 are optional for most applications. The inductor must be rated to handle the projected input current. A rating of 30ADC is recommended. The capacitance C_1 must be rated for a minimum of 1Arms of ripple current. For transient or dynamic load applications, additional capacitance may be required. For more information refer to the application note on capacitor recommendations for this product.

PT8100 Series

40-A 3.3/5-V Input Programmable Integrated Switching Regulator

PT8103/5 Specifications (Unless otherwise stated $T_a = 25^\circ\text{C}$, $C_1 = 1,500\mu\text{F}$, $C_2 = 660\mu\text{F}$, $V_{in} = 3.3\text{V}$, & $I_o = 40\text{A}$)

Characteristics	Symbols	Conditions	PT8103/5, $V_{in} = 3.3\text{V}$			Units		
			Min	Typ	Max			
Output Current	I_o	25°C , natural convection 60°C with 200LFM airflow	0.1 (1) 0.1 (1)	—	39 40	A		
Input Voltage Range	V_{in}	Over I_o Range	3.1	—	3.6	V		
Set-Point Voltage Tolerance	$V_o \text{ tol}$	Over V_o range	—	± 1	± 2	%V		
Line Regulation	ΔReg_{line}	Over V_{in} range	—	± 5	—	mV		
Load Regulation	ΔReg_{load}	Over I_o range	—	± 5	—	mV		
Temperature Variation	ΔReg_{temp}	$-40^\circ\text{C} \leq T_a \leq 85^\circ\text{C}$	—	± 0.5	—	% V_o		
Total Output Voltage Variation	$\Delta V_{o \text{ tot}}$	Includes set-point, line, load, $-40^\circ\text{C} \leq T_a \leq 85^\circ\text{C}$	—	—	± 3	%V		
Efficiency	η	$I_o = 20$	$V_o = 1.8\text{V}$	—	90	—	%	
			$V_o = 1.5\text{V}$	—	89	—		
			$V_o = 1.2\text{V}$	—	87	—		
		$I_o = 40$	$V_o = 1.8\text{V}$	—	86	—		%
			$V_o = 1.5\text{V}$	—	84	—		
			$V_o = 1.2\text{V}$	—	82	—		
V_o Ripple (pk-pk)	V_r	20MHz bandwidth	—	25	—	mV		
			Transient Response ($V_o = 1.2\text{V}$)	t_{tr}	1A/ μs load step, 50% to 100% $I_{o \text{ max}}$	—	25	—
Short Circuit Threshold	$I_{o \text{ sc}}$	Over load range	—		60	—	A	
			Switching Frequency	f_o	300	350	400	kHz
Standby Control (pin 6)	V_{IH} V_{IL}	Referenced to GND (pins 17–22)	—	—	Open (2)	V		
			Input High Voltage	-0.2	—		0.8	
			Input Low Voltage	—	0.5		—	
Input Low Current	I_{IL}	Pin 6 to GND	—	0.5	—	mA		
Standby Input Current	$I_{in \text{ standby}}$	Pin 6 to GND	—	35	—	mA		
External Output Capacitance	C_2	See application schematic	660 (5)	—	15,000	μF		
External Input Capacitance	C_1	See application schematic	1,500	—	—	μF		
Operating Temperature Range	T_a	Over V_{in} Range	-40 (3)	—	+85 (4)	$^\circ\text{C}$		
Storage Temperature	T_s	—	-40	—	+125	$^\circ\text{C}$		
Mechanical Shock	—	Per Mil-STD-883D, Method 2002.3 1 msec, Half Sine, mounted to a fixture	—	500	—	G's		
Mechanical Vibration	—	Mil-STD-883D, Method 2007.2 20–2000 Hz, soldered in PCB	Vertical	—	20 (6)	—	G's	
			Horizontal	—	20 (6)	—		
Weight	—	Vertical/Horizontal	—	55	—	grams		
Flammability	—	Materials meet UL 94V-0	—	—	—	—		

Notes: (1) ISR will operate down to no load with reduced specifications.

(2) The Standby input (pin 6) has an internal pull-up. If it is left open-circuit the module will operate when input power is applied. A low-leakage MOSFET is recommended to control this input. The open-circuit voltage is nominally 5V. See application notes for interface considerations.

(3) For operation below 0°C , C_{out} must have stable characteristics. Use either low ESR tantalum or Oscon® capacitors.

(4) See safe Operating Area curves or consult factory for the appropriate derating.

(5) The PT8100 regulators require a minimum of $660\mu\text{F}$, low ESR output capacitance ($1,200\mu\text{F}$ for standard aluminum electrolytic) for proper operation.

(6) The case pins on the through-hole package types (suffixes N & A) must be soldered. For more information see the applicable package outline drawing.

Input Filter: The filter components L_1 and C_3 are optional for most applications. The inductor must be rated to handle the projected input current. A rating of 30ADC is recommended. The input capacitance, C_1 must be rated for a minimum of 1Arms of ripple current. For transient or dynamic load applications, additional capacitance may be required. For more information refer to the application note on capacitor recommendations for this product.

PT8104 Specifications (Unless otherwise stated $T_a = 25^\circ\text{C}$, $C_1 = 1,500\mu\text{F}$, $C_2 = 660\mu\text{F}$, $V_{in} = 5\text{V}$, $V_o = 1.8\text{V}$, & $I_o = 40\text{A}$)

Characteristics	Symbols	Conditions	PT8104, $V_{in} = 5\text{V}$			Units	
			Min	Typ	Max		
Output Current	I_o	25°C , natural convection 60°C with 200LFM airflow	0.1 (1) 0.1 (1)	—	38 40	A	
Input Voltage Range	V_{in}	Over I_o Range	4.5	—	5.5	V	
Set-Point Voltage Tolerance	V_o tol	Over V_o range	—	± 1	± 2	%V	
Line Regulation	ΔReg_{line}	Over V_{in} range	—	± 10	—	mV	
Load Regulation (Droop)	ΔReg_{load}	Over I_o range	—	1.5	—	mV/A	
Temperature Variation	ΔReg_{temp}	$-40^\circ\text{C} \leq T_a \leq 85^\circ\text{C}$	—	± 0.5	—	% V_o	
Total Output Voltage Variation	$\Delta V_{o,tot}$	Includes set-point, line, load, $-40^\circ\text{C} \leq T_a \leq 85^\circ\text{C}$, pin 31 to GND	—	—	75 (2)	mV	
Efficiency	η	$I_o = 15\text{A}$	$V_o = 1.8\text{V}$	—	90	—	%
			$V_o = 1.5\text{V}$	—	88	—	
			$V_o = 1.2\text{V}$	—	87	—	
		$I_o = 40\text{A}$	$V_o = 1.8\text{V}$	—	85	—	
			$V_o = 1.5\text{V}$	—	82	—	
			$V_o = 1.2\text{V}$	—	80	—	
V_o Ripple (pk-pk)	V_r	20MHz bandwidth	—	25	—	mV	
Transient Response ($V_o = 1.2\text{V}$)	t_{tr}	1A/ μs load step, 50% to 100% I_{omax}	—	50	—	μSec	
	ΔV_{tr}	V_o over/undershoot	—	50	—	mV	
Short Circuit Threshold	I_{osc}	—	—	58	—	A	
Switching Frequency	f_o	Over load range	300	350	400	kHz	
Standby Control (pin 6) Input High Voltage Input Low Voltage Input Low Current	V_{IH} V_{IL} I_{IL}	Referenced to GND (pins 17–22) Pin 6 to GND	—	—	Open (3)	V	
			-0.2	—	0.8		
			—	0.5	—		mA
Standby Input Current	$I_{in, standby}$	Pin 6 to GND	—	35	—	mA	
External Output Capacitance	C_2	See PT8104 application schematic	660 (6)	—	15,000	μF	
External Input Capacitance	C_1	See PT8104 application schematic	1,500	—	—	μF	
Operating Temperature Range	T_a	Over V_{in} Range	-40 (4)	—	+85 (5)	$^\circ\text{C}$	
Storage Temperature	T_s	—	-40	—	+125	$^\circ\text{C}$	
Mechanical Shock	—	Per Mil-STD-883D, Method 2002.3 1 msec, Half Sine, mounted to a fixture	—	500	—	G's	
Mechanical Vibration	—	Mil-STD-883D, Method 2007.2 20-2000 Hz, soldered in PCB	Vertical	—	20 (7)	—	G's
			Horizontal	—	20 (7)	—	
Weight	—	Vertical/Horizontal	—	55	—	grams	
Flammability	—	Materials meet UL 94V-0	—	—	—	—	

Notes: (1) ISR will operate down to no load with reduced specifications.

(2) Total output voltage variation includes load regulation droop, which is required for compliance with specification V_{RM} 8.4-5

(3) The Standby input (pin 6) has an internal pull-up. If it is left open-circuit the module will operate when input power is applied. A low-leakage MOSFET is recommended to control this input. The open-circuit voltage is nominally 5V. See application notes for interface considerations.

(4) For operation below 0°C, C_{out} must have stable characteristics. Use either low ESR tantalum or Oscon® capacitors.

(5) See safe Operating Area curves or consult factory for the appropriate derating.

(6) The PT8100 regulators require a minimum of 660 μF , low ESR output capacitance (1,200 μF for standard aluminum electrolytic) for proper operation.

(7) The case pins on the through-hole package types (suffixes N & A) must be soldered. For more information see the applicable package outline drawing.

Input Filter: The filter components L_1 and C_3 are optional for most applications. The inductor must be rated to handle the projected input current. A rating of 20ADC is recommended. The input capacitance, C_1 must be rated for a minimum of 1Arms of ripple current. For transient or dynamic load applications, additional capacitance may be required. For more information refer to the application note on capacitor recommendations for this product.

Characteristic Data; $V_{in} = 5V$, PT8101/2/4 (See Note A)

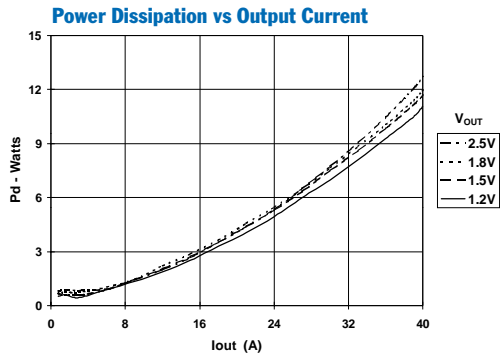
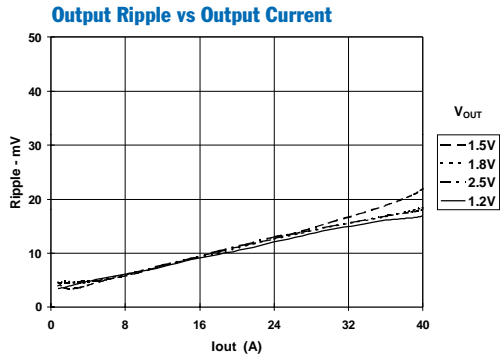
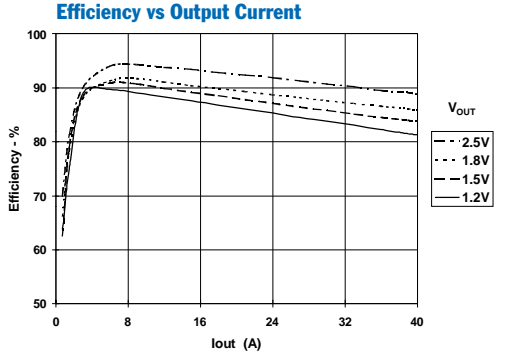

Safe Operating Area; $V_{in} = 5V$ (See Note B)

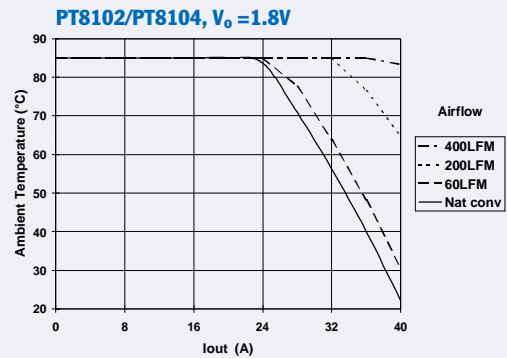
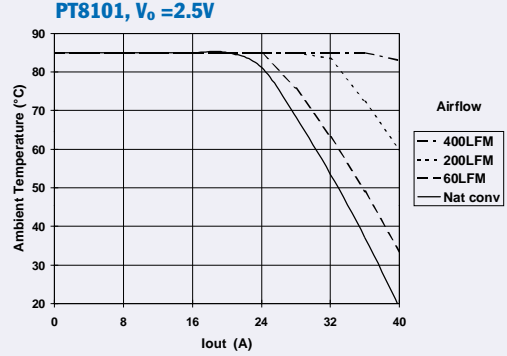

Note A: Characteristic data has been developed from actual products tested at 25°C. This data is considered typical data for the Converter.

Note B: SOA curves represent the conditions at which internal components are at or below the manufacturer's maximum operating temperatures

Characteristic Data; $V_{in} = 3.3V$, PT8103/5 (See Note A)

Safe Operating Area; $V_{in} = 3.3V$ (See Note B)

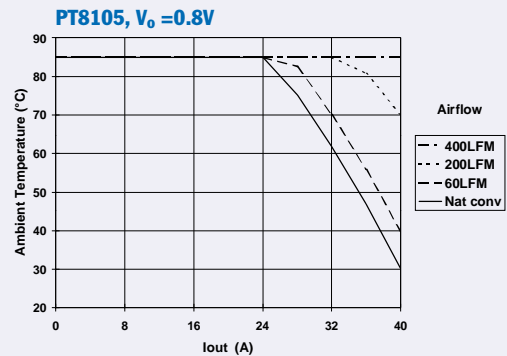
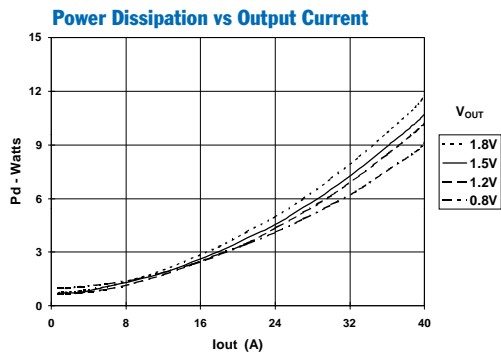
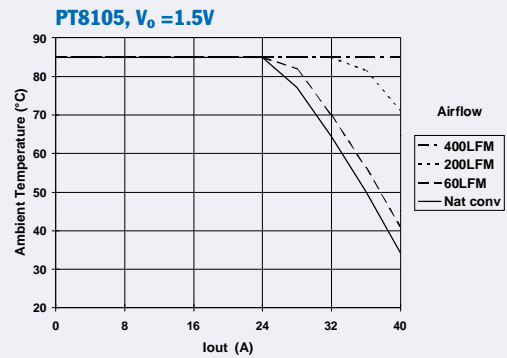
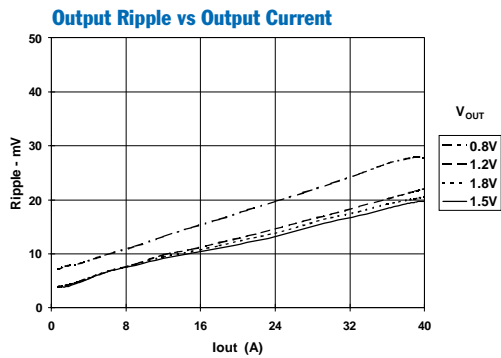
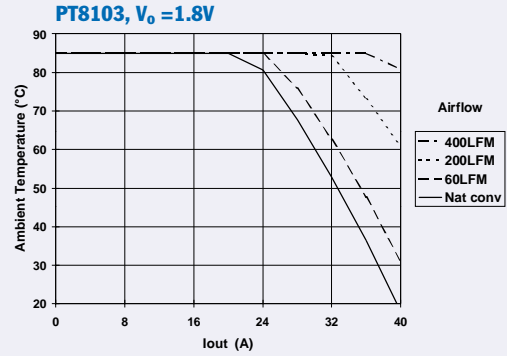
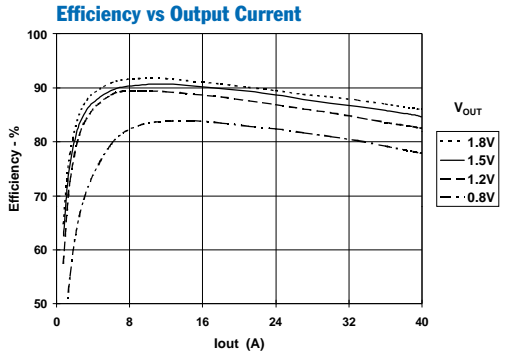

Note A: Characteristic data has been developed from actual products tested at 25°C. This data is considered typical data for the Converter.

Note B: SOA curves represent the conditions at which internal components are at or below the manufacturer's maximum operating temperatures

Capacitor Recommendations for the Non-Isolated 40-A Excalibur™ Series of Regulators

Input Capacitors

The recommended input capacitance is determined by the 1.0 ampere minimum ripple current rating and 1500µF minimum capacitance. Capacitors listed below must be rated for a minimum of 2× the input voltage with +5V operation. Ripple current and ≤100mΩ equivalent series resistance (ESR) values are the major considerations along with temperature when selecting the proper capacitor.

Output Capacitors

The minimum required output capacitance is either 660µF Oscon/Tantalum or 1200µF Aluminum Electrolytic with a maximum ESR less than or equal to 100mΩ. Failure to observe this requirement may lead to regulator instability or oscillation. Electrolytic capacitors have poor ripple performance at frequencies greater than 400kHz, but excellent low frequency transient response. Above the ripple frequency ceramic decoupling capacitors are necessary to improve the transient response and reduce any high frequency noise components apparent during higher current excursions. Preferred low ESR type capacitor part numbers are identified in Table 1 below.

Tantalum Characteristics

Tantalum capacitors with a minimum 10V rating are recommended on the output bus, but only the AVX TPS, Sprague 594/595, or Kemet T495/T510 product series. The AVX TPS, Sprague, or Kemet series capacitors are specified over other types due to their higher surge current, excellent power dissipation, and ripple current ratings. As a caution, the TAJ Series by AVX is not recommended. This series exhibits considerably higher ESR, reduced power dissipation and lower ripple current capability. The TAJ series is also less reliable compared to the TPS series when determining power dissipation capability.

Capacitor Table

Table 1 identifies the characteristics of capacitors from a number of vendors with acceptable ESR and ripple current (rms) ratings. The suggested minimum quantities per regulator for both the input and output buses are identified.

This is not an extensive capacitor list. The table below is a suggested selection guide for input and output capacitors. Other capacitor vendors are available with comparable RMS ripple current rating and ESR (Equivalent Series Resistance at 100kHz). These critical parameters are necessary to insure both optimum regulator performance and long capacitor life.

Table 1 Capacitors Characteristic Data

Capacitor Vendor Series	Capacitor Characteristics					Quantity		Vendor Number
	Working Voltage	Value(µF)	(ESR) Equivalent Series Resistance	85°C Maximum Ripple Current(Irms)	Physical Size(mm)	Input Bus	Output Bus	
Panasonic FC/FK (Surface Mount) FC (Radial)	16V	1500	0.060Ω	1100mA	12.5×13.5	1	1	EEVFK1C152Q EEVFC1C222N
	16V	2200	0.038Ω	2000mA	18×16.5	1	1	
	16V	1500	0.043Ω	1690mA	16×15	1	1	EEUFC1C152S
United Chemi-Con LXZ (Radial) FX	16V	1500	0.038Ω	1660mA	12.5×20	1	1	LXZ16VB155M12X20LL LXZ25VB182M16X20LL
	25V	1800	0.029Ω	2200mA	16×20	1	1	
	6.3V 10V	1000 680	0.013Ω 0.015Ω±2 =0.007Ω	4935mA >7000mA	10×10.5 10×10.5	1 2	1 1	6FX1000M (Vin =3.3V) 10FX680M (Os-con)
Nichicon PL Series UD Series	10V	1500	0.050Ω	1190mA	16×15	1	1	UPM1A152MHH6 UPM1A182MHH6
	10V	1800	0.044Ω	1420mA	16×15	1	1	
	10V	1000	0.09Ω	670mA×2	10×10	2	2	UUD1A102MCR1GS
Os-con: SS SVP (Surface Mount) SVP (Surface Mount)	10V	330	0.025Ω±3 =0.008Ω	>7000mA	10×10.5	3	2	10SS330M 10SVP330M 10SVP560M
	10V	330	0.017Ω±3 =0.006Ω	>7000mA	10.3×12.6	3	2	
	10V	560	0.013Ω±2 =0.065Ω	>7000mA	10×12.7	2	2	
AVX Tantalum TPS Series (Surface Mount)	10V	330	0.100Ω±3 =0.034Ω	>3500mA	7.0 L ×5.97 W	3	2	TPSV337M010R0100 TPSV337M010R0060
	10V	330	0.060Ω±3 =0.020Ω	>3500mA	×3.45 H	3	2	
Vishay/Sprague Tantalum 595D/594D Series (Surface Mount)	10V	330	0.045Ω±3 =0.015Ω	>4600mA	7.2 L ×6.0 W	3	2	594D337X0010R2T 595D687X0010R2T
	10V	680	0.090Ω±4 =0.023Ω	>2500mA	×3.5 H	2	1	
Kemet Tantalum T510/T495 /T520 (Surface Mount)	10V	330	0.035Ω±3 =0.012Ω	>5000mA	7.3 L ×4.3 W	3	1	T510X337M010AS T495X227M010AS
	10V	220	0.070Ω±5 =0.035Ω	>3000mA	×4.0 H	5	2	
Sanyo Poscap TPB (Surface Mount)	10V	220	0.040Ω±5 =0.008Ω	>3000mA	7.2 L ×4.3 W ×3.1 H	5	2	10TPB220M

Pin-Coded Output Voltage Programming of the 40-A Rated PT8100 Series Regulators

The PT8100 series of Excalibur® ISRs incorporate a pin-coded programmable output voltage. In each case the desired output voltage must be selected from a preset range defined by the regulator model. Programming is achieved by selectively connecting the control inputs, “VID0-VID4” (“VID 25mV-VID3” for PT8104), pins 1-5, to the “VID Common,” pin 11. ¹ The programming code and pinout information for each model is provided in the PT8100 specifications. Some of the program codes are compatible with the “Voltage ID” codes defined by the Intel® VRM specifications. Figure 1 shows the pin-strap connections for selecting 1.5V output voltage from a PT8101.

Notes:

1. The programming convention is as follows:-
 Logic 0: Connect to pin 11 (VID Common).
 Logic 1: Open circuit/open drain (See notes 2, & 4)
2. The output voltage range of the PT8101 is limited to 2.7V maximum. Above this voltage, the performance of the module is not guaranteed. Although the module will appear to function above this voltage, VID 4 (pin 5) should not be used to set the output voltage higher than 2.7V.
3. Do not connect pull-up resistors to the voltage programming pins.
4. To minimize output voltage error, use pin 11 (VID Common) as the logic “0” reference. However if the regulator is used to power a VRM compatible

microprocessor this may not be possible. In this case either connect pin 11 to pins 17-22, or the ground plane close to the regulator. This will allow the microprocessor to use the common ground as a VID control reference.

4. If active devices are used to ground the voltage control pins, low-level open-drain MOSFETs should be used over bipolar transistors. The inherent $V_{ce(sat)}$ in bipolar devices introduces errors in the device’s internal voltage control circuit. Discrete transistors such as the BSS138, 2N7002, IRLML2402, are examples of appropriate devices.

Active Voltage Programming:

Special precautions should be taken when making changes to the voltage control program code while the output is active. It is recommended that the ISR be powered down or placed in standby. Changes made to the program code while V_{out} is active can induce high current transients through the device. This is the result of the electrolytic output capacitors being either charged or discharged to the new output voltage set-point. The transient current can be minimized by making only incremental changes to the binary code, i.e. one LSB at a time. A minimum of 100 μ s settling time between each program state is also recommended. Making non-incremental changes to VID3 and VID4 with the output enabled is discouraged. The transients induced may activate the module’s over-current protection. When using active devices to program the output voltage, their state should be asserted prior to input power being applied. If this is not possible, pull *STBY** (pin 6) to GND during the application of power, assert the program code, then release pin 6. The release of pin 6 will then allow the device to initiate a soft-start power-up to the program voltage.

Figure 1

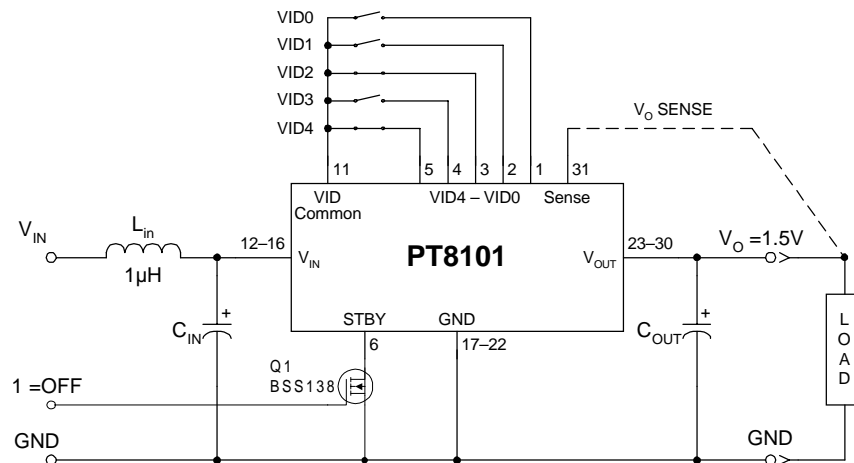

Using the On/Off Standby Function of the PT8100 Series of Programmable ISRs

The PT8100 series of programmable ISRs incorporates an On/Off Standby function. This feature may be used to turn the regulated output of the module off while input voltage is applied. This places the module in “standby” mode. The standby control may be used for power-up sequencing, or wherever there is a requirement to control the module’s output status from another circuit.

The Standby function is provided by the *STBY** control, pin 6. If pin 6 is left open-circuit the regulator operates normally, providing a regulated output when a valid supply voltage is applied to V_{in} (pins 10-16) with respect to GND (pins 17-22). Connecting pin 6 to ground¹ places the regulator in standby mode², and reduces the input current to typically 20mA. Applying a ground signal to pin 6 prior to power-up, will inhibit the output during the period that input power is applied. When the ground signal to pin 6 is removed, the regulator initiates a soft-start to re-establish the set output voltage.³ To ensure that the regulator output is properly enabled, the *STBY** control pin must be open circuit.

Table 1 Standby Control Requirements²

Parameter	Min	Typ	Max
V_{IH}	—		Open Cct. ¹
V_{IL}	-0.2V	—	0.8V
I_{STBY}		-0.5mA	

Notes:

1. The standby on a PT8100 series regulators must be controlled with an open-collector (or open-drain) transistor (See fig. 1). *Do Not* use a pull-up resistor. Table 1 gives the *STBY** pin parameters. The control pin has an open-circuit voltage equal to V_{in} . To shut the regulator output off, the control pin must be “pulled” to less than 0.8Vdc with a low-impedance sink to ground.

2. In the standby mode the output of the regulator is tri-state, and the output voltage falls at the rate that the load circuit discharges the output filter capacitors.
3. When the ground signal to the *Standby* pin is removed, the regulator output initiates a soft-start cycle by first asserting a low impedance to ground. If an external voltage is applied to the output bus, it will sink current and possibly over-stress the part.

Turn-On Time

Turning Q_1 in Figure 1 off, removes the low-voltage signal at pin 6. After approximately 4ms the regulator output rises and reaches full regulation within 10ms. Fig. 2 shows the typical waveforms of a PT8101 following the prompt turn-off of Q_1 . The turn-off of Q_1 corresponds to the rise in V_{stby} . The output voltage was set to 1.8V, and the waveforms were measured with a 5V input source, and 9.25A resistive load.

Figure 2

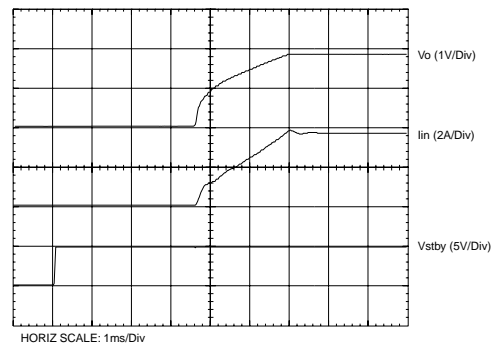
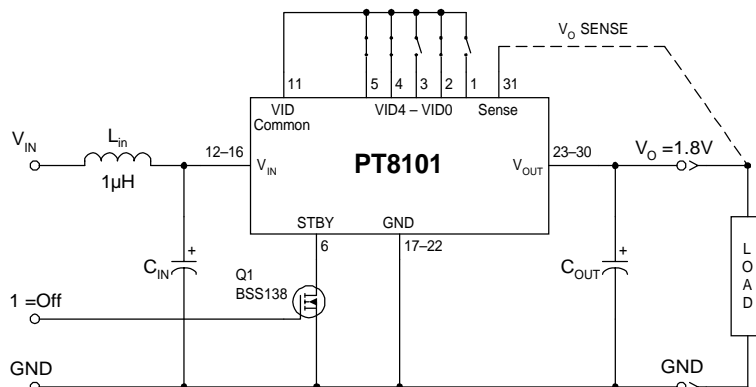

Figure 1



PACKAGING INFORMATION

Orderable Device	Status ⁽¹⁾	Package Type	Package Drawing	Pins	Package Qty	Eco Plan ⁽²⁾	Lead/Ball Finish	MSL Peak Temp ⁽³⁾
PT8101A	NRND	SIP MOD ULE	EKF	31	6	TBD	Call TI	Level-1-215C-UNLIM
PT8101C	NRND	SIP MOD ULE	EKG	31	6	TBD	Call TI	Level-3-215C-168HRS
PT8101N	NRND	SIP MOD ULE	EKH	31		TBD	Call TI	Call TI
PT8102A	NRND	SIP MOD ULE	EKF	31	6	TBD	Call TI	Level-1-215C-UNLIM
PT8102C	NRND	SIP MOD ULE	EKG	31		TBD	Call TI	Call TI
PT8102N	NRND	SIP MOD ULE	EKH	31	6	TBD	Call TI	Level-1-215C-UNLIM
PT8103A	NRND	SIP MOD ULE	EKF	31		TBD	Call TI	Call TI
PT8103C	ACTIVE	SIP MOD ULE	EKG	31	6	TBD	Call TI	Level-3-215C-168HRS
PT8103N	ACTIVE	SIP MOD ULE	EKH	31	6	TBD	Call TI	Level-1-215C-UNLIM
PT8104A	NRND	SIP MOD ULE	EKF	31		TBD	Call TI	Call TI
PT8104C	NRND	SIP MOD ULE	EKG	31		TBD	Call TI	Call TI
PT8105A	NRND	SIP MOD ULE	EKF	31	6	TBD	Call TI	Level-1-215C-UNLIM
PT8105C	NRND	SIP MOD ULE	EKG	31		TBD	Call TI	Call TI
PT8105N	NRND	SIP MOD ULE	EKH	31		TBD	Call TI	Call TI

⁽¹⁾ The marketing status values are defined as follows:

ACTIVE: Product device recommended for new designs.

LIFEBUY: TI has announced that the device will be discontinued, and a lifetime-buy period is in effect.

NRND: Not recommended for new designs. Device is in production to support existing customers, but TI does not recommend using this part in a new design.

PREVIEW: Device has been announced but is not in production. Samples may or may not be available.

OBSELETE: TI has discontinued the production of the device.

⁽²⁾ Eco Plan - The planned eco-friendly classification: Pb-Free (RoHS), Pb-Free (RoHS Exempt), or Green (RoHS & no Sb/Br) - please check <http://www.ti.com/productcontent> for the latest availability information and additional product content details.

TBD: The Pb-Free/Green conversion plan has not been defined.

Pb-Free (RoHS): TI's terms "Lead-Free" or "Pb-Free" mean semiconductor products that are compatible with the current RoHS requirements for all 6 substances, including the requirement that lead not exceed 0.1% by weight in homogeneous materials. Where designed to be soldered at high temperatures, TI Pb-Free products are suitable for use in specified lead-free processes.

Pb-Free (RoHS Exempt): This component has a RoHS exemption for either 1) lead-based flip-chip solder bumps used between the die and package, or 2) lead-based die adhesive used between the die and leadframe. The component is otherwise considered Pb-Free (RoHS compatible) as defined above.

Green (RoHS & no Sb/Br): TI defines "Green" to mean Pb-Free (RoHS compatible), and free of Bromine (Br) and Antimony (Sb) based flame retardants (Br or Sb do not exceed 0.1% by weight in homogeneous material)

⁽³⁾ MSL, Peak Temp. -- The Moisture Sensitivity Level rating according to the JEDEC industry standard classifications, and peak solder temperature.

Important Information and Disclaimer:The information provided on this page represents TI's knowledge and belief as of the date that it is

provided. TI bases its knowledge and belief on information provided by third parties, and makes no representation or warranty as to the accuracy of such information. Efforts are underway to better integrate information from third parties. TI has taken and continues to take reasonable steps to provide representative and accurate information but may not have conducted destructive testing or chemical analysis on incoming materials and chemicals. TI and TI suppliers consider certain information to be proprietary, and thus CAS numbers and other limited information may not be available for release.

In no event shall TI's liability arising out of such information exceed the total purchase price of the TI part(s) at issue in this document sold by TI to Customer on an annual basis.

IMPORTANT NOTICE

Texas Instruments Incorporated and its subsidiaries (TI) reserve the right to make corrections, modifications, enhancements, improvements, and other changes to its products and services at any time and to discontinue any product or service without notice. Customers should obtain the latest relevant information before placing orders and should verify that such information is current and complete. All products are sold subject to TI's terms and conditions of sale supplied at the time of order acknowledgment.

TI warrants performance of its hardware products to the specifications applicable at the time of sale in accordance with TI's standard warranty. Testing and other quality control techniques are used to the extent TI deems necessary to support this warranty. Except where mandated by government requirements, testing of all parameters of each product is not necessarily performed.

TI assumes no liability for applications assistance or customer product design. Customers are responsible for their products and applications using TI components. To minimize the risks associated with customer products and applications, customers should provide adequate design and operating safeguards.

TI does not warrant or represent that any license, either express or implied, is granted under any TI patent right, copyright, mask work right, or other TI intellectual property right relating to any combination, machine, or process in which TI products or services are used. Information published by TI regarding third-party products or services does not constitute a license from TI to use such products or services or a warranty or endorsement thereof. Use of such information may require a license from a third party under the patents or other intellectual property of the third party, or a license from TI under the patents or other intellectual property of TI.

Reproduction of information in TI data books or data sheets is permissible only if reproduction is without alteration and is accompanied by all associated warranties, conditions, limitations, and notices. Reproduction of this information with alteration is an unfair and deceptive business practice. TI is not responsible or liable for such altered documentation.

Resale of TI products or services with statements different from or beyond the parameters stated by TI for that product or service voids all express and any implied warranties for the associated TI product or service and is an unfair and deceptive business practice. TI is not responsible or liable for any such statements.

Following are URLs where you can obtain information on other Texas Instruments products and application solutions:

Products		Applications	
Amplifiers	amplifier.ti.com	Audio	www.ti.com/audio
Data Converters	dataconverter.ti.com	Automotive	www.ti.com/automotive
DSP	dsp.ti.com	Broadband	www.ti.com/broadband
Interface	interface.ti.com	Digital Control	www.ti.com/digitalcontrol
Logic	logic.ti.com	Military	www.ti.com/military
Power Mgmt	power.ti.com	Optical Networking	www.ti.com/opticalnetwork
Microcontrollers	microcontroller.ti.com	Security	www.ti.com/security
Low Power Wireless	www.ti.com/lpw	Telephony	www.ti.com/telephony
		Video & Imaging	www.ti.com/video
		Wireless	www.ti.com/wireless

Mailing Address: Texas Instruments
Post Office Box 655303 Dallas, Texas 75265