

LOW-NOISE, HIGH-SPEED CURRENT FEEDBACK AMPLIFIERS

FEATURES

- **Low Noise**
 - 2.9 pA/√Hz Noninverting Current Noise
 - 10.8 pA/√Hz Inverting Current Noise
 - 2.2 nV/√Hz Voltage Noise
- **Wide Supply Voltage Range** ±5 V to ±15 V
- **Wide Output Swing**
 - 25 V_{PP} Output Voltage, R_L = 100 Ω, ±15-V Supply
- **High Output Current, 150 mA (Min)**
- **High Speed**
 - 110 MHz (–3 dB, G=1, ±15 V)
 - 1550 V/μs Slew Rate (G = 2, ±15 V)
- **Low Distortion, G = 2**
 - –78 dBc (1 MHz, 2 V_{PP}, 100-Ω load)
- **Low Power Shutdown (THS3115)**
 - 300-μA Shutdown Quiescent Current Per Channel
- **Thermal Shutdown and Short Circuit Protection**
- **Standard SOIC, SOIC PowerPAD™, and TSSOP PowerPAD™ Package**
- **Evaluation Module Available**

APPLICATIONS

- **Communication Equipment**
- **Video Distribution**
- **Motor Drivers**
- **Piezo Drivers**

DESCRIPTION

The THS3112/5 are low-noise, high-speed current feedback amplifiers, ideal for any application requiring high output current. The low noninverting current noise of 2.9 pA/√Hz and the low inverting current noise of 10.8 pA/√Hz increase signal to noise ratios for enhanced signal resolution. The THS3112/5 can operate from ±5-V to ±15-V supply voltages, while drawing as little as 4.5 mA of supply current per channel. It offers low –78-dBc total harmonic distortion driving 2 V_{PP} into a 100-Ω load. The THS3115 features a low power shutdown mode, consuming only 300-μA shutdown quiescent current per channel. The THS3112/5 is packaged in a standard SOIC, SOIC PowerPAD™, and TSSOP PowerPAD packages.

VOLTAGE NOISE AND CURRENT NOISE

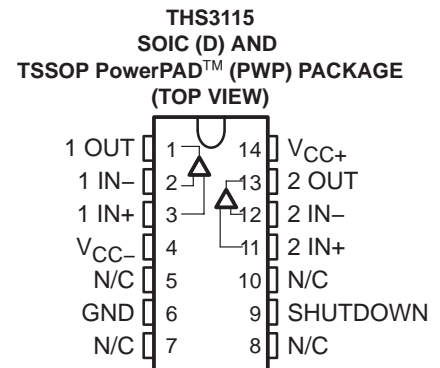
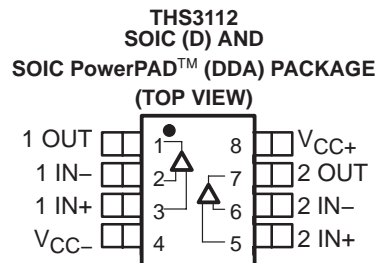
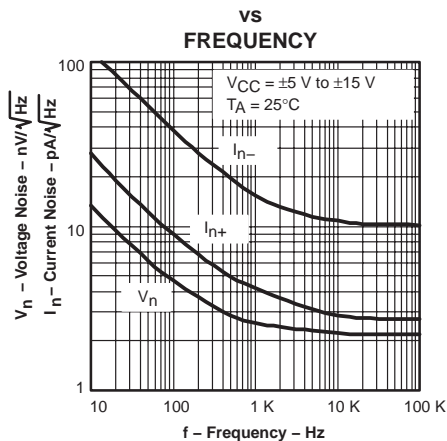

Please be aware that an important notice concerning availability, standard warranty, and use in critical applications of Texas Instruments semiconductor products and disclaimers thereto appears at the end of this data sheet.

PowerPAD is a trademark of Texas Instruments.

PRODUCTION DATA information is current as of publication date. Products conform to specifications per the terms of Texas Instruments standard warranty. Production processing does not necessarily include testing of all parameters.

AVAILABLE OPTIONS

T _A	PACKAGED DEVICE				EVALUATION MODULES
	SOIC-8 (D)	SOIC-8 PowerPAD (DDA)	SOIC-14 (D)	TSSOP-14 (PWP)	
0°C to 70°C	THS3112CD	THS3112CDDA	THS3115CD	THS3115CPWP	THS3112EVM
-40°C to 85°C	THS3112ID	THS3112IDDA	THS3115ID	THS3115IPWP	THS3115EVM

absolute maximum ratings over operating free-air temperature (unless otherwise noted)†

Supply voltage, V _{CC+} to V _{CC-}	33 V
Input voltage	± V _{CC}
Output current (see Note 1)	275 mA
Differential input voltage	± 4 V
Maximum junction temperature	150°C
Total power dissipation at (or below) 25°C free-air temperature	See Dissipation Ratings Table
Operating free-air temperature, T _A : Commercial	0°C to 70°C
Industrial	-40°C to 85°C
Storage temperature, T _{stg} : Commercial	-65°C to 125°C
Industrial	-65°C to 125°C
Lead temperature 1,6 mm (1/16 inch) from case for 10 seconds	300°C

† Stresses beyond those listed under “absolute maximum ratings” may cause permanent damage to the device. These are stress ratings only, and functional operation of the device at these or any other conditions beyond those indicated under “recommended operating conditions” is not implied. Exposure to absolute-maximum-rated conditions for extended periods may affect device reliability.

NOTE 1: The THS3112 and THS3115 may incorporate a PowerPAD™ on the underside of the chip. This acts as a heatsink and must be connected to a thermally dissipating plane for proper power dissipation. Failure to do so may result in exceeding the maximum junction temperature which could permanently damage the device. See TI Technical Brief SLMA002 for more information about utilizing the PowerPAD™ thermally enhanced package.

DISSIPATION RATING TABLE

PACKAGE	θ _{JA}	T _A = 25°C POWER RATING
D-8	95°C/W‡	1.32 W
DDA	67°C/W	1.87 W
D-14	66.6°C/W‡	1.88 W
PWP	37.5°C/W	3.3 W

‡ This data was taken using the JEDEC proposed high-K test PCB. For the JEDEC low-K test PCB, the θ_{JA} is 168°C/W for the D-8 package and 122.3°C/W for the D-14 package.

recommended operating conditions

		MIN	NOM	MAX	UNIT
Supply voltage, V _{CC+} to V _{CC-}	Dual supply	±5		±15	V
	Single supply	10		30	
Operating free-air temperature, T _A	C-suffix	0		70	°C
	I-suffix	-40		85	
Shutdown pin input levels, relative to the GND pin	High level (device shutdown)	2			V
	Low level (device active)			0.8	

electrical characteristics over recommended operating free-air temperature range, $T_A = 25^\circ\text{C}$, $V_{CC} = \pm 15\text{ V}$, $R_F = 750\ \Omega$, $R_L = 100\ \Omega$ (unless otherwise noted)

dynamic performance

PARAMETER		TEST CONDITIONS			MIN	TYP	MAX	UNIT
BW	Small-signal bandwidth (-3 dB)	$R_L = 100\ \Omega$	$R_F = 1\ \text{k}\Omega$, $G = 1$	$V_{CC} = \pm 5\text{ V}$		95	MHz	
				$V_{CC} = \pm 15\text{ V}$		110		
		$R_L = 100\ \Omega$	$R_F = 750\ \Omega$, $G = 2$	$V_{CC} = \pm 5\text{ V}$		103		
				$V_{CC} = \pm 15\text{ V}$		110		
	Bandwidth (0.1 dB)		$R_F = 750\ \Omega$, $G = 2$	$V_{CC} = \pm 5\text{ V}$		25		
				$V_{CC} = \pm 15\text{ V}$		48		
SR	Slew rate (see Note 2), $G=8$	$G = 2$ $R_F = 680\ \Omega$	$V_O = 10\text{ V}_{PP}$	$V_{CC} = \pm 15\text{ V}$		1550	$\text{V}/\mu\text{s}$	
			$V_O = 5\text{ V}_{PP}$	$V_{CC} = \pm 5\text{ V}$		820		
				$V_{CC} = \pm 15\text{ V}$		1300		
t_s	Settling time to 0.1%	$G = -1$	$V_O = 2\text{ V}_{PP}$	$V_{CC} = \pm 5\text{ V}$		50	ns	
			$V_O = 5\text{ V}_{PP}$	$V_{CC} = \pm 15\text{ V}$		63		

NOTE 2: Slew rate is defined from the 25% to the 75% output levels.

noise/distortion performance

PARAMETER		TEST CONDITIONS			MIN	TYP	MAX	UNIT
THD	Total harmonic distortion	$G = 2$, $R_F = 680\ \Omega$, $V_{CC} = \pm 15\text{ V}$, $f = 1\ \text{MHz}$	$V_O(PP) = 2\text{ V}$			-78	dBc	
			$V_O(PP) = 8\text{ V}$			-75		
		$G = 2$, $R_F = 680\ \Omega$, $V_{CC} = \pm 5\text{ V}$, $f = 1\ \text{MHz}$	$V_O(PP) = 2\text{ V}$			-76		
			$V_O(PP) = 6\text{ V}$			-74		
V_n	Input voltage noise	$V_{CC} = \pm 5\text{ V}, \pm 15\text{ V}$		$f = 10\ \text{kHz}$		2.2	$\text{nV}/\sqrt{\text{Hz}}$	
I_n	Input current noise	Noninverting Input	$V_{CC} = \pm 5\text{ V}, \pm 15\text{ V}$		$f = 10\ \text{kHz}$		2.9	$\text{pA}/\sqrt{\text{Hz}}$
		Inverting Input					10.8	
Crosstalk		$G = 2$, $f = 1\ \text{MHz}$, $V_O = 2\text{ V}_{pp}$	$V_{CC} = \pm 5\text{ V}$			-67	dBc	
			$V_{CC} = \pm 15\text{ V}$			-67		
Differential gain error		$G = 2$, $R_L = 150\ \Omega$ 40 IRE modulation	$V_{CC} = \pm 5\text{ V}$			0.01%		
			$V_{CC} = \pm 15\text{ V}$			0.01%		
Differential phase error		$\pm 100\ \text{IRE Ramp}$ NTSC and PAL	$V_{CC} = \pm 5\text{ V}$			0.011°		
			$V_{CC} = \pm 15\text{ V}$			0.011°		

electrical characteristics over recommended operating free-air temperature range, $T_A = 25^\circ\text{C}$, $V_{CC} = \pm 15\text{ V}$, $R_F = 750\ \Omega$, $R_L = 100\ \Omega$ (unless otherwise noted) (continued)

dc performance

PARAMETER		TEST CONDITIONS		MIN	TYP	MAX	UNIT
V_{IO}	Input offset voltage	$V_{CC} = \pm 5\text{ V}$, $V_{CC} = \pm 15\text{ V}$	$T_A = 25^\circ\text{C}$		3	8	mV
			$T_A = \text{full range}$			13	
	Channel offset voltage matching		$T_A = 25^\circ\text{C}$		1	3	
			$T_A = \text{full range}$			4	
	Offset drift		$T_A = \text{full range}$		10		$\mu\text{V}/^\circ\text{C}$
I_{IB}	– Input bias current	$V_{CC} = \pm 5\text{ V}$, $V_{CC} = \pm 15\text{ V}$	$T_A = 25^\circ\text{C}$			23	μA
			$T_A = \text{full range}$			30	
	+ Input bias current		$T_A = 25^\circ\text{C}$		0.33	2	
			$T_A = \text{full range}$			3	
	Input offset current		$T_A = 25^\circ\text{C}$			4	
$T_A = \text{full range}$					30		
Z_{OL}	Open loop transimpedance	$V_{CC} = \pm 5\text{ V}$, $V_{CC} = \pm 15\text{ V}$	$R_L = 1\text{ k}\Omega$,		1		$\text{M}\Omega$

input characteristics

PARAMETER		TEST CONDITIONS		MIN	TYP	MAX	UNIT
V_{ICR}	Input common-mode voltage range	$V_{CC} = \pm 5\text{ V}$	$T_A = \text{full range}$	± 2.5	± 2.7		V
		$V_{CC} = \pm 15\text{ V}$		± 12.5	± 12.7		
CMRR	Common-mode rejection ratio	$V_{CC} = \pm 5\text{ V}$, $V_I = -2.5\text{ V to } 2.5\text{ V}$	$T_A = 25^\circ\text{C}$	56	62		dB
			$T_A = \text{full range}$	54			
		$V_{CC} = \pm 15\text{ V}$, $V_I = -12.5\text{ V to } 12.5\text{ V}$	$T_A = 25^\circ\text{C}$	63	67		
			$T_A = \text{full range}$	60			
R_I	Input resistance	+ Input			1.5		$\text{M}\Omega$
		– Input			15		Ω
C_i	Input capacitance				2		pF

output characteristics

PARAMETER		TEST CONDITIONS		MIN	TYP	MAX	UNIT
V_O	Output voltage swing	$G = 4$, $V_I = 1\text{ V}$, $V_{CC} = \pm 5\text{ V}$	$R_L = 1\text{ k}\Omega$, $T_A = 25^\circ\text{C}$		3.9		V
			$R_L = 100\ \Omega$,	$T_A = 25^\circ\text{C}$	3.6	3.8	
				$T_A = \text{full range}$	3.4		
		$G = 4$, $V_I = 3.4\text{ V}$, $V_{CC} = \pm 15\text{ V}$	$R_L = 1\text{ k}\Omega$, $T_A = 25^\circ\text{C}$		13.5		
			$R_L = 100\ \Omega$,	$T_A = 25^\circ\text{C}$	12.2	13.3	
				$T_A = \text{full range}$	12		
I_O	Output current drive	$G = 4$, $V_I = 0.9\text{ V}$, $V_{CC} = \pm 5\text{ V}$	$R_L = 25\ \Omega$,	$T_A = 25^\circ\text{C}$	100	130	mA
		$G = 4$, $V_I = 1.7\text{ V}$, $V_{CC} = \pm 15\text{ V}$	$R_L = 25\ \Omega$,		175	270	
r_o	Output resistance	open loop			14		Ω

electrical characteristics over recommended operating free-air temperature range, $T_A = 25^\circ\text{C}$, $V_{CC} = \pm 15\text{ V}$, $R_F = 750\ \Omega$, $R_L = 100\ \Omega$, $GND = 0\text{ V}$ (unless otherwise noted) (continued)

power supply

PARAMETER		TEST CONDITIONS		MIN	TYP	MAX	UNIT
I_{CC}	Quiescent current (per amplifier)	$V_{CC} = \pm 5\text{ V}$	$T_A = 25^\circ\text{C}$	4.4	5.5	mA	
			$T_A = \text{full range}$	6			
		$V_{CC} = \pm 15\text{ V}$	$T_A = 25^\circ\text{C}$	4.9	6.5		
			$T_A = \text{full range}$	7.5			
PSRR	Power supply rejection ratio	$V_{CC} = \pm 5\text{ V}$	$T_A = 25^\circ\text{C}$	53	60	dB	
			$T_A = \text{full range}$	50			
		$V_{CC} = \pm 15\text{ V}$	$T_A = 25^\circ\text{C}$	68	74		
			$T_A = \text{full range}$	66			

shutdown characteristics (THS3115 only)

PARAMETER		TEST CONDITIONS		MIN	TYP	MAX	UNIT
$I_{CC}(\text{SHDN})$	Shutdown quiescent current (per channel)	$V_{GND} = 0\text{ V}$, $V_{CC} = \pm 5\text{ V}$, $\pm 15\text{ V}$			0.3	0.45	mA
t_{DIS}	Disable time (see Note 3)	$V_{CC} = \pm 15\text{ V}$			200		ns
t_{EN}	Enable time (see Note 3)	$V_{CC} = \pm 15\text{ V}$			300		ns
$I_{IL}(\text{SHDN})$	Shutdown pin input bias current for power up	$V_{CC} = \pm 5\text{ V}$, $\pm 15\text{ V}$, $V(\text{SHDN}) = 0\text{ V}$			18	25	μA
$I_{IH}(\text{SHDN})$	Shutdown pin input bias current for power down	$V_{CC} = \pm 5\text{ V}$, $\pm 15\text{ V}$, $V(\text{SHDN}) = 3.3\text{ V}$			110	130	μA

NOTE 3: Disable/enable time is defined as the time from when the shutdown signal is applied to the SHDN pin to when the supply current has reached half of its final value.

TYPICAL CHARACTERISTICS

Table of Graphs

			FIGURE
	Small signal closed loop gain	vs Frequency	1 – 11, 13, 14
	Gain and phase	vs Frequency	12
	Small signal closed loop noninverting gain	vs Frequency	15, 16
	Small signal closed loop inverting gain	vs Frequency	17, 18
	Small and large signal output	vs Frequency	19, 20
	Harmonic distortion	vs Frequency	21, 22
		vs Peak-to-peak output voltage	23, 24
V_n, I_n	Voltage noise and current noise	vs Frequency	25
CMRR	Common-mode rejection ratio	vs Frequency	26
PSRR	Power supply rejection ratio	vs Frequency	27
	Crosstalk	vs Frequency	28
Z_o	Output impedance	vs Frequency	29
SR	Slew rate	vs Output voltage step	30
V_{IO}	Input offset voltage	vs Free-air temperature	31
		vs Common-mode input voltage	32
I_B	Input bias current	vs Free-air temperature	33
V_O	Output voltage	vs Output current	34, 35
		Output voltage headroom	vs Output current
I_{CC}	Supply current (per channel)	vs Supply voltage	37
		Shutdown response	38

TYPICAL CHARACTERISTICS

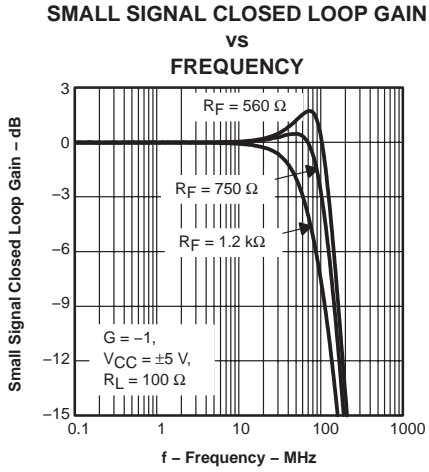

Figure 1

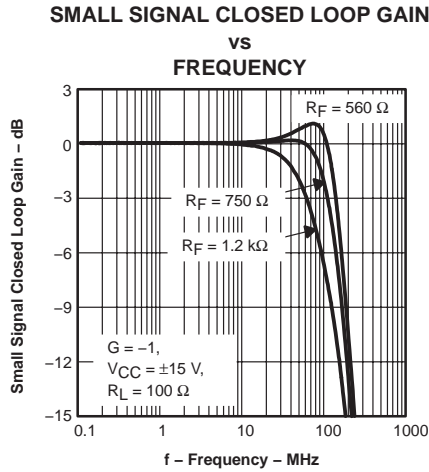

Figure 2

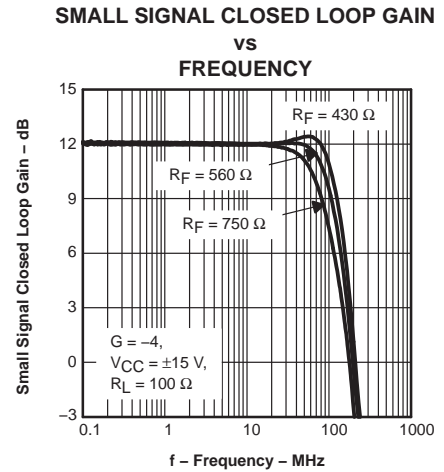

Figure 3

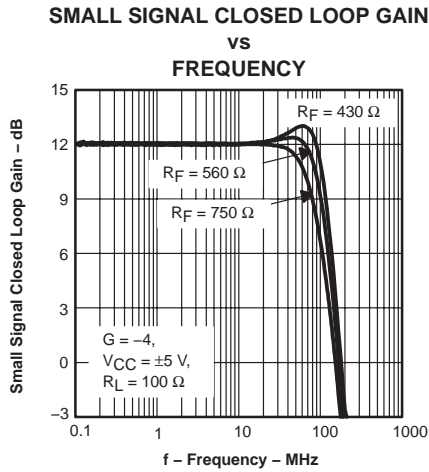

Figure 4

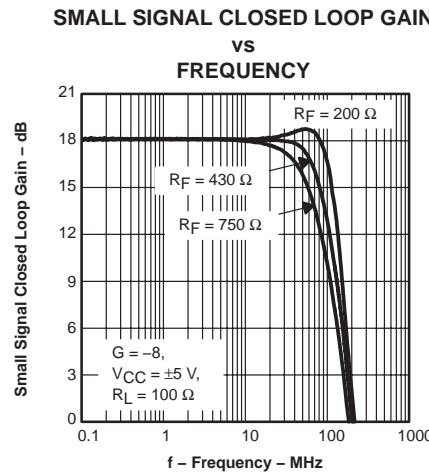

Figure 5

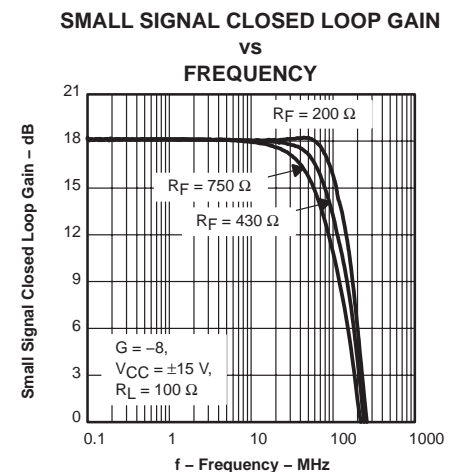

Figure 6

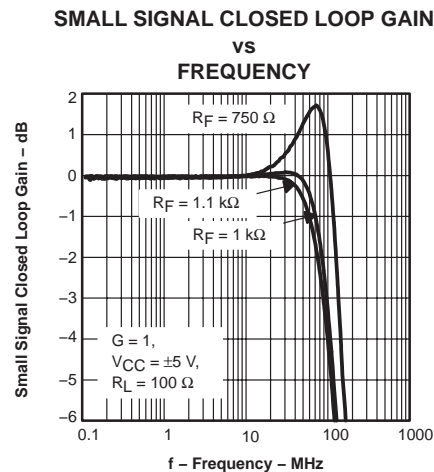

Figure 7

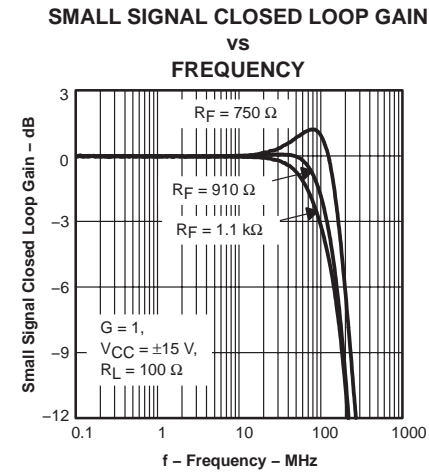

Figure 8

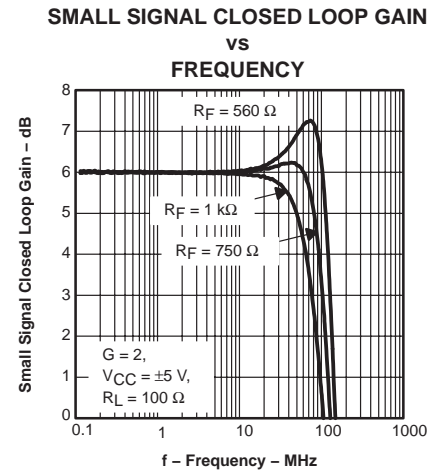

Figure 9

TYPICAL CHARACTERISTICS

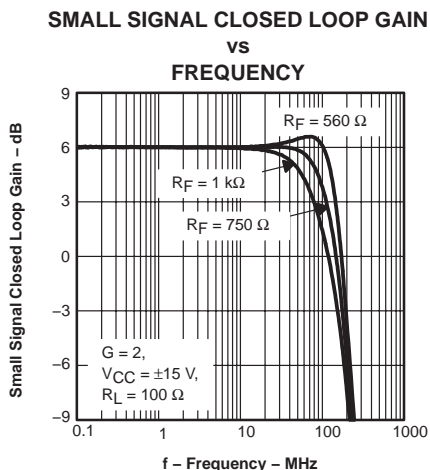

Figure 10

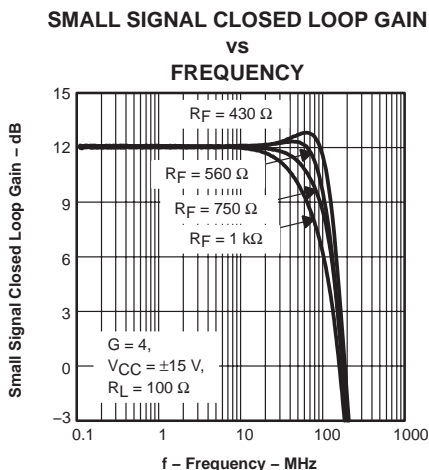

Figure 11

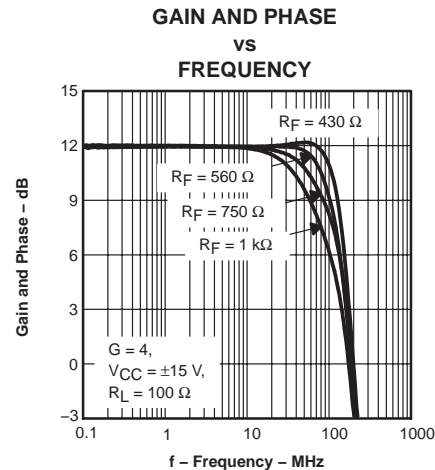

Figure 12

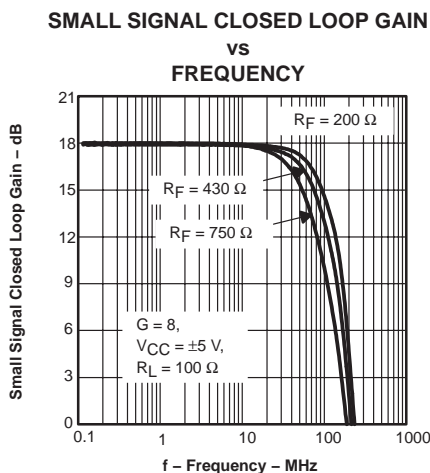

Figure 13

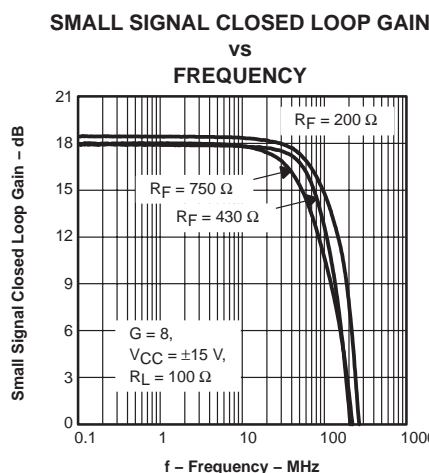

Figure 14

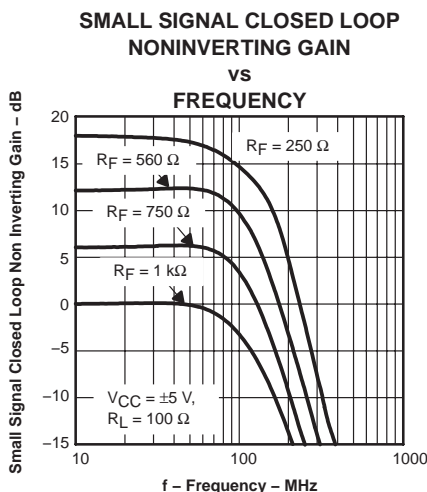

Figure 15

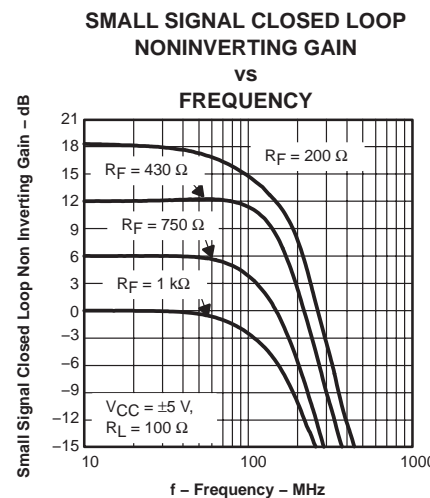

Figure 16

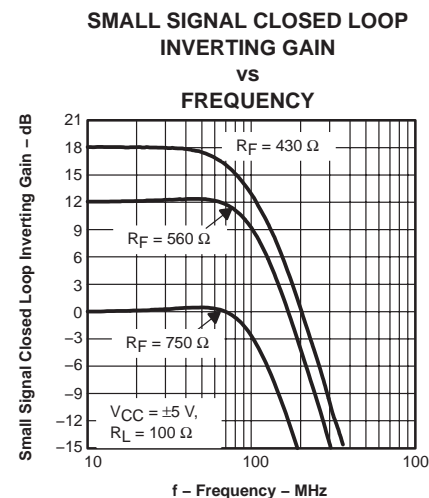

Figure 17

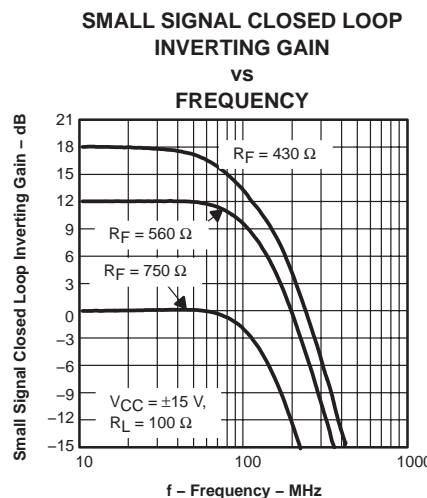

Figure 18

TYPICAL CHARACTERISTICS

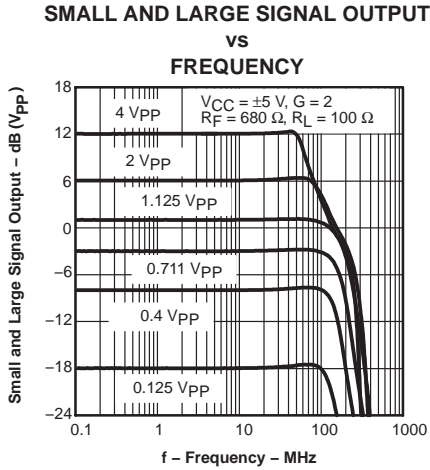

Figure 19

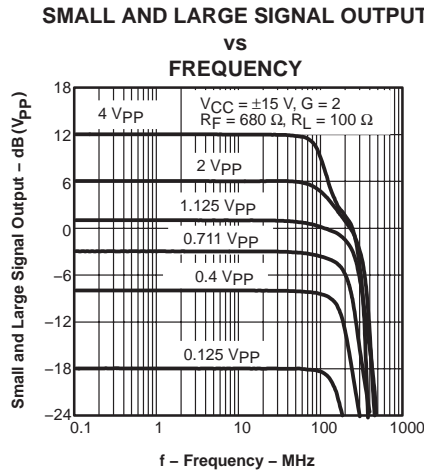

Figure 20

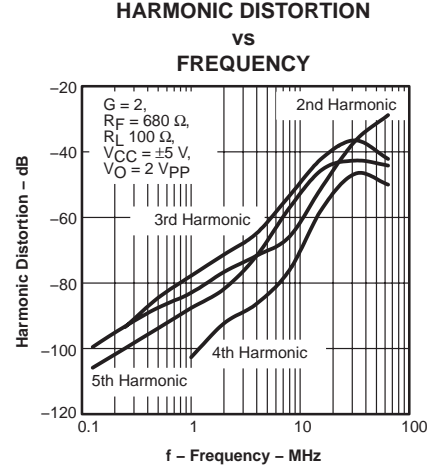

Figure 21

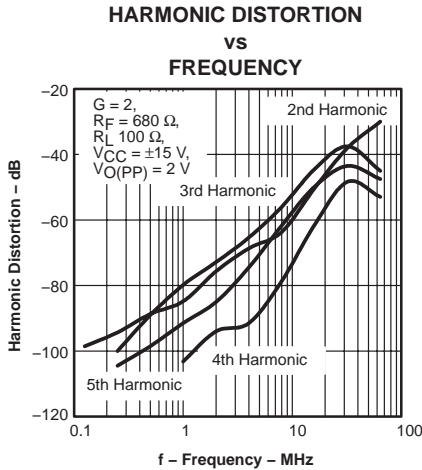

Figure 22

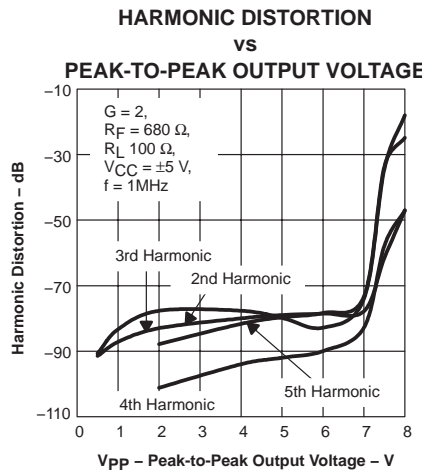

Figure 23

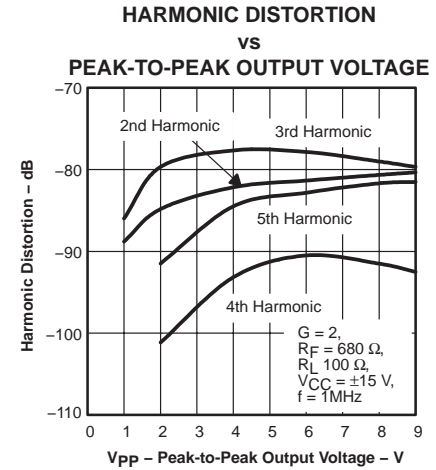

Figure 24

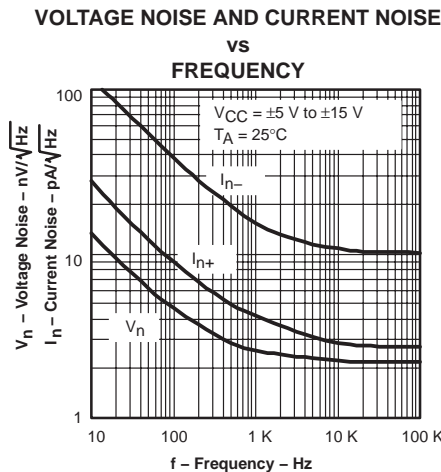

Figure 25

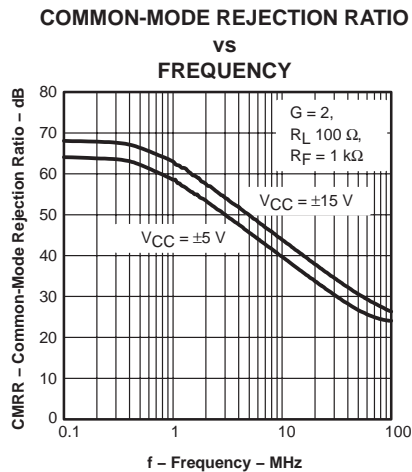

Figure 26

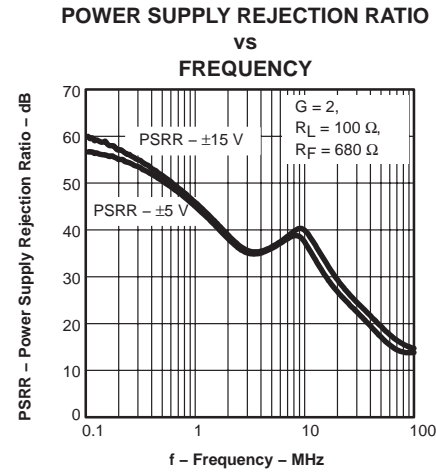

Figure 27

TYPICAL CHARACTERISTICS

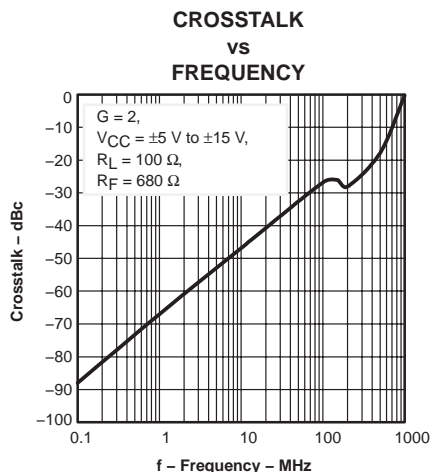

Figure 28

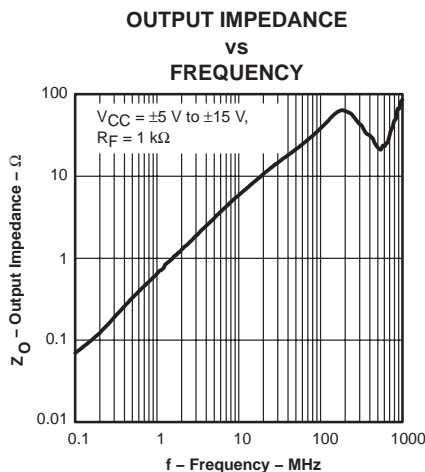

Figure 29

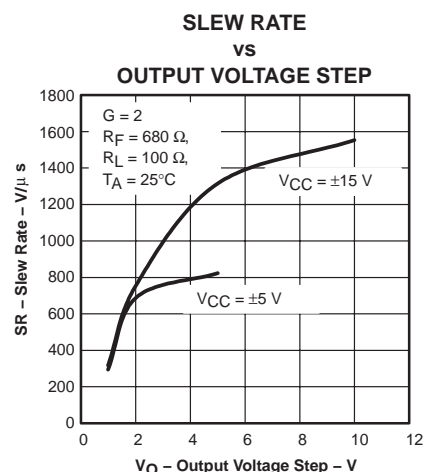

Figure 30

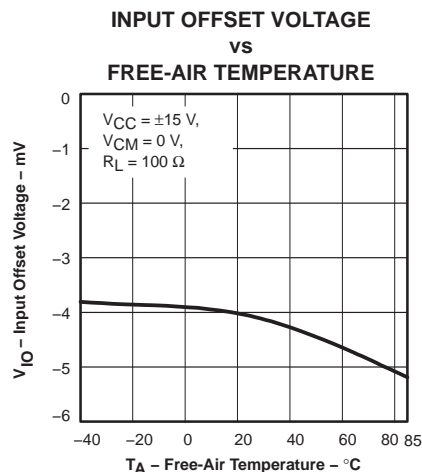

Figure 31

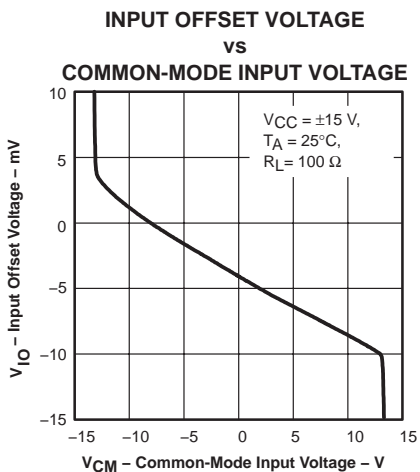

Figure 32

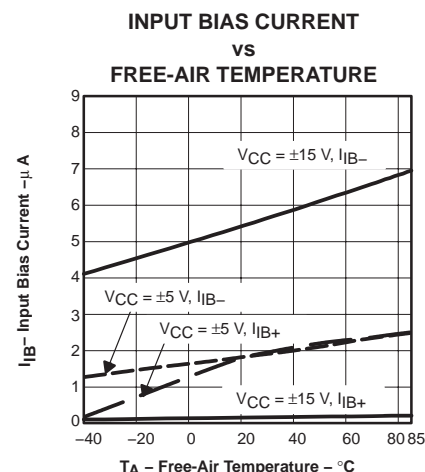

Figure 33

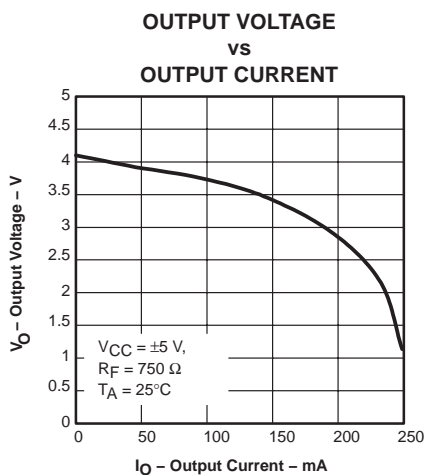

Figure 34

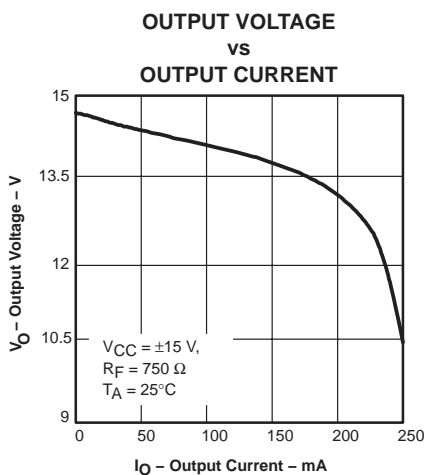

Figure 35

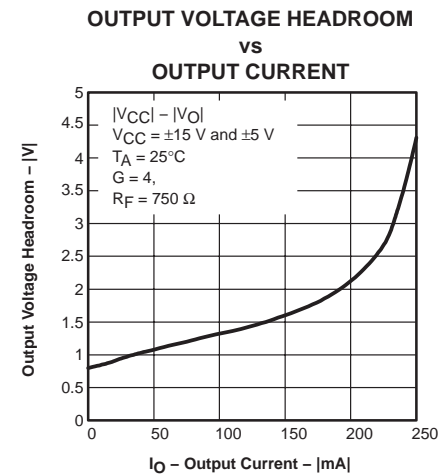
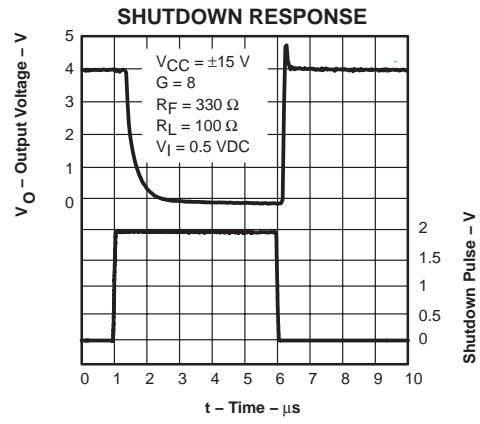
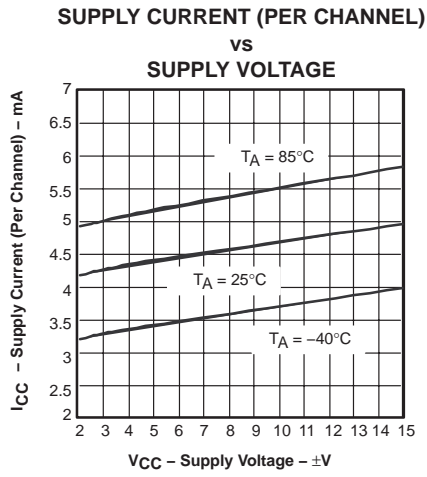

Figure 36

TYPICAL CHARACTERISTICS



PACKAGING INFORMATION

Orderable Device	Status ⁽¹⁾	Package Type	Package Drawing	Pins	Package Qty	Eco Plan ⁽²⁾	Lead/Ball Finish	MSL Peak Temp ⁽³⁾
THS3112CD	ACTIVE	SOIC	D	8	75	Green (RoHS & no Sb/Br)	CU NIPDAU	Level-1-260C-UNLIM
THS3112CDDA	ACTIVE	SO Power PAD	DDA	8	75	Green (RoHS & no Sb/Br)	CU SN	Level-1-260C-UNLIM
THS3112CDDAG3	ACTIVE	SO Power PAD	DDA	8	75	Green (RoHS & no Sb/Br)	CU SN	Level-1-260C-UNLIM
THS3112CDDAR	ACTIVE	SO Power PAD	DDA	8	2500	Green (RoHS & no Sb/Br)	CU SN	Level-1-260C-UNLIM
THS3112CDDARG3	ACTIVE	SO Power PAD	DDA	8	2500	Green (RoHS & no Sb/Br)	CU SN	Level-1-260C-UNLIM
THS3112CDG4	ACTIVE	SOIC	D	8	75	Green (RoHS & no Sb/Br)	CU NIPDAU	Level-1-260C-UNLIM
THS3112CDR	ACTIVE	SOIC	D	8	2500	Green (RoHS & no Sb/Br)	CU NIPDAU	Level-1-260C-UNLIM
THS3112CDRG4	ACTIVE	SOIC	D	8	2500	Green (RoHS & no Sb/Br)	CU NIPDAU	Level-1-260C-UNLIM
THS3112ID	ACTIVE	SOIC	D	8	75	Green (RoHS & no Sb/Br)	CU NIPDAU	Level-1-260C-UNLIM
THS3112IDDA	ACTIVE	SO Power PAD	DDA	8	75	Green (RoHS & no Sb/Br)	CU SN	Level-1-260C-UNLIM
THS3112IDDAG3	ACTIVE	SO Power PAD	DDA	8	75	Green (RoHS & no Sb/Br)	CU SN	Level-1-260C-UNLIM
THS3112IDDAR	ACTIVE	SO Power PAD	DDA	8	2500	Green (RoHS & no Sb/Br)	CU SN	Level-1-260C-UNLIM
THS3112IDDARG3	ACTIVE	SO Power PAD	DDA	8	2500	Green (RoHS & no Sb/Br)	CU SN	Level-1-260C-UNLIM
THS3112IDG4	ACTIVE	SOIC	D	8	75	Green (RoHS & no Sb/Br)	CU NIPDAU	Level-1-260C-UNLIM
THS3112IDR	ACTIVE	SOIC	D	8	2500	Green (RoHS & no Sb/Br)	CU NIPDAU	Level-1-260C-UNLIM
THS3112IDRG4	ACTIVE	SOIC	D	8	2500	Green (RoHS & no Sb/Br)	CU NIPDAU	Level-1-260C-UNLIM
THS3115CD	ACTIVE	SOIC	D	14	50	Green (RoHS & no Sb/Br)	CU NIPDAU	Level-1-260C-UNLIM
THS3115CDG4	ACTIVE	SOIC	D	14	50	Green (RoHS & no Sb/Br)	CU NIPDAU	Level-1-260C-UNLIM
THS3115CDR	ACTIVE	SOIC	D	14	2500	Green (RoHS & no Sb/Br)	CU NIPDAU	Level-1-260C-UNLIM
THS3115CDRG4	ACTIVE	SOIC	D	14	2500	Green (RoHS & no Sb/Br)	CU NIPDAU	Level-1-260C-UNLIM
THS3115CPWP	ACTIVE	HTSSOP	PWP	14	90	Green (RoHS & no Sb/Br)	CU NIPDAU	Level-2-260C-1 YEAR
THS3115CPWPG4	ACTIVE	HTSSOP	PWP	14	90	Green (RoHS & no Sb/Br)	CU NIPDAU	Level-2-260C-1 YEAR

Orderable Device	Status ⁽¹⁾	Package Type	Package Drawing	Pins	Package Qty	Eco Plan ⁽²⁾	Lead/Ball Finish	MSL Peak Temp ⁽³⁾
						no Sb/Br)		
THS3115CPWPR	ACTIVE	HTSSOP	PWP	14	2000	Green (RoHS & no Sb/Br)	CU NIPDAU	Level-2-260C-1 YEAR
THS3115CPWPRG4	ACTIVE	HTSSOP	PWP	14	2000	Green (RoHS & no Sb/Br)	CU NIPDAU	Level-2-260C-1 YEAR
THS3115ID	ACTIVE	SOIC	D	14	75	Green (RoHS & no Sb/Br)	CU NIPDAU	Level-1-260C-UNLIM
THS3115IDG4	ACTIVE	SOIC	D	14	75	Green (RoHS & no Sb/Br)	CU NIPDAU	Level-1-260C-UNLIM
THS3115IDR	ACTIVE	SOIC	D	14	2500	Green (RoHS & no Sb/Br)	CU NIPDAU	Level-1-260C-UNLIM
THS3115IDRG4	ACTIVE	SOIC	D	14	2500	Green (RoHS & no Sb/Br)	CU NIPDAU	Level-1-260C-UNLIM
THS3115IPWP	ACTIVE	HTSSOP	PWP	14	90	Green (RoHS & no Sb/Br)	CU NIPDAU	Level-2-260C-1 YEAR
THS3115IPWPG4	ACTIVE	HTSSOP	PWP	14	90	Green (RoHS & no Sb/Br)	CU NIPDAU	Level-2-260C-1 YEAR
THS3115IPWPR	ACTIVE	HTSSOP	PWP	14	2000	Green (RoHS & no Sb/Br)	CU NIPDAU	Level-2-260C-1 YEAR
THS3115IPWPRG4	ACTIVE	HTSSOP	PWP	14	2000	Green (RoHS & no Sb/Br)	CU NIPDAU	Level-2-260C-1 YEAR

⁽¹⁾ The marketing status values are defined as follows:

ACTIVE: Product device recommended for new designs.

LIFEBUY: TI has announced that the device will be discontinued, and a lifetime-buy period is in effect.

NRND: Not recommended for new designs. Device is in production to support existing customers, but TI does not recommend using this part in a new design.

PREVIEW: Device has been announced but is not in production. Samples may or may not be available.

OBSOLETE: TI has discontinued the production of the device.

⁽²⁾ Eco Plan - The planned eco-friendly classification: Pb-Free (RoHS), Pb-Free (RoHS Exempt), or Green (RoHS & no Sb/Br) - please check <http://www.ti.com/productcontent> for the latest availability information and additional product content details.

TBD: The Pb-Free/Green conversion plan has not been defined.

Pb-Free (RoHS): TI's terms "Lead-Free" or "Pb-Free" mean semiconductor products that are compatible with the current RoHS requirements for all 6 substances, including the requirement that lead not exceed 0.1% by weight in homogeneous materials. Where designed to be soldered at high temperatures, TI Pb-Free products are suitable for use in specified lead-free processes.

Pb-Free (RoHS Exempt): This component has a RoHS exemption for either 1) lead-based flip-chip solder bumps used between the die and package, or 2) lead-based die adhesive used between the die and leadframe. The component is otherwise considered Pb-Free (RoHS compatible) as defined above.

Green (RoHS & no Sb/Br): TI defines "Green" to mean Pb-Free (RoHS compatible), and free of Bromine (Br) and Antimony (Sb) based flame retardants (Br or Sb do not exceed 0.1% by weight in homogeneous material)

⁽³⁾ MSL, Peak Temp. -- The Moisture Sensitivity Level rating according to the JEDEC industry standard classifications, and peak solder temperature.

Important Information and Disclaimer:The information provided on this page represents TI's knowledge and belief as of the date that it is provided. TI bases its knowledge and belief on information provided by third parties, and makes no representation or warranty as to the accuracy of such information. Efforts are underway to better integrate information from third parties. TI has taken and continues to take reasonable steps to provide representative and accurate information but may not have conducted destructive testing or chemical analysis on incoming materials and chemicals. TI and TI suppliers consider certain information to be proprietary, and thus CAS numbers and other limited information may not be available for release.

In no event shall TI's liability arising out of such information exceed the total purchase price of the TI part(s) at issue in this document sold by TI to Customer on an annual basis.

PWP (R-PDSO-G**) 20 PIN SHOWN

PowerPAD™ PLASTIC SMALL-OUTLINE PACKAGE

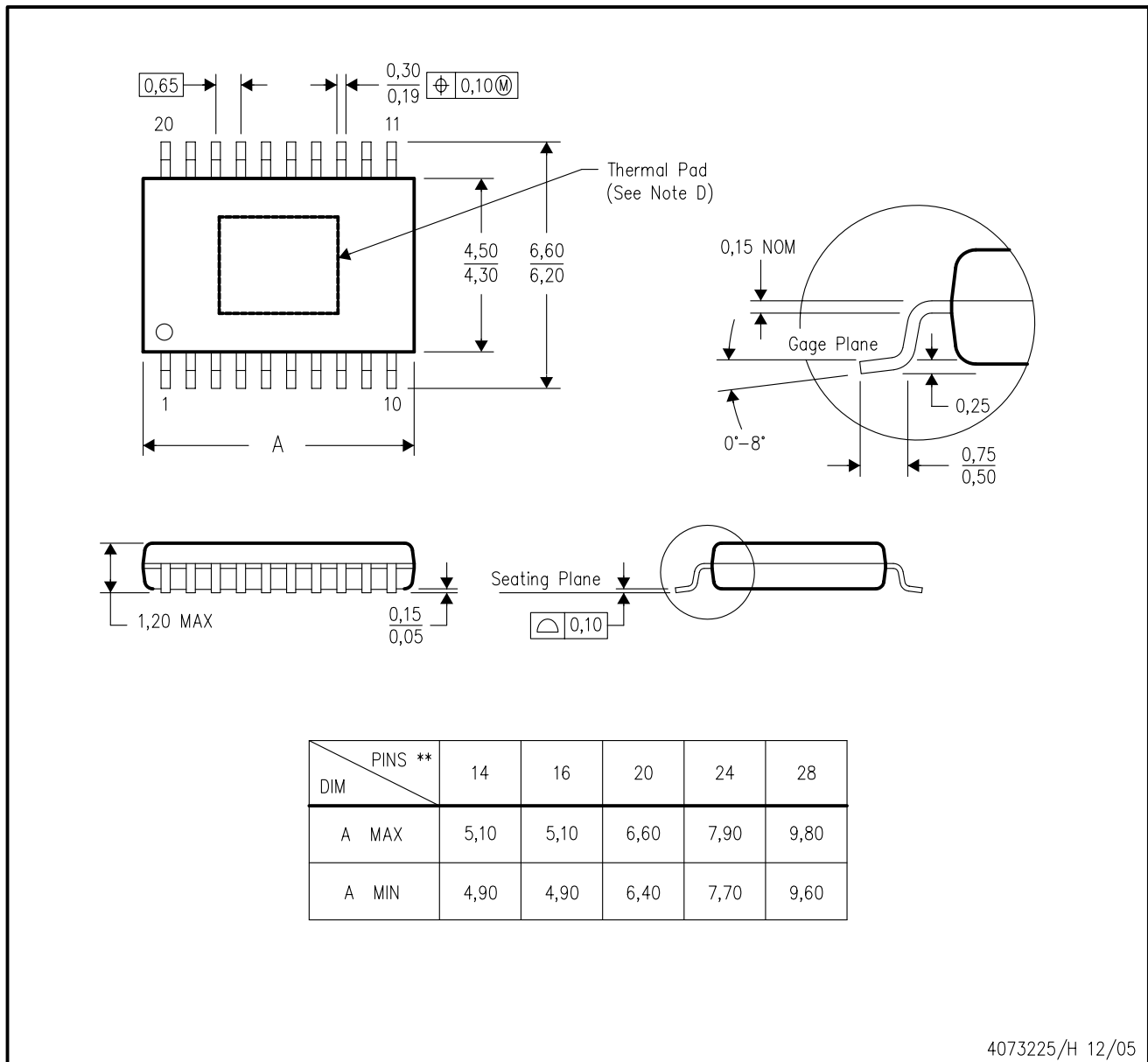

- NOTES:
- A. All linear dimensions are in millimeters.
 - B. This drawing is subject to change without notice.
 - C. Body dimensions do not include mold flash or protrusions. Mold flash and protrusion shall not exceed 0.15 per side.
 - D. This package is designed to be soldered to a thermal pad on the board. Refer to Technical Brief, PowerPad Thermally Enhanced Package, Texas Instruments Literature No. SLMA002 for information regarding recommended board layout. This document is available at www.ti.com <<http://www.ti.com>>.
 - E. Falls within JEDEC MO-153

PowerPAD is a trademark of Texas Instruments.

THERMAL INFORMATION

This PowerPAD™ package incorporates an exposed thermal pad that is designed to be attached directly to an external heatsink. When the thermal pad is soldered directly to the printed circuit board (PCB), the PCB can be used as a heatsink. In addition, through the use of thermal vias, the thermal pad can be attached directly to a ground plane or special heatsink structure designed into the PCB. This design optimizes the heat transfer from the integrated circuit (IC).

For additional information on the PowerPAD package and how to take advantage of its heat dissipating abilities, refer to Technical Brief, PowerPAD Thermally Enhanced Package, Texas Instruments Literature No. SLMA002 and Application Brief, PowerPAD Made Easy, Texas Instruments Literature No. SLMA004. Both documents are available at www.ti.com.

The exposed thermal pad dimensions for this package are shown in the following illustration.

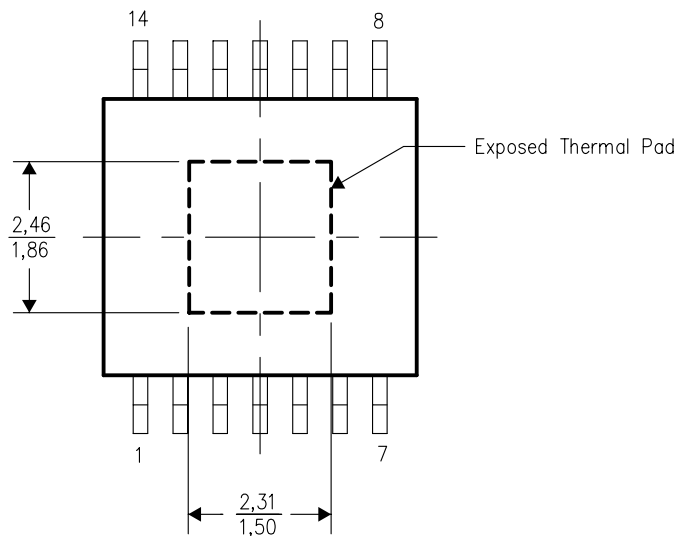

Top View

NOTE: All linear dimensions are in millimeters

Exposed Thermal Pad Dimensions

PWP (R-PDSO-G14) PowerPAD™

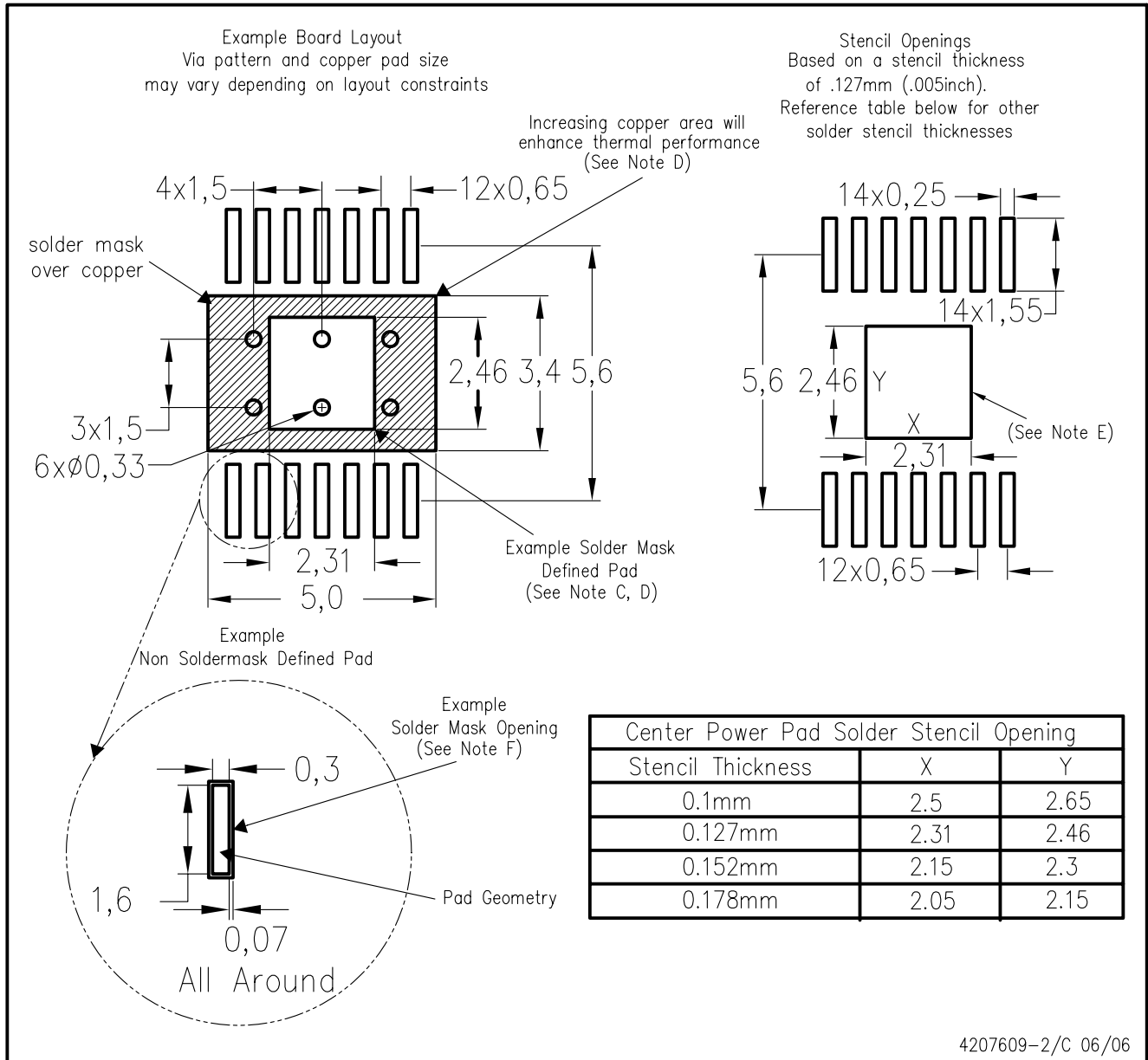

4207609-2/C 06/06

- NOTES:
- All linear dimensions are in millimeters.
 - This drawing is subject to change without notice.
 - Customers should place a note on the circuit board fabrication drawing not to alter the center solder mask defined pad.
 - This package is designed to be soldered to a thermal pad on the board. Refer to Technical Brief, PowerPad Thermally Enhanced Package, Texas Instruments Literature No. SLMA002, SLMA004, and also the Product Data Sheets for specific thermal information, via requirements, and recommended board layout. These documents are available at www.ti.com <<http://www.ti.com>>. Publication IPC-7351 is recommended for alternate designs.
 - Laser cutting apertures with trapezoidal walls and also rounding corners will offer better paste release. Customers should contact their board assembly site for stencil design recommendations. Example stencil design based on a 50% volumetric metal load solder paste. Refer to IPC-7525 for other stencil recommendations.
 - Customers should contact their board fabrication site for solder mask tolerances between and around signal pads.

PowerPAD is a trademark of Texas Instruments.

DDA (R-PDSO-G8)

PowerPAD™ PLASTIC SMALL-OUTLINE PACKAGE

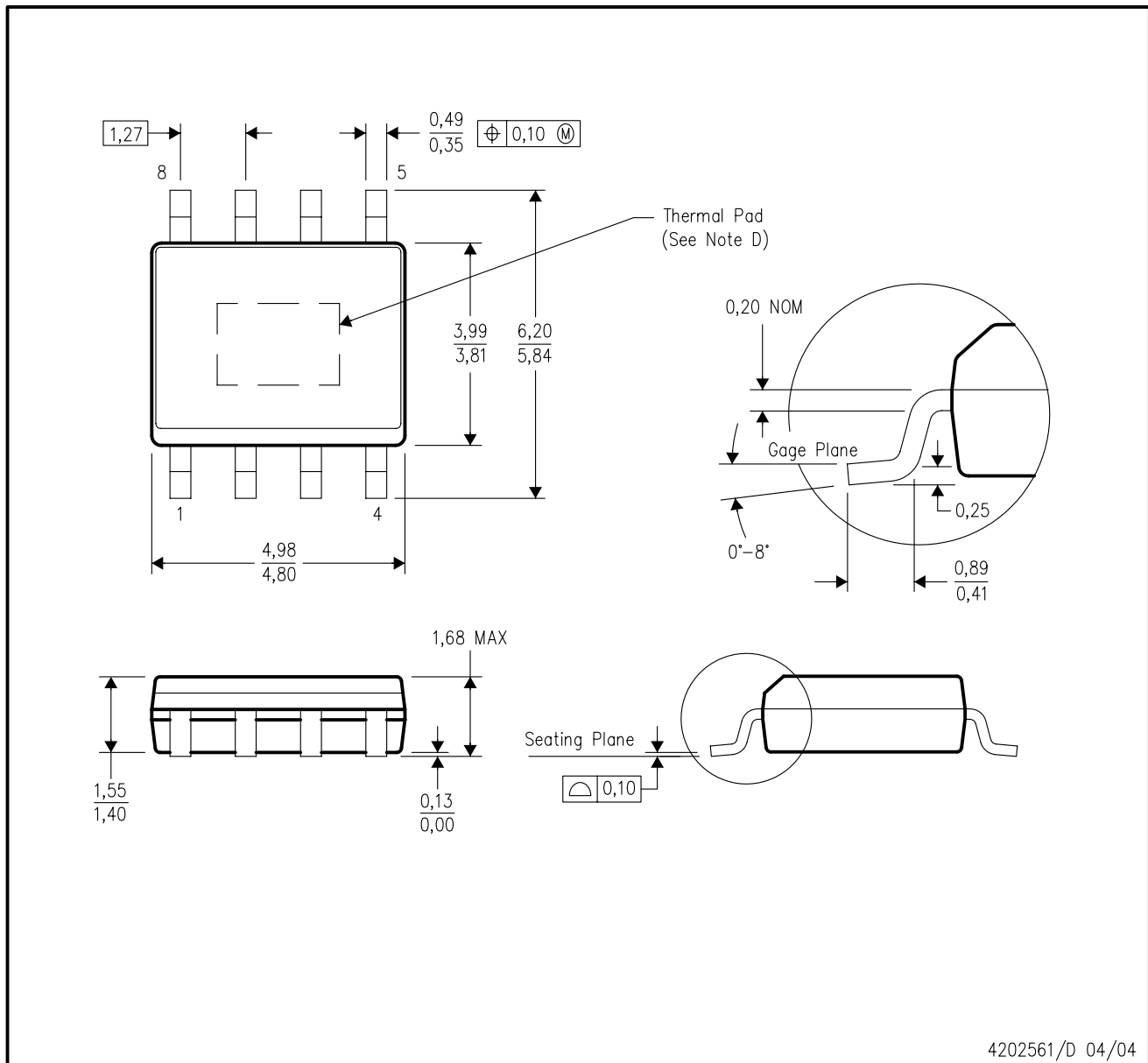

- NOTES:
- All linear dimensions are in millimeters.
 - This drawing is subject to change without notice.
 - Body dimensions do not include mold flash or protrusion not to exceed 0,15.
 - This package is designed to be soldered to a thermal pad on the board. Refer to Technical Brief, PowerPad Thermally Enhanced Package, Texas Instruments Literature No. SLMA002 for information regarding recommended board layout. This document is available at www.ti.com <<http://www.ti.com>>.

PowerPAD is a trademark of Texas Instruments.

THERMAL INFORMATION

This PowerPAD™ package incorporates an exposed thermal pad that is designed to be attached directly to an external heatsink. When the thermal pad is soldered directly to the printed circuit board (PCB), the PCB can be used as a heatsink. In addition, through the use of thermal vias, the thermal pad can be attached directly to a ground or power plane (whichever is applicable), or alternatively, a special heatsink structure designed into the PCB. This design optimizes the heat transfer from the integrated circuit (IC).

For additional information on the PowerPAD package and how to take advantage of its heat dissipating abilities, refer to Technical Brief, PowerPAD Thermally Enhanced Package, Texas Instruments Literature No. SLMA002 and Application Brief, PowerPAD Made Easy, Texas Instruments Literature No. SLMA004. Both documents are available at www.ti.com.

The exposed thermal pad dimensions for this package are shown in the following illustration.

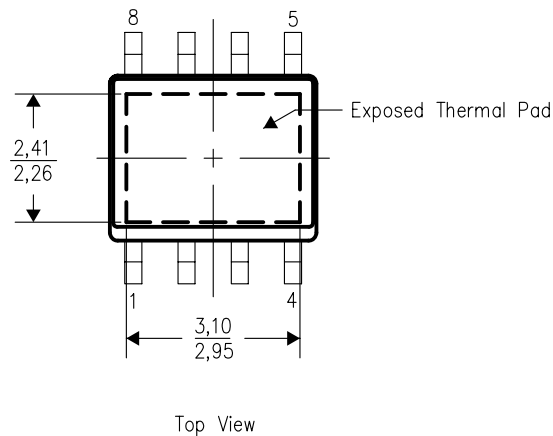

NOTE: All linear dimensions are in millimeters

Exposed Thermal Pad Dimensions

D (R-PDSO-G14)

PLASTIC SMALL-OUTLINE PACKAGE

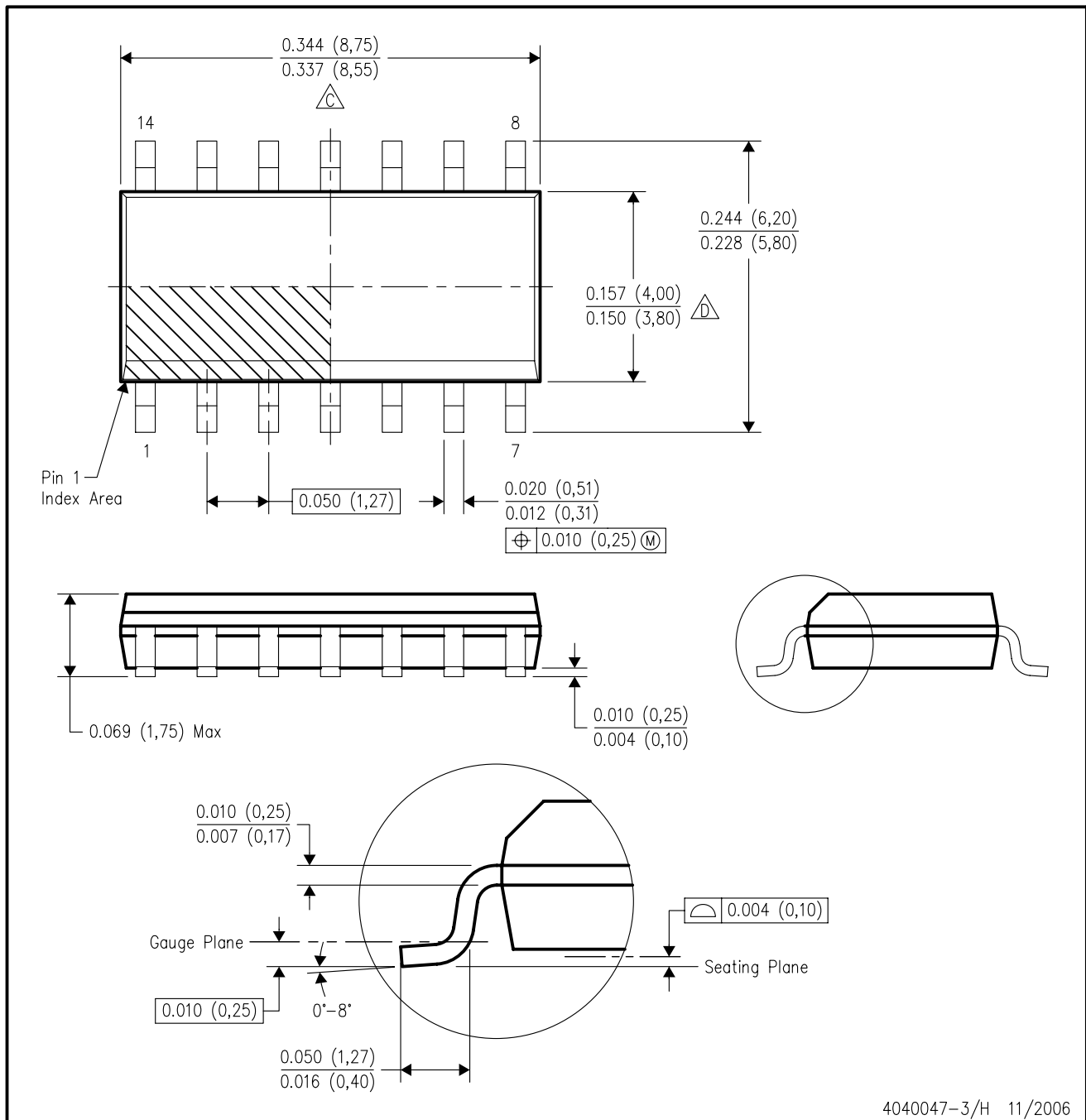

- NOTES:
- A. All linear dimensions are in inches (millimeters).
 - B. This drawing is subject to change without notice.
 - C. Body length does not include mold flash, protrusions, or gate burrs. Mold flash, protrusions, or gate burrs shall not exceed .006 (0,15) per end.
 - D. Body width does not include interlead flash. Interlead flash shall not exceed .017 (0,43) per side.
 - E. Reference JEDEC MS-012 variation AB.

D (R-PDSO-G8)

PLASTIC SMALL-OUTLINE PACKAGE

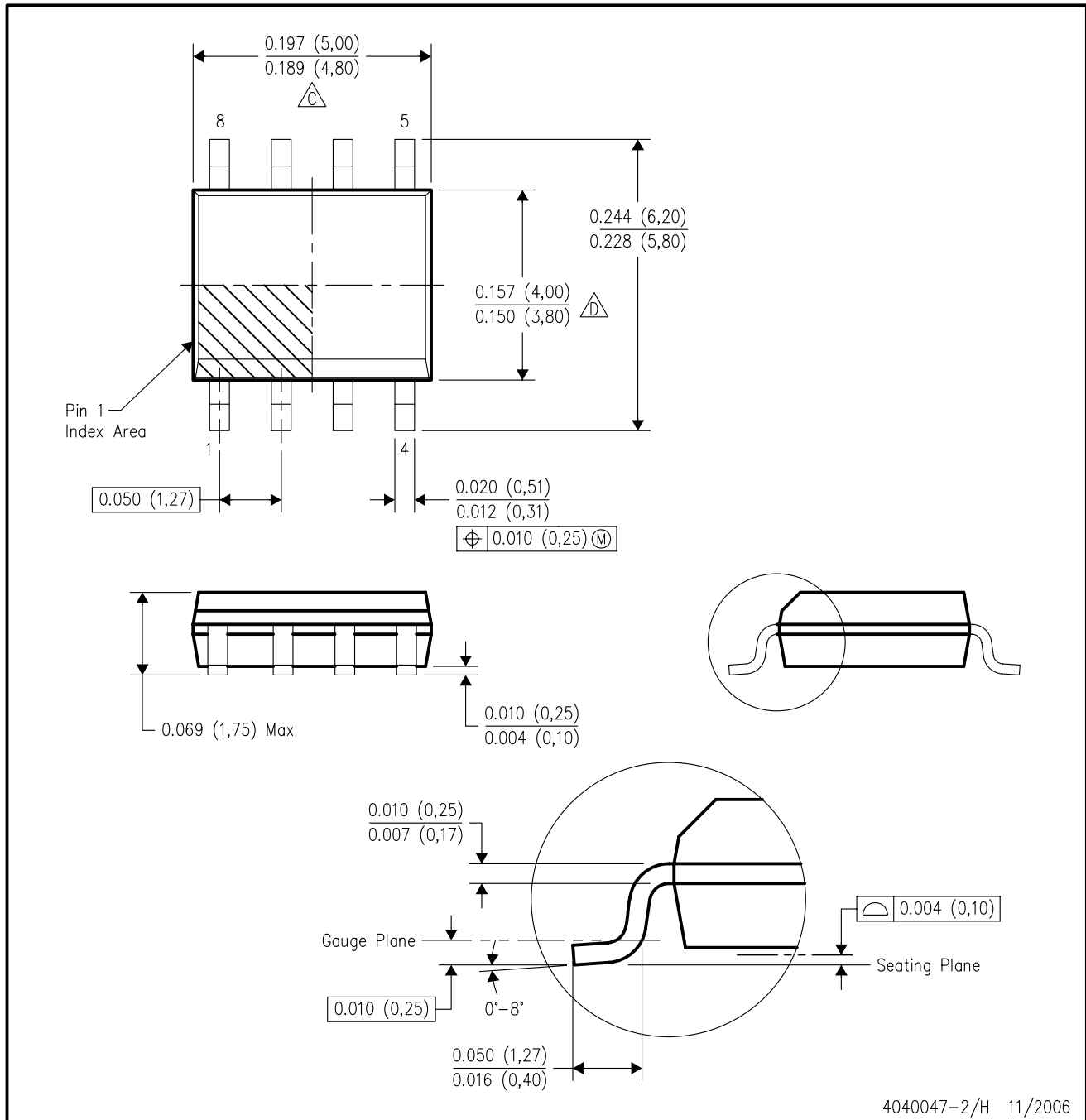

- NOTES:
- A. All linear dimensions are in inches (millimeters).
 - B. This drawing is subject to change without notice.
 - $\triangle C$ Body length does not include mold flash, protrusions, or gate burrs. Mold flash, protrusions, or gate burrs shall not exceed .006 (0,15) per end.
 - $\triangle D$ Body width does not include interlead flash. Interlead flash shall not exceed .017 (0,43) per side.
 - E. Reference JEDEC MS-012 variation AA.

IMPORTANT NOTICE

Texas Instruments Incorporated and its subsidiaries (TI) reserve the right to make corrections, modifications, enhancements, improvements, and other changes to its products and services at any time and to discontinue any product or service without notice. Customers should obtain the latest relevant information before placing orders and should verify that such information is current and complete. All products are sold subject to TI's terms and conditions of sale supplied at the time of order acknowledgment.

TI warrants performance of its hardware products to the specifications applicable at the time of sale in accordance with TI's standard warranty. Testing and other quality control techniques are used to the extent TI deems necessary to support this warranty. Except where mandated by government requirements, testing of all parameters of each product is not necessarily performed.

TI assumes no liability for applications assistance or customer product design. Customers are responsible for their products and applications using TI components. To minimize the risks associated with customer products and applications, customers should provide adequate design and operating safeguards.

TI does not warrant or represent that any license, either express or implied, is granted under any TI patent right, copyright, mask work right, or other TI intellectual property right relating to any combination, machine, or process in which TI products or services are used. Information published by TI regarding third-party products or services does not constitute a license from TI to use such products or services or a warranty or endorsement thereof. Use of such information may require a license from a third party under the patents or other intellectual property of the third party, or a license from TI under the patents or other intellectual property of TI.

Reproduction of information in TI data books or data sheets is permissible only if reproduction is without alteration and is accompanied by all associated warranties, conditions, limitations, and notices. Reproduction of this information with alteration is an unfair and deceptive business practice. TI is not responsible or liable for such altered documentation.

Resale of TI products or services with statements different from or beyond the parameters stated by TI for that product or service voids all express and any implied warranties for the associated TI product or service and is an unfair and deceptive business practice. TI is not responsible or liable for any such statements.

Following are URLs where you can obtain information on other Texas Instruments products and application solutions:

Products

Amplifiers	amplifier.ti.com
Data Converters	dataconverter.ti.com
DSP	dsp.ti.com
Interface	interface.ti.com
Logic	logic.ti.com
Power Mgmt	power.ti.com
Microcontrollers	microcontroller.ti.com
Low Power Wireless	www.ti.com/lpw

Applications

Audio	www.ti.com/audio
Automotive	www.ti.com/automotive
Broadband	www.ti.com/broadband
Digital Control	www.ti.com/digitalcontrol
Military	www.ti.com/military
Optical Networking	www.ti.com/opticalnetwork
Security	www.ti.com/security
Telephony	www.ti.com/telephony
Video & Imaging	www.ti.com/video
Wireless	www.ti.com/wireless

Mailing Address: Texas Instruments
Post Office Box 655303 Dallas, Texas 75265