

02P-10P

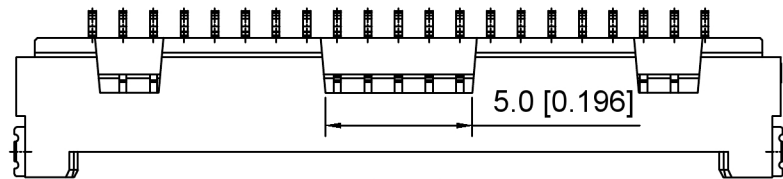

11P-20P
(25P/30P:6.0±0.1)

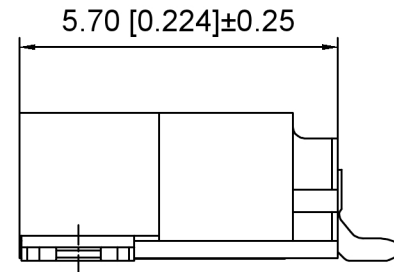
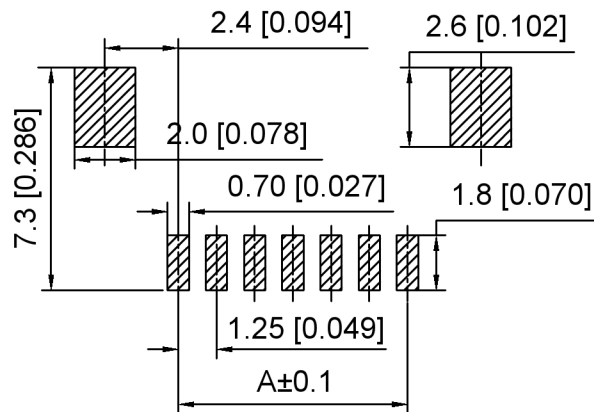
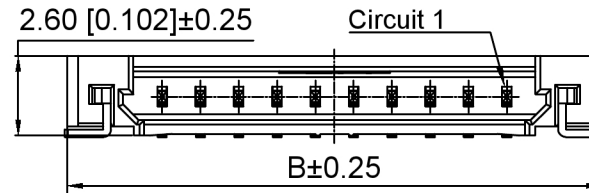

PCB Layout

Specifications:

规格:

Voltage rating: 150V AC/DC

额定电压: 150V AC/DC

Current rating: 1A AC/DC

额定电流: 1A AC/DC

Withstanding voltage: 500V AC/minute

耐受电压: 500V AC/分钟

Temperature range: -25°C-+85°C

温度范围: -25°C-+85°C

Insulation resistance: 500MΩ min

绝缘电阻: 500MΩ Min

Contact resistance: 30mΩ Max

接触电阻: 30mΩ Max

X9862 W R S -XX -6T SN

① ② ③ ④ ⑤ ⑥ ⑦

1. Series No
2. Category: W-Wafer
3. Welding Board Angle: R-Straight 90°
4. Welding Way: S-SMT
5. Row No. Pin No: XX-02P-30P
6. Material: 6T-PA6T UL94V-0 Beige
7. Plating: SN-Bright Tin Plating

Poles	DIM.(mm)	
	A	B
02	1.25	7.45
03	2.50	8.70
04	3.75	9.95
05	5.00	11.20
06	6.25	12.45
07	7.50	13.70
08	8.75	14.95
09	10.00	16.20
10	11.25	17.45
11	12.50	18.70
12	13.74	19.95
13	15.00	21.20
14	16.25	22.45
15	17.50	23.70
20	23.75	29.95
25	30.00	36.20
30	36.25	42.45

X9862WRS-XX-6TSN	PA6T	Brass	X9862H
PART NO	Material	Material(Pin)	SUITable XKB Housing

DSND	SCALE: N/A	MODEL TYPE: 1.25mm Crimp Style Connector
DWN	VIEW:	PART NO.: X9862WRS-XX-6TSN
CHKD	UNIT: mm/in	DWG NO.: X-X9862WRS-XX-6TSN
APPD	SIZE: A4	



XKB INDUSTRIAL PRECISION CO., LIMITED

WEIGHT	SHEET	REVISION
	1/1	A0

广东星坤科技股份有限公司

MARK	DESCRIPTION	DATE	REVISED	APPROVED
Δx				
Δx				
Δx				

文件工程章

REVISIONS	UNSPECIFIED TOLERANCES
ANGLAR ±5°	
L ≤ 4 ±0.2	
4 < L ≤ 16 ±0.3	
16 < L ≤ 63 ±0.4	
L > 63 ±0.5	

www.helloxkb.com www.helloxkb.cn www.xk-dg.cn

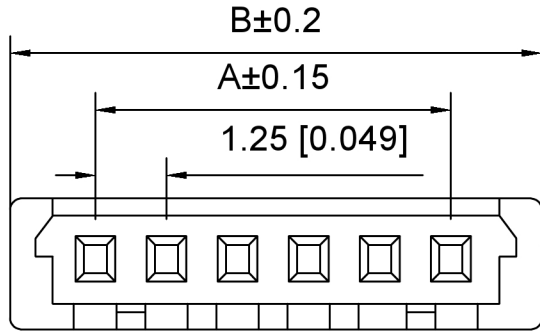
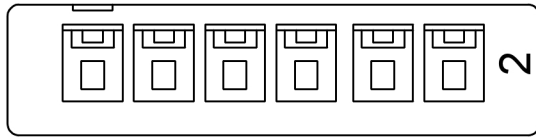

03P~30P

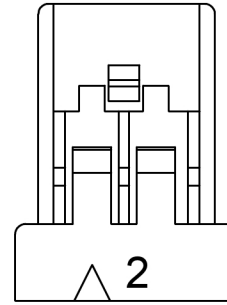

02P

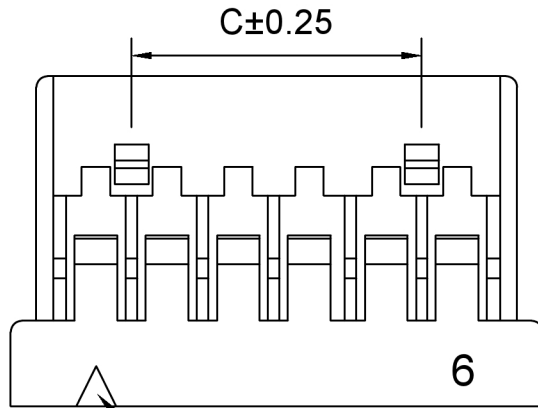
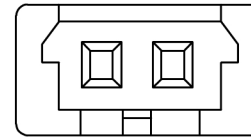

Circuit 1

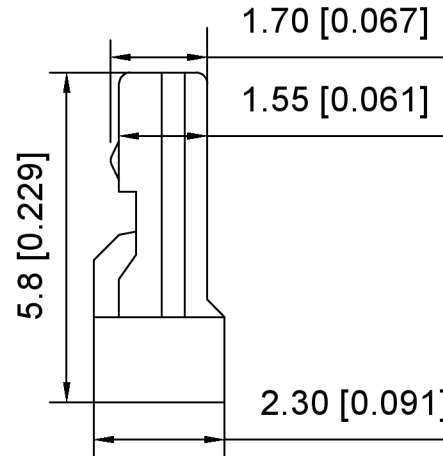

Specifications:

规格:

Voltage rating:150V AC/DC

额定电压: 150V AC/DC

Current rating:1A AC/DC

额定电流: 1A AC/DC

Withstanding voltage:500V AC/minute

耐受电压: 500V AC/分钟

Temperature range:-25°C-+85°C

温度范围: -25°C-+85°C

Insulation resistance:500MΩ min

绝缘电阻: 500MΩ Min

Contact resistance:30mΩ Max

接触电阻: 30mΩ Max

X9862 H -XX - N0

① ② ③ ④

1.Series No

2.Category:H-HSG

3.Row No.Pin No:XX-02P-30P

4.Material:N0-Nylon66

UL 94V-0 Grey

Poles	DIM		
	A	B	C
02	1.25	4.35	/
03	2.50	5.60	1.25
04	3.75	6.85	2.50
05	5.00	8.10	3.75
06	6.25	9.35	5.00
07	7.50	10.60	6.25
08	8.75	11.85	7.50
09	10.00	13.10	8.75
10	11.25	14.35	10.00
11	12.50	15.60	11.25
12	13.75	16.85	12.50
13	15.00	18.10	13.75
14	16.25	19.35	15.00
15	17.50	20.60	16.25
20	23.75	26.85	22.50
25	30.00	33.10	28.75
30	36.25	39.35	35.00

X9862H-XX-N0	Nylon 66	X9862W	X9862T
PART NO	Material	Suitable XKB Wafer	Suitable XKB Terminal

DSND	SCALE: N/A	MODEL TYPE: 1.25mm Crimp Style Connector
DWN	VIEW:	PART NO.: X9862H-XX-N0
CHKD	UNIT: mm/in	DWG NO.: X-X9862H-XX-N0
APPD	SIZE: A4	



XKB INDUSTRIAL PRECISION CO.,LIMITED

WEIGHT	SHEET	REVISION
	1/1	A0

广东星坤科技股份有限公司

Δx	日期
Δx	日期
Δx	日期
MARK	DESCRIPTION

文件工程章

REVISIONS	DATE	REVISED	APPROVED	UNSPECIFIED TOLERANCES
ANGLAR				±5°
L≤ 4				±0.2
4<L≤ 16				±0.3
16<L≤ 63				±0.4
L> 63				±0.5

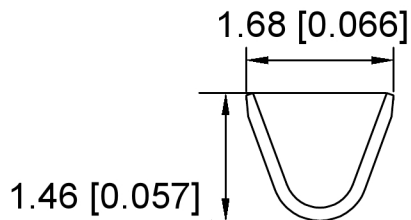
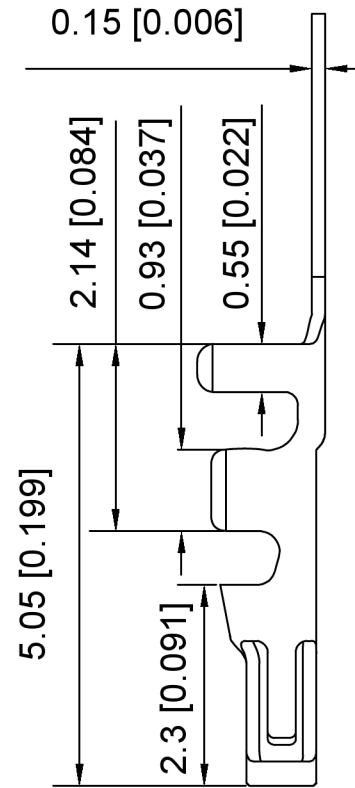
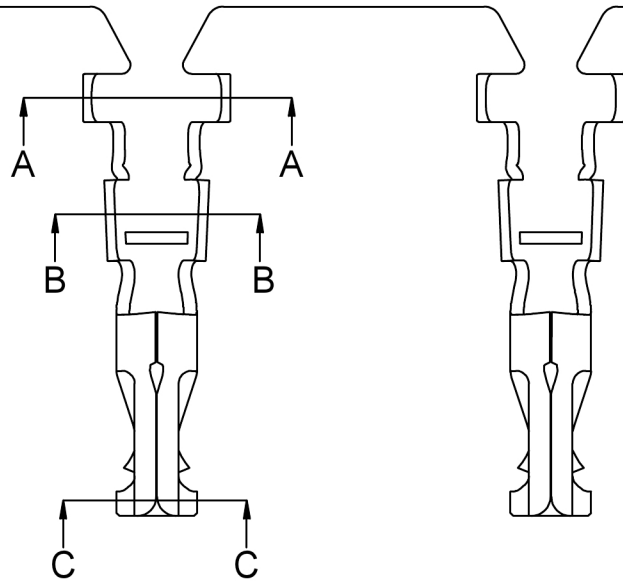
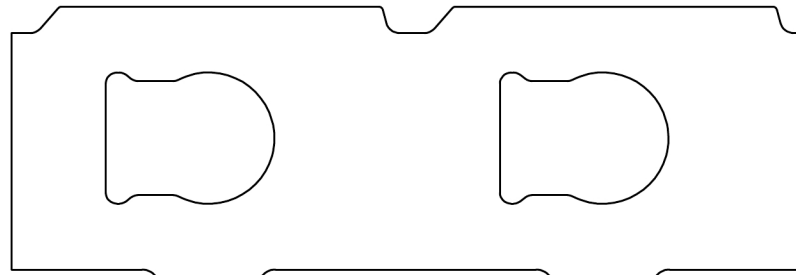

Section A-A

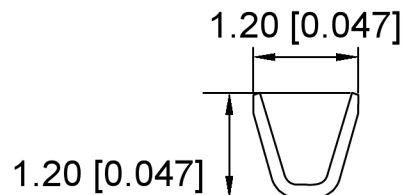

Section B-B

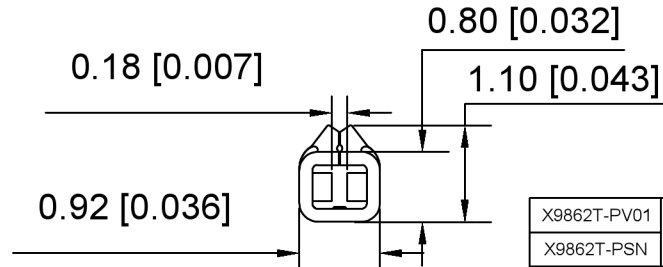

Section C-C

Specifications:

规格:

Voltage rating: 150V AC/DC
 额定电压: 150V AC/DC
 Current rating: 1A AC/DC
 额定电流: 1A AC/DC
 Withstanding voltage: 500V AC/minute
 耐受电压: 500V AC/分钟
 Temperature range: -25°C +85°C
 温度范围: -25°C +85°C
 Insulation resistance: 500MΩ min
 绝缘电阻: 500MΩ Min
 Contact resistance: 30mΩ Max
 接触电阻: 30mΩ Max

X9862 T - P V01

- 1
- 2
- 3
- 4

1. Series No
2. Category: T-Terminal
3. Material: P-Phosphor Bronze
4. Plating: V01-Gold Flash
SN-Tin Plated

X9862T-PV01	PHOSPHOR BRONZE	AWG#28-32 O.D.0.9mm (Max)	Gold Flash	X9862H
X9862T-PSN			Tin	
PART NO	Material	Wire Range	Plating	Suitable XKB Housing

DSND	SCALE: N/A	MODEL TYPE: 1.25mm Crimp Style Connector
DWN	VIEW:	PART NO.: X9862T-PV01
CHKD	UNIT: mm/in	DWG NO.: X9862T-PV01
APPD	SIZE: A4	WEIGHT
XKB INDUSTRIAL PRECISION CO., LIMITED		SHEET
		1/1
		REVISION
		A0

广东星坤科技股份有限公司

MARK	DESCRIPTION	DATE	REVISED	APPROVED	UNSPECIFIED TOLERANCES
ΔX					ANGULAR ±5°
ΔX					L ≤ 4 ±0.2
ΔX					4 < L ≤ 16 ±0.3
					16 < L ≤ 63 ±0.4
					L > 63 ±0.5



文件工程章