

# 1200 V Gen 4 Power Silicon Carbide Schottky Diode, 5 A

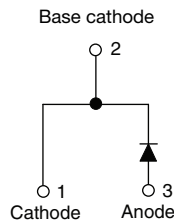

TO-220AC 2L



## FEATURES

- Positive  $V_F$  temperature coefficient for easy paralleling
- Virtually no recovery tail and no switching losses
- Temperature invariant switching behavior
- 175 °C maximum operating junction temperature
- AEC Q101 qualified, meets class 2 whisker test
- Solder bath temperature 275 °C maximum, 10 s per JESD 22-B106
- Material categorization: for definitions of compliance please see [www.vishay.com/doc?99912](http://www.vishay.com/doc?99912)

**RoHS**  
 COMPLIANT  
 HALOGEN  
**FREE**

## LINKS TO ADDITIONAL RESOURCES



3D Models

PRIMARY CHARACTERISTICS	
$I_F$	5 A
$V_R$	1200 V
$V_F$ at $I_F$ at 25 °C, typ.	1.35 V
$T_J$ max.	175 °C
$I_R$ at $V_R$ at 175 °C	76 $\mu$ A typ.
$Q_C$ ( $V_R = 800$ V)	27 nC
Package	TO-220AC 2L
Circuit configuration	Single

## DESCRIPTION / APPLICATIONS

Wide band gap SiC based 1200 V Schottky diode, designed for high performance and ruggedness.

Optimized for extreme high-speed hard switching across a wide temperature range. This SiC diode is ideal for demanding applications such as high efficiency PFC diodes and ultra-high frequency output rectifiers in AC/DC and DC/DC converters.

## MECHANICAL DATA

**Case:** TO-220AC 2L

Molding compound meets UL 94 V-0 flammability rating Base P/NHM3 - halogen-free, RoHS-compliant, and AEC-Q101 qualified

**Terminals:** matte tin plated leads, solderable per J-STD-002 and JESD 22-B102

**Mounting torque:** 10 in-lbs maximum

MAXIMUM RATINGS ( $T_A = 25$ °C unless otherwise specified)				
PARAMETER	SYMBOL	TEST CONDITIONS	VALUES	UNITS
Peak repetitive reverse voltage	$V_{RRM}$		1200	V
Continuous forward current	$I_F$ (1)	$T_C = 158$ °C (DC)	5	A
		$T_C = 153$ °C (DC)	5	A
DC blocking voltage	$V_{DC}$		1200	V
Repetitive peak forward current	$I_{FRM}$	$T_C = 25$ °C, $f = 50$ Hz, square wave, DC = 25 %	26	A
Non-repetitive peak forward surge current	$I_{FSM}$	$T_C = 25$ °C, $t_p = 10$ ms, half sine wave	40	A
		$T_C = 110$ °C, $t_p = 10$ ms, half sine wave	30	
Power dissipation	$P_{tot}$ (1)	$T_C = 25$ °C	86	W
		$T_C = 110$ °C	37	
	$P_{tot}$ (2)	$T_C = 25$ °C	62.5	
		$T_C = 110$ °C	27	
$I^2t$ value	$\int i^2 dt$	$T_C = 25$ °C	8	A <sup>2</sup> s
		$T_C = 110$ °C	4.5	
Operating junction and storage temperatures	$T_J$ (3), $T_{Stg}$		-55 to +175	°C

### Notes

- (1) Based on typical  $R_{th}$
- (2) Based on maximum  $R_{th}$
- (3) The heat generated must be less than the thermal conductivity from junction-to-ambient:  $dP_D/dT_J < 1/R_{\theta JA}$



ELECTRICAL SPECIFICATIONS ( $T_J = 25\text{ }^\circ\text{C}$ unless otherwise specified)						
PARAMETER	SYMBOL	TEST CONDITIONS	MIN.	TYP.	MAX.	UNITS
Forward voltage	$V_F$	$I_F = 5\text{ A}$	-	1.35	1.6	V
		$I_F = 5\text{ A}, T_J = 150\text{ }^\circ\text{C}$	-	1.74	2	
		$I_F = 5\text{ A}, T_J = 175\text{ }^\circ\text{C}$	-	1.87	-	
Reverse leakage current	$I_R$	$V_R = V_R\text{ rated}$	-	2.4	80	$\mu\text{A}$
		$V_R = V_R\text{ rated}, T_J = 150\text{ }^\circ\text{C}$	-	36	190	
		$V_R = V_R\text{ rated}, T_J = 175\text{ }^\circ\text{C}$	-	76	-	
Total capacitance	C	$V_R = 1\text{ V}, f = 1\text{ MHz}$	-	300	-	pF
		$V_R = 800\text{ V}, f = 1\text{ MHz}$	-	19	-	
Total capacitive charge	$Q_C$	$V_R = 800\text{ V}, f = 1\text{ MHz}$	-	27	-	nC

THERMAL AND MECHANICAL SPECIFICATIONS ( $T_A = 25\text{ }^\circ\text{C}$ unless otherwise specified)						
PARAMETER	SYMBOL	TEST CONDITIONS	MIN.	TYP.	MAX.	UNITS
Thermal resistance, junction-to-case	$R_{thJC}$		-	1.75	2.4	$^\circ\text{C/W}$
Marking device			4C05ET12T			

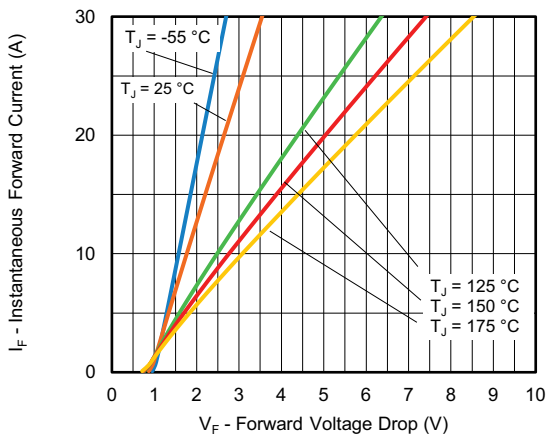

Fig. 1 - Typical Forward Voltage Drop Characteristics

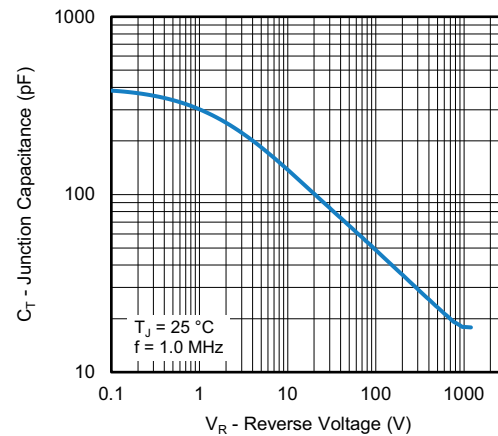

Fig. 3 - Typical Junction Capacitance vs. Reverse Voltage

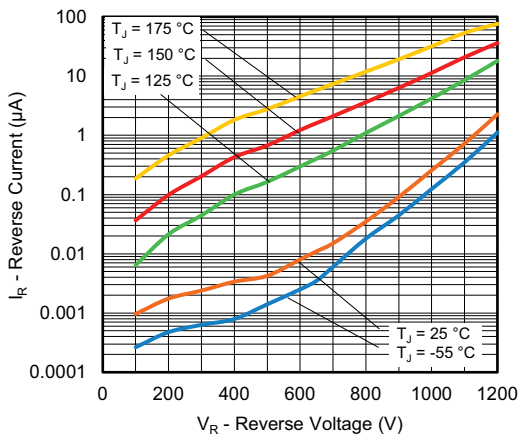

Fig. 2 - Typical Values of Reverse Current vs. Reverse Voltage

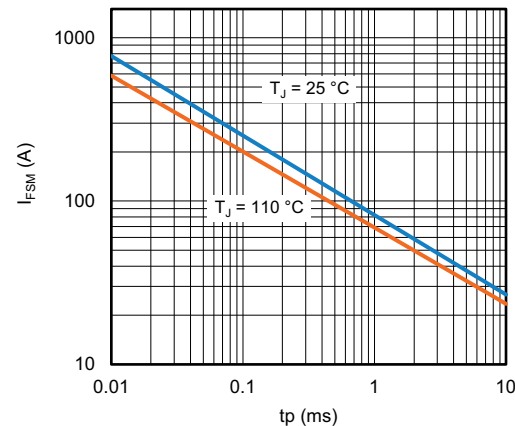

Fig. 4 - Non-Repetitive Peak Forward Surge Current vs. Pulse Duration (Square Wave)

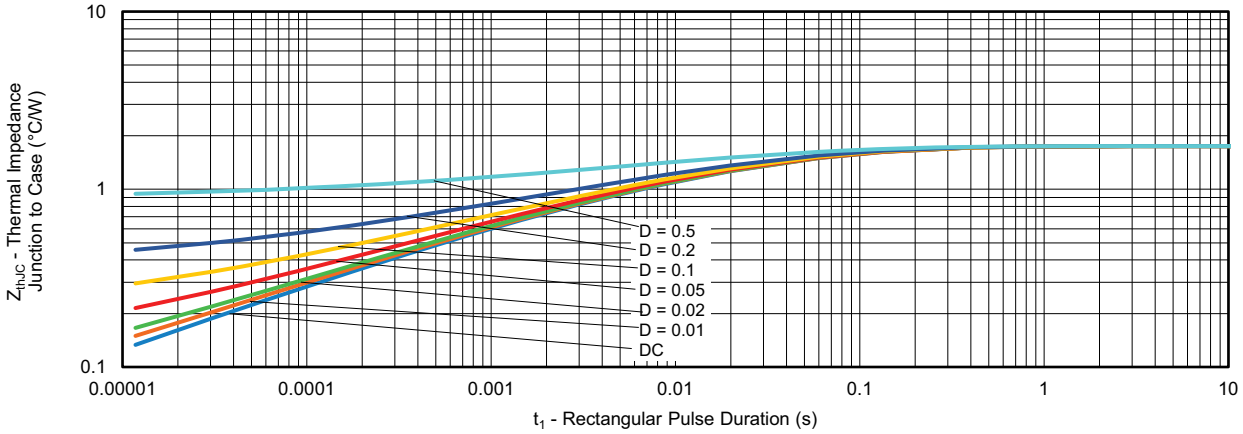

Fig. 5 - Typical Thermal Impedance  $Z_{thJC}$  Characteristics

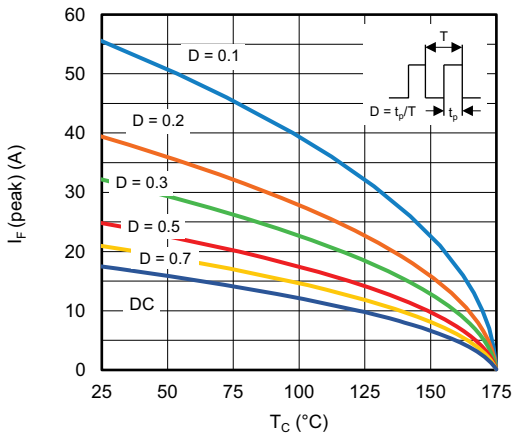

Fig. 6 - Peak Forward Current vs. Maximum Allowable Case Temperature

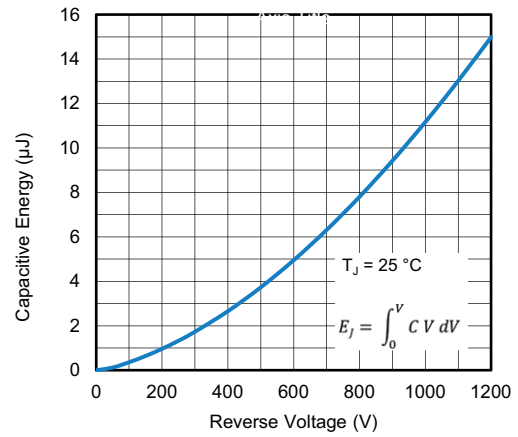

Fig. 8 - Typical Capacitive Energy vs. Reverse Voltage

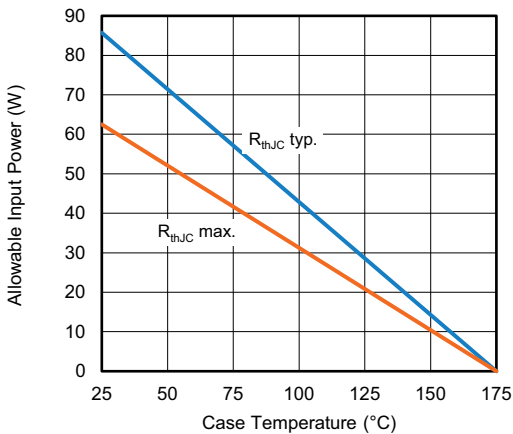

Fig. 7 - Forward Power Loss Characteristics

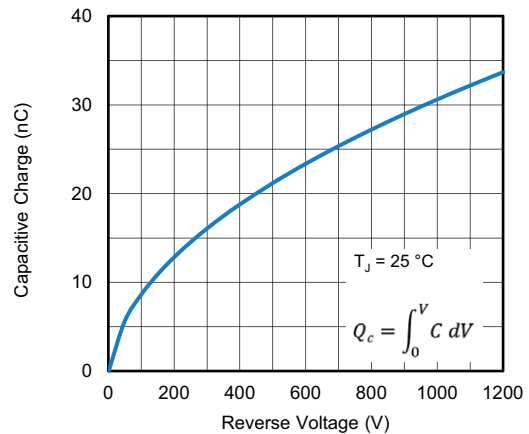
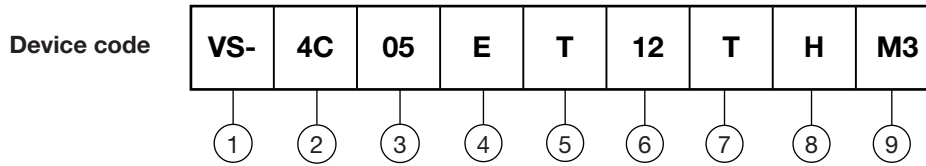

Fig. 9 - Typical Capacitive Charge vs. Reverse Voltage



## ORDERING INFORMATION TABLE



- 1** - Vishay Semiconductors product
- 2** - 4C = SiC diode, Generation 4
- 3** - Current rating (05 = 5 A)
- 4** - E = single diode
- 5** - Package TO-220
- 6** - Voltage rating: (12 = 1200 V)
- 7** - T = true 2 pin
- 8** - H = AEC-Q101 qualified
- 9** - Environmental digit:  
M3 = halogen-free, RoHS-compliant, and termination lead (Pb)-free

ORDERING INFORMATION			
PREFERRED P/N	UNIT WEIGHT	BASE QUANTITY	PACKAGING DESCRIPTION
VS-4C05ET12THM3	2 g	50 / tube	Antistatic plastic tubes

LINKS TO RELATED DOCUMENTS	
Dimensions	<a href="http://www.vishay.com/doc?96069">www.vishay.com/doc?96069</a>
Part marking information	<a href="http://www.vishay.com/doc?95391">www.vishay.com/doc?95391</a>

### TO-220AC 2L

**DIMENSIONS** in millimeters and inches

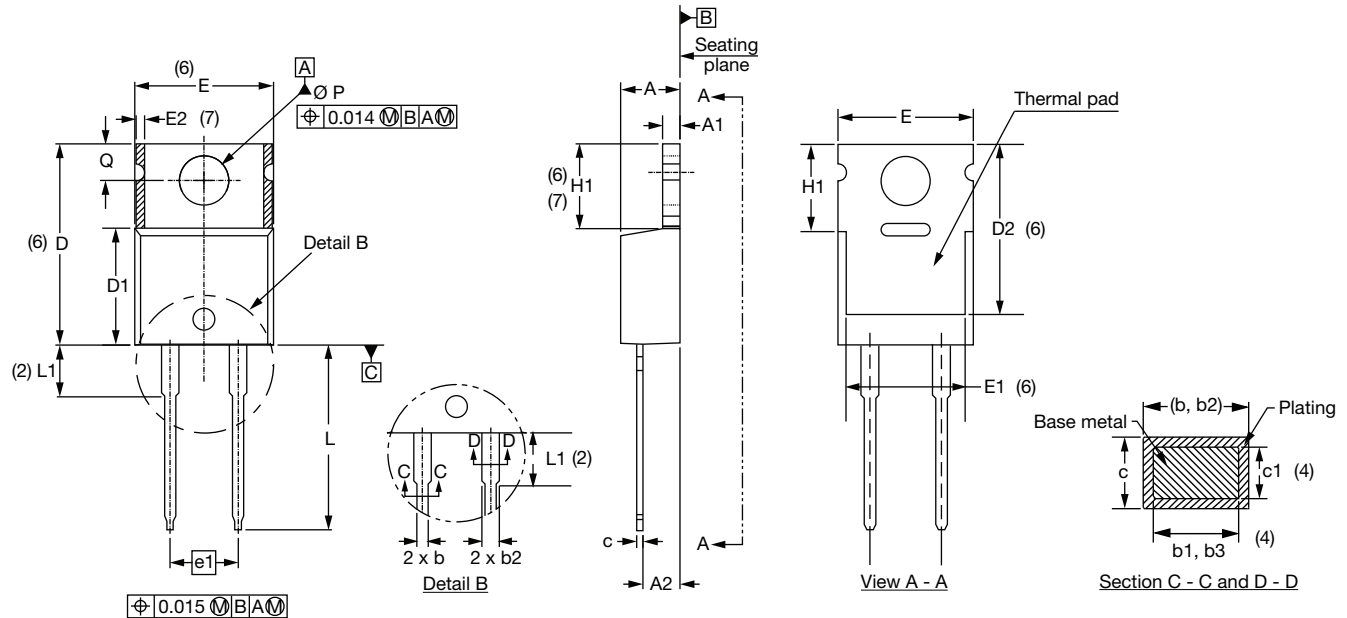

SYMBOL	MILLIMETERS		INCHES		NOTES
	MIN.	MAX.	MIN.	MAX.	
A	4.25	4.65	0.167	0.183	
A1	1.14	1.40	0.045	0.055	
A2	2.56	2.92	0.101	0.115	
b	0.69	1.01	0.027	0.040	
b1	0.38	0.97	0.015	0.038	4
b2	1.20	1.73	0.047	0.068	
b3	1.14	1.73	0.045	0.068	4
c	0.36	0.61	0.014	0.024	
c1	0.36	0.56	0.014	0.022	4
D	14.85	15.25	0.585	0.600	3
D1	8.38	9.02	0.330	0.355	
D2	11.68	12.88	0.460	0.507	6
E	10.11	10.51	0.398	0.414	3, 6

SYMBOL	MILLIMETERS		INCHES		NOTES
	MIN.	MAX.	MIN.	MAX.	
E1	6.86	8.89	0.270	0.350	6
E2	-	0.76	-	0.030	7
e1	4.88	5.28	0.192	0.208	
H1	5.84	6.86	0.230	0.270	6, 7
L	13.52	14.02	0.532	0.552	
L1	3.32	3.82	0.131	0.150	2
Ø P	3.54	3.73	0.139	0.147	
Q	2.60	3.00	0.102	0.118	

**Notes**

- (1) Dimensioning and tolerancing as per ASME Y14.5M-1994
- (2) Lead dimension and finish uncontrolled in L1
- (3) Dimension D, D1 and E do not include mold flash. Mold flash shall not exceed 0.127 mm (0.005") per side. These dimensions are measured at the outermost extremes of the plastic body
- (4) Dimension b1, b3 and c1 apply to base metal only
- (5) Controlling dimension: inches
- (6) Thermal pad contour optional within dimensions E, H1, D2 and E1
- (7) Dimension E2 x H1 define a zone where stamping and singulation irregularities are allowed
- (8) Outline conforms to JEDEC® TO-220, except D2, where JEDEC® minimum is 0.480"



## **Disclaimer**

ALL PRODUCT, PRODUCT SPECIFICATIONS AND DATA ARE SUBJECT TO CHANGE WITHOUT NOTICE TO IMPROVE RELIABILITY, FUNCTION OR DESIGN OR OTHERWISE.

Vishay Intertechnology, Inc., its affiliates, agents, and employees, and all persons acting on its or their behalf (collectively, "Vishay"), disclaim any and all liability for any errors, inaccuracies or incompleteness contained in any datasheet or in any other disclosure relating to any product.

Vishay makes no warranty, representation or guarantee regarding the suitability of the products for any particular purpose or the continuing production of any product. To the maximum extent permitted by applicable law, Vishay disclaims (i) any and all liability arising out of the application or use of any product, (ii) any and all liability, including without limitation special, consequential or incidental damages, and (iii) any and all implied warranties, including warranties of fitness for particular purpose, non-infringement and merchantability.

Statements regarding the suitability of products for certain types of applications are based on Vishay's knowledge of typical requirements that are often placed on Vishay products in generic applications. Such statements are not binding statements about the suitability of products for a particular application. It is the customer's responsibility to validate that a particular product with the properties described in the product specification is suitable for use in a particular application. Parameters provided in datasheets and / or specifications may vary in different applications and performance may vary over time. All operating parameters, including typical parameters, must be validated for each customer application by the customer's technical experts. Product specifications do not expand or otherwise modify Vishay's terms and conditions of purchase, including but not limited to the warranty expressed therein.

Hyperlinks included in this datasheet may direct users to third-party websites. These links are provided as a convenience and for informational purposes only. Inclusion of these hyperlinks does not constitute an endorsement or an approval by Vishay of any of the products, services or opinions of the corporation, organization or individual associated with the third-party website. Vishay disclaims any and all liability and bears no responsibility for the accuracy, legality or content of the third-party website or for that of subsequent links.

Vishay products are not designed for use in life-saving or life-sustaining applications or any application in which the failure of the Vishay product could result in personal injury or death unless specifically qualified in writing by Vishay. Customers using or selling Vishay products not expressly indicated for use in such applications do so at their own risk. Please contact authorized Vishay personnel to obtain written terms and conditions regarding products designed for such applications.

No license, express or implied, by estoppel or otherwise, to any intellectual property rights is granted by this document or by any conduct of Vishay. Product names and markings noted herein may be trademarks of their respective owners.