

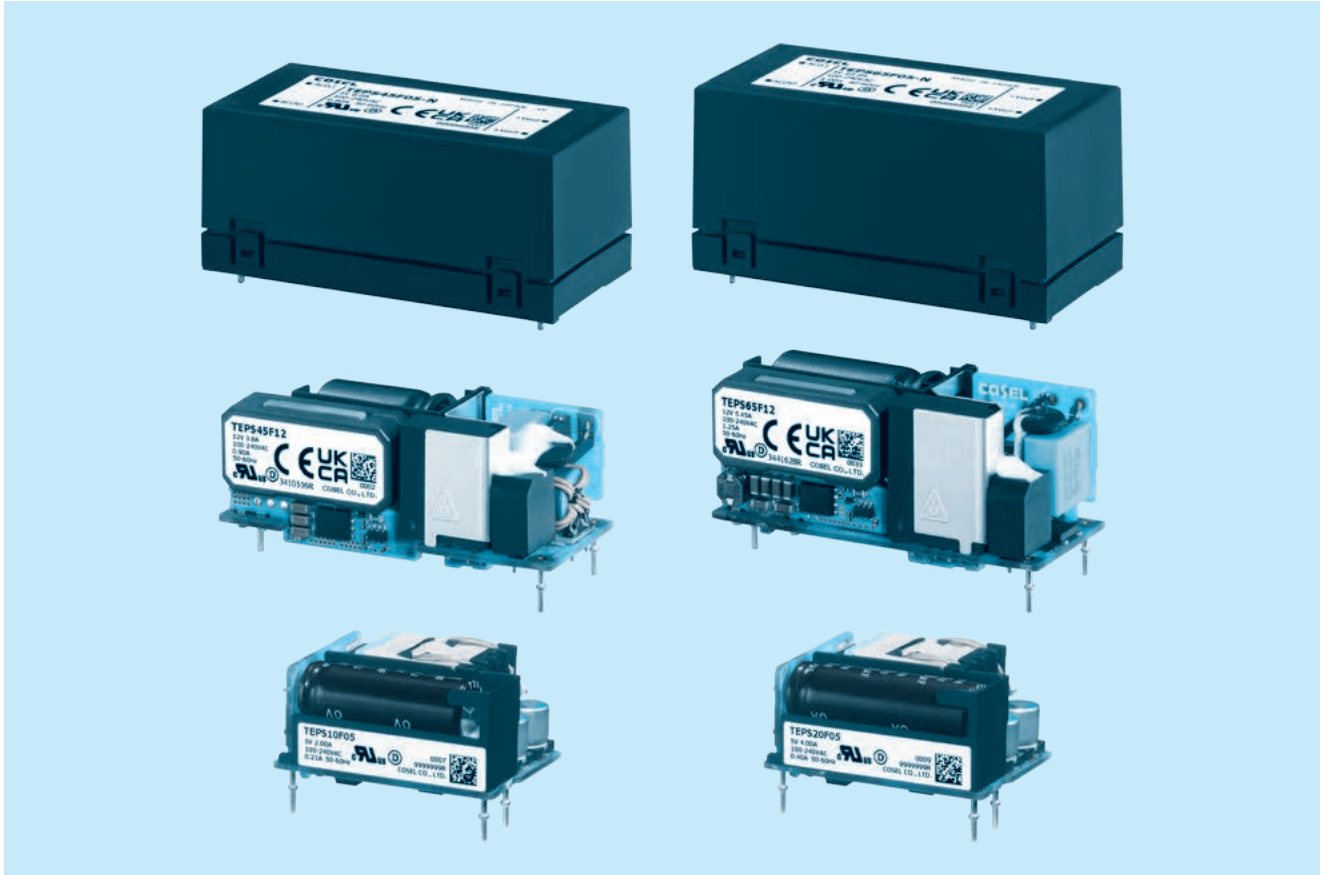

TEPS-series



Feature

- Small
- 1"×1.5" (TEPS10F/20F), 1"×2.3" (TEPS45F/65F)
- High efficiency
- Harmonic attenuator (Complies with IEC61000-3-2)
- Universal input (85-264VAC)
- Built-in inrush current, overcurrent and overvoltage protection circuits
- All in one type
- ClassII

Safety agency approvals

- UL62368-1, C-UL (equivalent to CAN/CSA-C22.2 No.62368-1), EN62368-1
- Complies with DEN-AN

5-year warranty (refer to Instruction Manual)

CE marking

- Low Voltage Directive
- RoHS Directive

UKCA marking

- Electrical Equipment Safety Regulations
- RoHS Regulations

EMI

- Complies with CISPR11-B, CISPR32-B, EN55011-B, EN55032-B, FCC Part 15-B, FCC Part 18-B, VCCI-B

EMS Compliance : EN61204-3, EN61000-6-2

- EN61000-4-2
- EN61000-4-3
- EN61000-4-4
- EN61000-4-5
- EN61000-4-6
- EN61000-4-8
- EN61000-4-11

TEPS10F

TEP S 10 F -

① ② ③ ④ ⑤ ⑥



Example recommended EMI/EMC filter
EAM-03-000



High voltage pulse noise type : EAP series
150KHz-1MHz (To safety ground the secondary
side) : EAC serie

*A higher current rating EMI/EMC filter
may be recommended in view of the
other devices that could be connected
in parallel with the power supply.

- ① Series name
- ② Single output
- ③ Output wattage
- ④ Universal input
- ⑤ Output voltage
- ⑥ Optional *1
E2: Low leakage current
For option details, refer to
Instruction Manual 8.

ClassII

This power supply is manufactured by SMD technology. The stress to PCB like twisting or bending causes the defect of the unit, so handle the unit with care.
*Make sure necessary tests will be carried out on your end equipment with the power supply installed in accordance with any required EMC/EMI regulations.

MODEL	TEPS10F05	TEPS10F12	TEPS10F15	TEPS10F24
MAX OUTPUT WATTAGE[W]	*2 10.0	10.2	10.5	10.8
DC OUTPUT	*2 5V 2.0A	12V 0.85A	15V 0.7A	24V 0.45A

SPECIFICATIONS

	MODEL	TEPS10F05	TEPS10F12	TEPS10F15	TEPS10F24	
INPUT	VOLTAGE[VAC]	*2 85 - 264 1 φ (Refer to "Derating" and Instruction Manual 3.1)				
	CURRENT[A]	ACIN 100V	0.21typ			
		ACIN 230V	0.12typ			
	FREQUENCY[Hz]	50 / 60 (45 - 440)				
	EFFICIENCY[%]	ACIN 100V	82.5typ	88.0typ	88.0typ	90.0typ
		ACIN 230V	84.0typ	88.0typ	88.0typ	90.0typ
	INRUSH CURRENT[A]	ACIN 100V	15typ (Io=100%) Ta=25°C at cold start			
ACIN 230V		35typ (Io=100%) Ta=25°C at cold start				
LEAKAGE CURRENT[ma]	0.1max (ACIN 264V, 60Hz, Io=100%, According to IEC62368-1, and DEN-AN)					
OUTPUT	VOLTAGE[V]	5	12	15	24	
	CURRENT[A]	*2 2.0	0.85	0.7	0.45	
	LINE REGULATION[mV]	*3 20max	48max	60max	96max	
	LOAD REGULATION[mV]	*3 40max	100max	120max	150max	
	RIPPLE[mVp-p]	*4 -20 to +60°C	200max	200max	200max	200max
	RIPPLE NOISE[mVp-p]	*4 -20 to +60°C	240max	240max	240max	240max
	TEMPERATURE REGULATION[mV]	0 to +60°C	50max	120max	150max	240max
		-20 to +60°C	60max	160max	200max	320max
	DRIFT[mV]	*5 20max	48max	60max	96max	
	START-UP TIME[ms]	80typ (ACIN 100/230V, Io=100%)				
	HOLD-UP TIME[ms]	15typ (ACIN 100V, Io=100%) / 110typ (ACIN 230V, Io=100%)				
OUTPUT VOLTAGE SETTING[V]	4.90 to 5.30	11.50 to 12.50	14.50 to 15.50	23.00 to 25.00		
PROTECTION CIRCUIT AND OTHERS	OVERCURRENT PROTECTION	Works over 105% of rating and recovers automatically				
	OVERVOLTAGE PROTECTION[V]	5.75 to 7.00	13.80 to 16.80	17.25 to 21.00	27.60 to 33.60	
	OPERATING INDICATION	Not provided				
	REMOTE SENSING	Not provided				
ISOLATION	INPUT-OUTPUT	3,000VAC 1minute, Cutoff current = 10mA, 500VDC 100MΩ min (At Room Temperature)				
ENVIRONMENT	OPERATING TEMP., HUMID. AND ALTITUDE	*2 -20 to +85°C, 20 - 90%RH (Non condensing), (Refer to "Derating"), 5,000m (16,500feet) max				
	STORAGE TEMP., HUMID. AND ALTITUDE	-40 to +85°C, 20 - 90%RH (Non condensing), 9,000m (30,000feet) max				
	VIBRATION	10 - 55Hz, 19.6m/s ² (2G), 3minutes period, 60minutes each along X, Y and Z axis				
	IMPACT	196.1m/s ² (20G), 11ms, once each X, Y and Z axis				
SAFETY AND NOISE REGULATIONS	AGENCY APPROVALS	UL62368-1, C-UL (equivalent to CAN/CSA-C22.2No.62368-1), EN62368-1, Complies with DEN-AN				
	CONDUCTED NOISE	*6 Complies with CISPR11-B, CISPR32-B, EN55011-B, EN55032-B, FCC Part 15-B, FCC Part 18-B, VCCI-B				
	HARMONIC ATTENUATOR	*7 Complies with EN61000-3-2 (Class A) (No built-in power factor correction)				
OTHERS	CASE SIZE/WEIGHT	25.4 X 21.6 X 38.1mm [1.00 X 0.85 X 1.50 inches] (W X H X D) / 30g max				
	COOLING METHOD	*2 Convection/Forced air (Requires external fan) (Refer to "Derating")				

- *1 The listed options may affect the published standard specifications. Please contact us for detailed product specifications.
- *2 Derating is required. Please contact us about the detail.
- *3 At low load conditions, the burst mode operation will start. To check load regulation, you will need to measure the characteristics at average mode with instruments.
- *4 This is the value that measured on measuring board with capacitor of 22 μF and 0.1 μF at 50mm from output terminal. (Refer to Instruction Manual)
- *5 Drift is the change in DC output for an eight hour period after a half-hour warm-up at 25°C, with the input voltage held constant at the rated input/output.
- *6 When secondary circuit will be connected to earth, the spec will be changed. (Refer to Instruction Manual 2)
- *7 Please contact us about another class. When two or more units are operating it may not comply with the IEC61000-3-2. Please contact us for details.
- * To meet the specification, do not operate overload condition.
- * Parallel operation is not possible.
- * Sound noise may be emitted from the power supply depending on operating conditions.

Block diagram

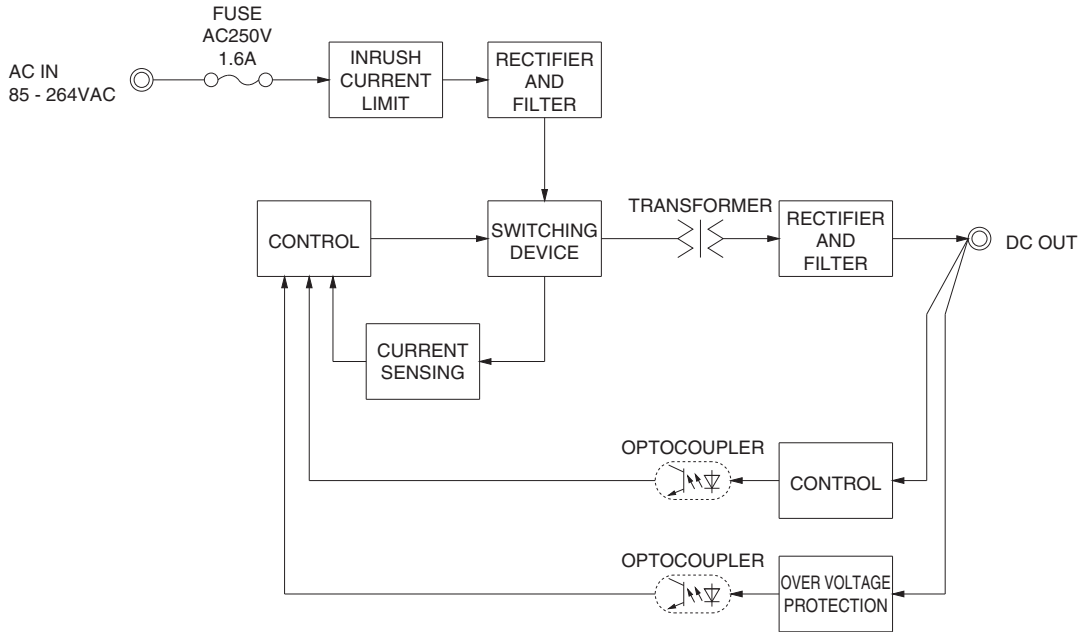

External view

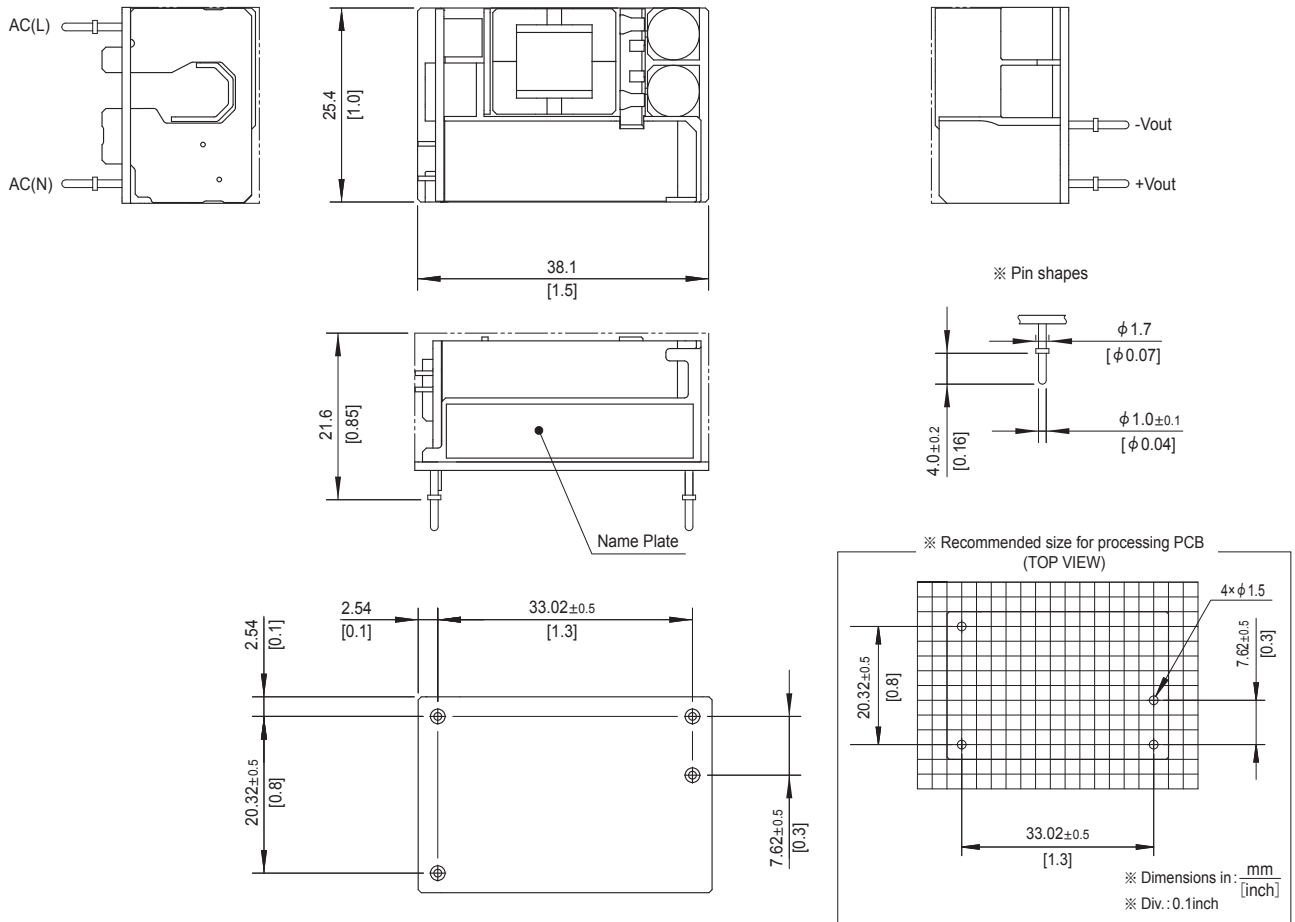

- ※ Dimensions in mm, []=inches
- ※ Tolerance : ± 1.5 [± 0.06]
- ※ Weight : 30g max
- ※ PCB Material / thickness : FR-4 / 1.1 [0.04]
- ※ Pin material : Copper
- ※ Plating treatment of pin : Lead free plating

TEPS20F

TEP S 20 F □ □ - □
 ① ② ③ ④ ⑤ ⑥



Example recommended EMI/EMC filter
EAM-03-000



High voltage pulse noise type : EAP series
150KHz-1MHz (To safety ground the secondary
side) : EAC serie

*A higher current rating EMI/EMC filter
may be recommended in view of the
other devices that could be connected
in parallel with the power supply.

- ① Series name
- ② Single output
- ③ Output wattage
- ④ Universal input
- ⑤ Output voltage
- ⑥ Optional *1
E2: Low leakage current
For option details, refer to
Instruction Manual 8.

□ Class II

This power supply is manufactured by SMD technology. The stress to PCB like twisting or bending causes the defect of the unit, so handle the unit with care.
*Make sure necessary tests will be carried out on your end equipment with the power supply installed in accordance with any required EMC/EMI regulations.

MODEL	TEPS20F05	TEPS20F12	TEPS20F15	TEPS20F24
MAX OUTPUT WATTAGE[W]	*2 20.0	20.4	20.25	20.4
DC OUTPUT	*2 5V 4.0A	12V 1.7A	15V 1.35A	24V 0.85A

SPECIFICATIONS

	MODEL	TEPS20F05	TEPS20F12	TEPS20F15	TEPS20F24	
INPUT	VOLTAGE[VAC]	*2 85 - 264 1 φ (Refer to "Derating" and Instruction Manual 3.1)				
	CURRENT[A]	ACIN 100V	0.40typ			
		ACIN 230V	0.23typ			
	FREQUENCY[Hz]	50 / 60 (45 - 440)				
	EFFICIENCY[%]	ACIN 100V	88.0typ	91.0typ	91.0typ	91.0typ
		ACIN 230V	90.0typ	92.0typ	92.0typ	92.0typ
INRUSH CURRENT[A]	ACIN 100V	15typ (Io=100%) Ta=25°C at cold start				
	ACIN 230V	35typ (Io=100%) Ta=25°C at cold start				
LEAKAGE CURRENT[ma]	0.1max (ACIN 264V, 60Hz, Io=100%, According to IEC62368-1, and DEN-AN)					
OUTPUT	VOLTAGE[V]	5	12	15	24	
	CURRENT[A]	*2 4.0	1.7	1.35	0.85	
	LOAD REGULATION[mV]	*3 20max	48max	60max	96max	
	LOAD REGULATION[mV]	*3 40max	100max	120max	150max	
	RIPPLE[mVp-p]	*4 -20 to +55°C *5 200max	200max	200max	200max	
	RIPPLE NOISE[mVp-p]	*4 -20 to +55°C *5 240max	240max	240max	240max	
	TEMPERATURE REGULATION[mV]	0 to +55°C *5	50max	120max	150max	240max
		-20 to +55°C *5	60max	160max	200max	320max
	DRIFT[mV]	*6 20max	48max	60max	96max	
	START-UP TIME[ms]	80typ (ACIN 100/230V, Io=100%)				
HOLD-UP TIME[ms]	10typ (ACIN 100V, Io=100%) / 70typ (ACIN 230V, Io=100%)					
OUTPUT VOLTAGE SETTING[V]	4.90 to 5.30	11.50 to 12.50	14.50 to 15.50	23.00 to 25.00		
PROTECTION CIRCUIT AND OTHERS	OVERCURRENT PROTECTION	Works over 105% of rating and recovers automatically				
	OVERVOLTAGE PROTECTION[V]	5.75 to 7.00	13.80 to 16.80	17.25 to 21.00	27.60 to 33.60	
	OPERATING INDICATION	Not provided				
	REMOTE SENSING	Not provided				
ISOLATION	INPUT-OUTPUT	3,000VAC 1minute, Cutoff current = 10mA, 500VDC 100MΩ min (At Room Temperature)				
ENVIRONMENT	OPERATING TEMP., HUMID. AND ALTITUDE *2	-20 to +85°C, 20 - 90%RH (Non condensing), (Refer to "Derating"), 5,000m (16,500feet) max				
	STORAGE TEMP., HUMID. AND ALTITUDE	-40 to +85°C, 20 - 90%RH (Non condensing), 9,000m (30,000feet) max				
	VIBRATION	10 - 55Hz, 19.6m/s ² (2G), 3minutes period, 60minutes each along X, Y and Z axis				
	IMPACT	196.1m/s ² (20G), 11ms, once each X, Y and Z axis				
SAFETY AND NOISE REGULATIONS	AGENCY APPROVALS	UL62368-1, C-UL (equivalent to CAN/CSA-C22.2No.62368-1), EN62368-1, Complies with DEN-AN				
	CONDUCTED NOISE *7	Complies with CISPR11-B, CISPR32-B, EN55011-B, EN55032-B, FCC Part 15-B, FCC Part 18-B, VCCI-B				
	HARMONIC ATTENUATOR *8	Complies with EN61000-3-2 (Class A) (No built-in power factor correction)				
OTHERS	CASE SIZE/WEIGHT	25.4 X 21.6 X 38.1mm [1.00 X 0.85 X 1.50 inches] (W X H X D) / 30g max				
	COOLING METHOD *2	Convection/Forced air (Requires external fan) (Refer to "Derating")				

- *1 The listed options may affect the published standard specifications. Please contact us for detailed product specifications.
- *2 Derating is required. Please contact us about the detail.
- *3 At low load conditions, the burst mode operation will start. To check load regulation, you will need to measure the characteristics at average mode with instruments.
- *4 This is the value that measured on measuring board with capacitor of 22 μF and 0.1 μF at 50mm from output terminal. (Refer to Instruction Manual)
- *5 5V output product, the maximum temperature of 50°C.
- *6 Drift is the change in DC output for an eight hour period after a half-hour warm-up at 25°C, with the input voltage held constant at the rated input/output.
- *7 When secondary circuit will be connected to earth, the spec will be changed. (Refer to Instruction Manual 2)
- *8 Please contact us about another class. When two or more units are operating it may not comply with the IEC61000-3-2. Please contact us for details.
- * To meet the specification, do not operate overload condition.
- * Parallel operation is not possible.
- * Sound noise may be emitted from the power supply depending on operating conditions.

Block diagram

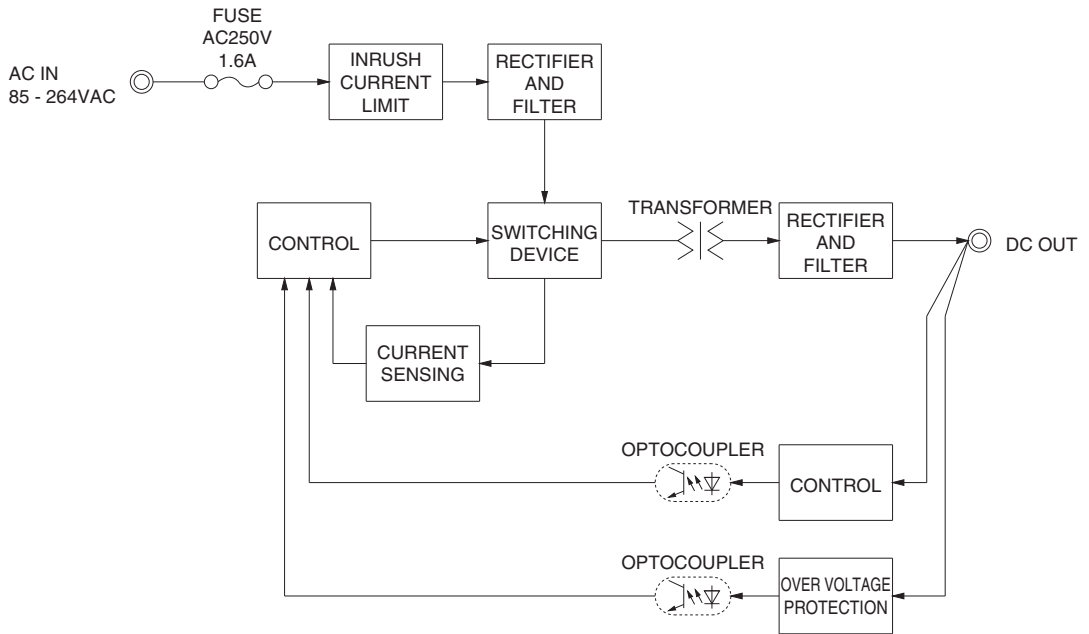

External view

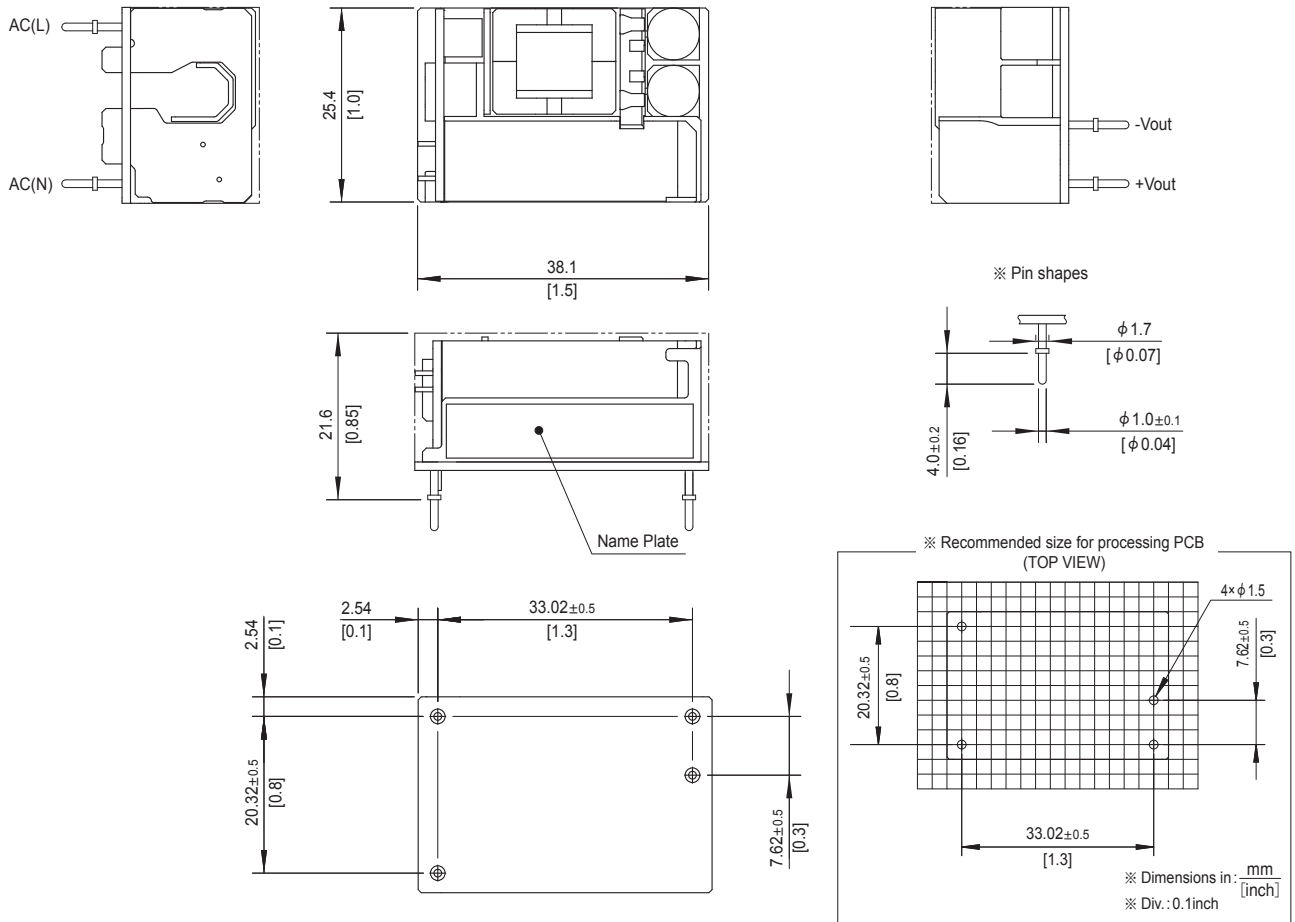

- ※ Dimensions in mm, []=inches
- ※ Tolerance : ±1.5 [±0.06]
- ※ Weight : 30g max
- ※ PCB Material / thickness : FR-4 / 1.1 [0.04]
- ※ Pin material : Copper
- ※ Plating treatment of pin : Lead free plating

TEPS45F

TEP S 45 F □ □ - □
 ① ② ③ ④ ⑤ ⑥

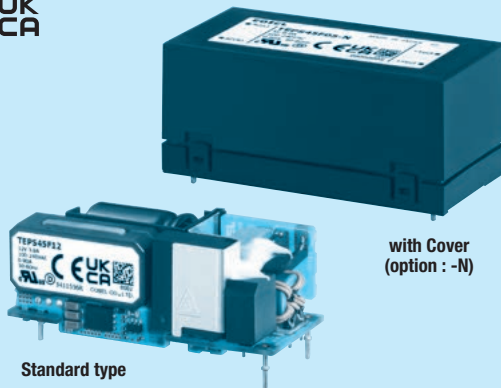

Standard type

with Cover
(option : -N)

Example recommended EMI/EMC filter
EAM-03-000



High voltage pulse noise type : EAP series
150KHz-1MHz (To safety ground the secondary
side) : EAC serie

*A higher current rating EMI/EMC filter
may be recommended in view of the
other devices that could be connected
in parallel with the power supply.

- ① Series name
- ② Single output
- ③ Output wattage
- ④ Universal input
- ⑤ Output voltage
- ⑥ Optional *1
- E2: Low leakage current
- H : with output peak current (12V,24V)
- N : with cover
- For option details, refer to Instruction Manual 8.

□ Class II

This power supply is manufactured by SMD technology. The stress to PCB like twisting or bending causes the defect of the unit, so handle the unit with care.

*Make sure necessary tests will be carried out on your end equipment with the power supply installed in accordance with any required EMC/EMI regulations.

MODEL	TEPS45F05	TEPS45F12	TEPS45F12-H	TEPS45F24	TEPS45F24-H
MAX OUTPUT WATTAGE[W]	40.0	45.6	45.6 (65.4)	45.6	45.6 (66.0)
DC OUTPUT	5V 8.0A	12V 3.8A	12V 3.8 (5.45)A	24V 1.9A	24V 1.9 (2.75)A

SPECIFICATIONS

MODEL	TEPS45F05	TEPS45F12	TEPS45F12-H	TEPS45F24	TEPS45F24-H
INPUT	VOLTAGE [VAC] *2 85 - 264 1 φ (Refer to "Derating" and Instruction Manual 3.1) CURRENT [A] ACIN 100V 0.80typ / ACIN 230V 0.45typ / ACIN 230V 0.50typ FREQUENCY [Hz] 50 / 60 (45 - 66) EFFICIENCY [%] ACIN 100V 90.0typ / ACIN 230V 90.5typ / ACIN 230V 91.5typ INRUSH CURRENT [A] ACIN 100V 30typ (Io=100%) Ta=25°C at cold start / ACIN 230V 65typ (Io=100%) Ta=25°C at cold start LEAKAGE CURRENT[mA] 0.25max (ACIN 264V, 60Hz, Io=100%, According to IEC62368-1, and DEN-AN)				
OUTPUT	VOLTAGE [V] 5 / 12 / 12 / 24 / 24 CURRENT [A] *2 8.0 / 3.8 / 3.8 (Peak5.45) / 1.9 / 1.9 (Peak 2.75) LINE REGULATION [mV] *3 20max / 48max / 48max / 96max / 96max LOAD REGULATION [mV] *3 40max / 100max / 100max / 150max / 150max RIPPLE [mVp-p] *4 -10 to +50°C *5 240max / 300max / 300max / 360max / 360max RIPPLE NOISE [mVp-p] *4 -10 to +50°C *5 300max / 380max / 380max / 480max / 480max TEMPERATURE REGULATION [mV] 0 to +50°C *5 50max / 120max / 120max / 240max / 240max DRIFT [mV] *6 -10 to +50°C *5 60max / 150max / 150max / 290max / 290max START-UP TIME [ms] 200typ (ACIN 100/230V, Io=100%) HOLD-UP TIME [ms] 10typ (ACIN 100V, Io=80%) / 60typ (ACIN 230V, Io=100%) OUTPUT VOLTAGE SETTING [V] 4.90 to 5.30 / 11.50 to 12.50 / 11.50 to 12.50 / 23.00 to 25.00 / 23.00 to 25.00				
PROTECTION CIRCUIT AND OTHERS	OVERCURRENT PROTECTION Works over 105% of rating (works over 101% of peak current at option -H) and recovers automatically OVERVOLTAGE PROTECTION [V] 5.50 to 6.50 / 13.20 to 15.60 / 13.20 to 15.60 / 26.40 to 31.20 / 26.40 to 31.20 OPERATING INDICATION Not provided REMOTE SENSING Not provided				
ISOLATION	INPUT-OUTPUT 3,000VAC 1minute, Cutoff current = 10mA, 500VDC 100MΩ min (At Room Temperature)				
ENVIRONMENT	OPERATING TEMP., HUMID. AND ALTITUDE *2 -10 to +70°C, 20 - 90%RH (Non condensing), (Refer to "Derating"), 5,000m (16,500feet) max STORAGE TEMP., HUMID. AND ALTITUDE -20 to +75°C, 20 - 90%RH (Non condensing), 9,000m (30,000feet) max VIBRATION 10 - 55Hz 19.6m/s ² (2G), 3minutes period, 60minutes each along X, Y and Z axis IMPACT 196.1m/s ² (20G), 11ms, once each X, Y and Z axis				
SAFETY AND NOISE REGULATIONS	AGENCY APPROVALS UL62368-1, C-UL (equivalent to CAN/CSA-C22.2 No.62368-1), EN62368-1, Complies with DEN-AN CONDUCTED NOISE *7 Complies with CISPR11-B, CISPR32-B, EN55011-B, EN55032-B, FCC Part 15-B, FCC Part 18-B, VCCI-B HARMONIC ATTENUATOR *8 Complies with IEC61000-3-2 (Class A) (No built-in power factor correction)				
OTHERS	CASE SIZE/WEIGHT 25.4 X 24.0 X 58.5mm [1.00 X 0.94 X 2.30 inches] (W X H X D) / 60g max (with cover : 80g max) COOLING METHOD *2 Convection/Forced air (Requires external fan)(Refer to "Derating")				

*1 The listed options may affect the published standard specifications. Please contact us for detailed product specifications.
 *2 Derating is required. () means peak current. There is a possibility that an internal device is damaged when the specification is exceeded. Please contact us about the detail.
 *3 At low load conditions, the burst mode operation will start. To check load regulation, you will need to measure the characteristics at average mode with instruments.
 *4 This is the value that measured on measuring board with capacitor of 22μF and 0.1μF at 50mm from output terminal. (Refer to Instruction Manual)
 *5 5V, 12V output product, the maximum temperature of 40°C.
 *6 Drift is the change in DC output for an eight hour period after a half-hour warm-up at 25°C, with the input voltage held constant at the rated input/output.
 *7 When secondary circuit will be connected to earth, the spec will be changed. (Refer to Instruction Manual 2)
 *8 Please contact us about another class. When two or more units are operating it may not comply with the IEC61000-3-2. Please contact us for details.
 * To meet the specification, do not operate overload condition.
 * Parallel operation is not possible.
 * Sound noise may be emitted from the power supply depending on operating conditions.

Block diagram

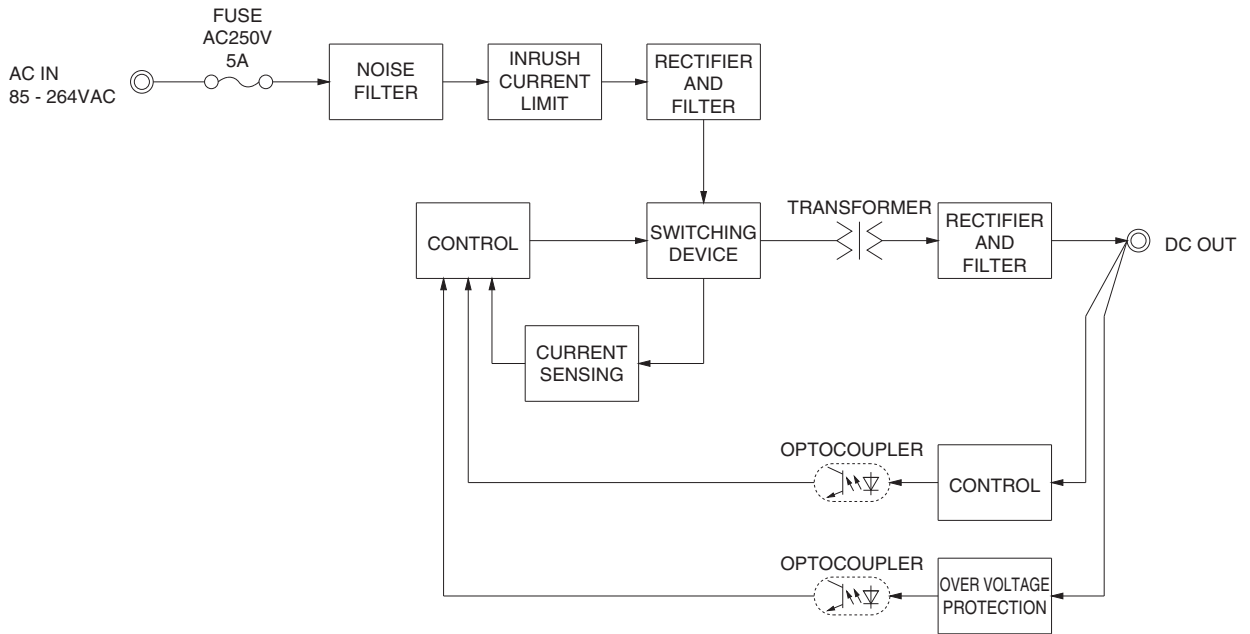

External view

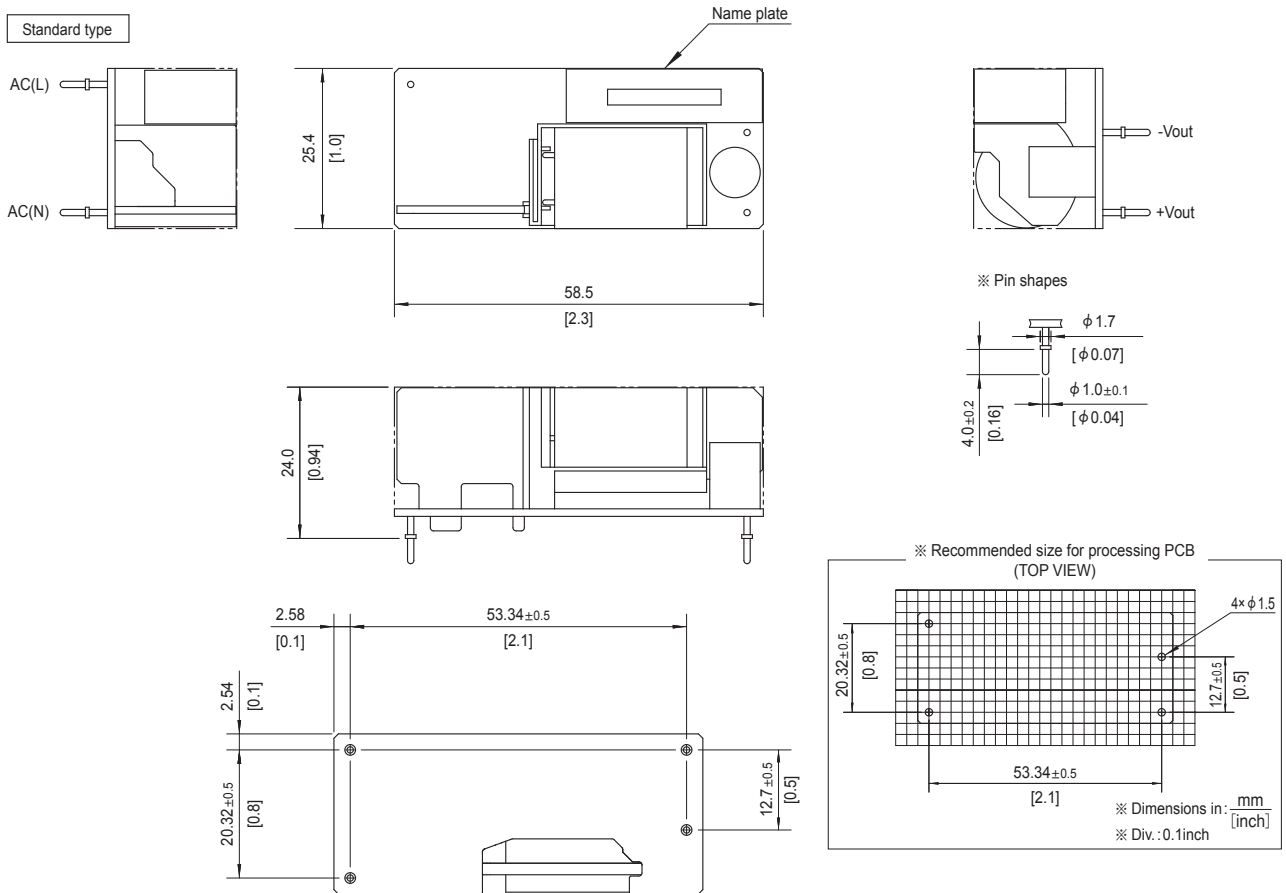

- ※ Dimensions in mm, []=inches
- ※ Tolerance : ± 1.5 [± 0.06]
- ※ Weight : 60g max
- ※ PCB Material / thickness : FR-4 / 1.1 [0.04]
- ※ Pin material : Copper
- ※ Plating treatment of pin : Lead free plating

External view

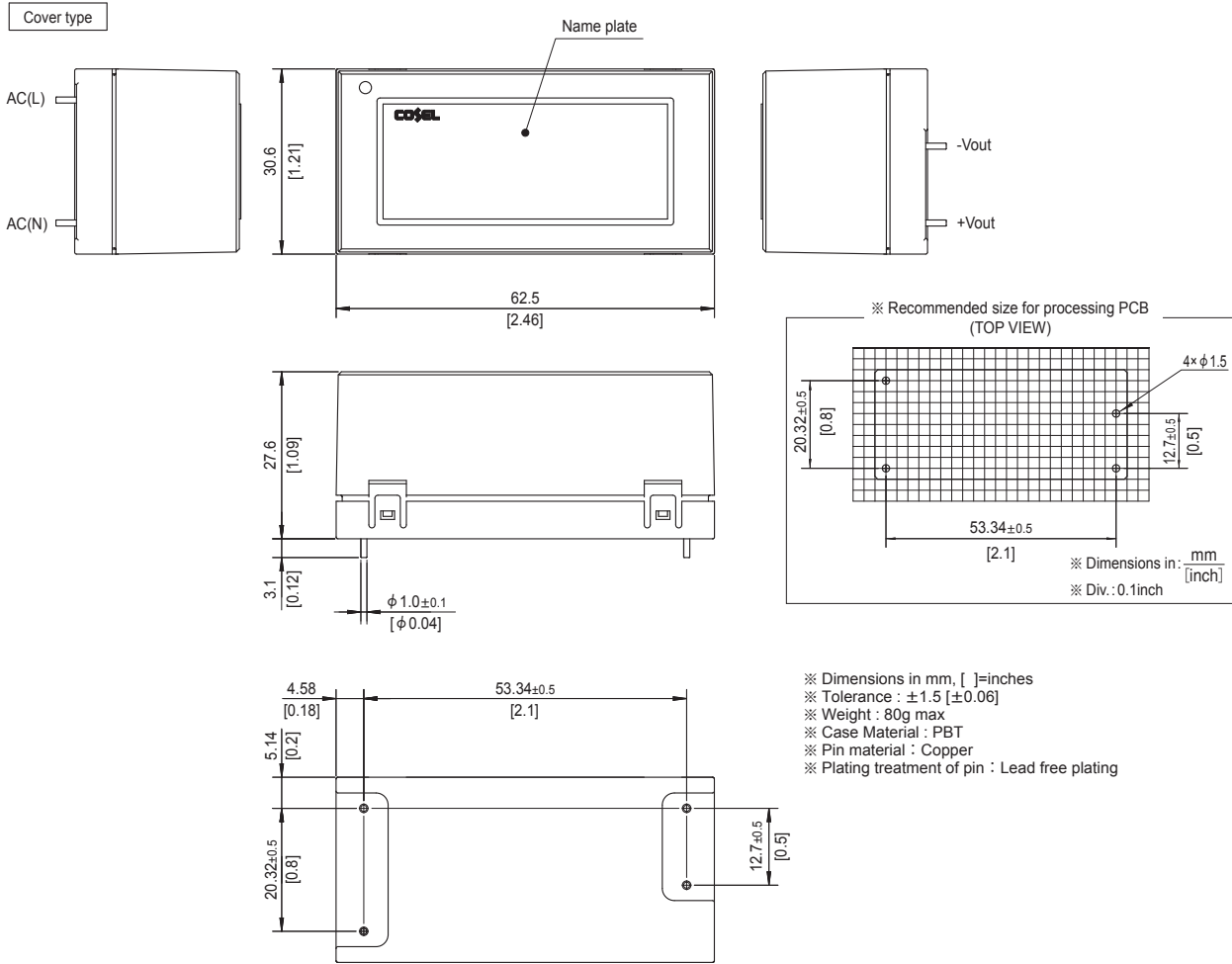

TEPS65F

TEP S 65 F -

① ② ③ ④ ⑤ ⑥

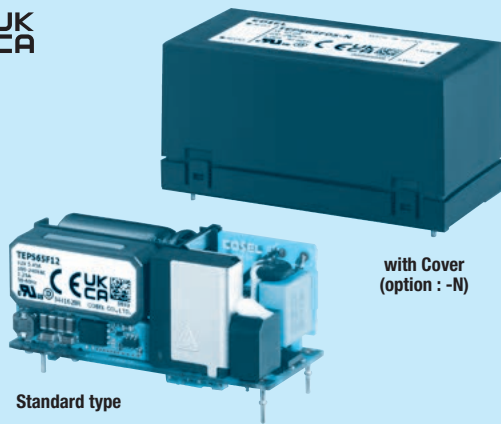

Example recommended EMI/EMC filter
EAM-03-000



High voltage pulse noise type : EAP series
150KHz-1MHz (To safety ground the secondary
side) : EAC serie

*A higher current rating EMI/EMC filter
may be recommended in view of the
other devices that could be connected
in parallel with the power supply.

- ① Series name
- ② Single output
- ③ Output wattage
- ④ Universal input
- ⑤ Output voltage
- ⑥ Optional *1
- E2: Low leakage current
- H : with output peak current (12V,24V)
- N : with cover
- For option details, refer to Instruction Manual 8.

ClassII

This power supply is manufactured by SMD technology. The stress to PCB like twisting or bending causes the defect of the unit, so handle the unit with care.
*Make sure necessary tests will be carried out on your end equipment with the power supply installed in accordance with any required EMC/EMI regulations.

MODEL	TEPS65F05	TEPS65F12	TEPS65F12-H	TEPS65F24	TEPS65F24-H
MAX OUTPUT WATTAGE [W]	50.0	65.4	65.4 (90.0)	66.0	66.0 (90.0)
DC OUTPUT	5V 10.0A	12V 5.45A	12V 5.45 (7.50)A	24V 2.75A	24V 2.75 (3.75)A

SPECIFICATIONS

MODEL	TEPS65F05	TEPS65F12	TEPS65F12-H	TEPS65F24	TEPS65F24-H
INPUT	VOLTAGE [VAC] *2 85 - 264 1 φ (Refer to "Derating" and Instruction Manual 3.1)				
CURRENT [A]	ACIN 100V	1.00typ	1.25typ		
	ACIN 230V	0.55typ	0.70typ		
FREQUENCY [Hz]	50 / 60 (45 - 66)				
EFFICIENCY [%]	ACIN 100V	90.0typ	91.5typ	91.5typ	92.5typ
	ACIN 230V	91.5typ	93.0typ	93.0typ	93.5typ
INRUSH CURRENT [A]	ACIN 100V	30typ (Io=100%) Ta=25°C at cold start			
	ACIN 230V	65typ (Io=100%) Ta=25°C at cold start			
LEAKAGE CURRENT [mA]	0.25max (ACIN 264V, 60Hz, Io=100%, According to IEC62368-1, and DEN-AN)				
OUTPUT	VOLTAGE [V]	5	12	12	24
CURRENT [A] *2	10.0	5.45	5.45 (Peak 7.50)	2.75	2.75 (Peak 3.75)
LINE REGULATION [mV] *3	20max	48max	48max	96max	96max
LOAD REGULATION [mV] *3	40max	100max	100max	150max	150max
RIPPLE [mVp-p] *4	240max	300max	300max	360max	360max
RIPPLE NOISE [mVp-p] *4	300max	380max	380max	480max	480max
TEMPERATURE REGULATION [mV]	0 to +50°C *5	50max	120max	120max	240max
	-10 to +50°C *5	60max	150max	150max	290max
DRIFT [mV] *6	20max	48max	48max	96max	96max
START-UP TIME [ms]	500typ (ACIN 100/230V, Io=100%)				
HOLD-UP TIME [ms]	10typ (ACIN 100V, Io=80%) / 60typ (ACIN 230V, Io=100%)				
OUTPUT VOLTAGE SETTING [V]	4.90 to 5.30	11.50 to 12.50	11.50 to 12.50	23.00 to 25.00	23.00 to 25.00
PROTECTION CIRCUIT AND OTHERS	OVERCURRENT PROTECTION	Works over 105% of rating (works over 101% of peak current at option -H) and recovers automatically			
	OVERVOLTAGE PROTECTION [V]	5.50 to 6.50	13.20 to 15.60	13.20 to 15.60	26.40 to 31.20
	OPERATING INDICATION	Not provided			
REMOTE SENSING	Not provided				
ISOLATION	INPUT-OUTPUT	3,000VAC 1minute, Cutoff current = 10mA, 500VDC 100MΩ min (At Room Temperature)			
ENVIRONMENT	OPERATING TEMP., HUMID. AND ALTITUDE *2	-10 to +70°C, 20 - 90%RH (Non condensing), (Refer to "Derating"), 5,000m (16,500feet) max			
	STORAGE TEMP., HUMID. AND ALTITUDE	-20 to +75°C, 20 - 90%RH (Non condensing), 9,000m (30,000feet) max			
	VIBRATION	10 - 55Hz 19.6m/s ² (2G), 3minutes period, 60minutes each along X, Y and Z axis			
IMPACT	196.1m/s ² (20G), 11ms, once each X, Y and Z axis				
SAFETY AND NOISE REGULATIONS	AGENCY APPROVALS	UL62368-1, C-UL (equivalent to CAN/CSA-C22.2 No.62368-1), EN62368-1, Complies with DEN-AN			
	CONDUCTED NOISE *7	Complies with CISPR11-B, CISPR32-B, EN55011-B, EN55032-B, FCC Part 15-B, FCC Part 18-B, VCCI-B			
	HARMONIC ATTENUATOR *8	Complies with IEC61000-3-2 (Class A) (No built-in power factor correction)			
OTHERS	CASE SIZE/WEIGHT	25.4 X 27.5 X 58.5mm [1.00 X 1.08 X 2.30 inches] (W X H X D) / 70g max (with cover : 90g max)			
	COOLING METHOD *2	Convection/Forced air (Requires external fan) (Refer to "Derating")			

- *1 The listed options may affect the published standard specifications. Please contact us for detailed product specifications.
- *2 Derating is required. () means peak current. There is a possibility that an internal device is damaged when the specification is exceeded. Please contact us about the detail.
- *3 At low load conditions, the burst mode operation will start. To check load regulation, you will need to measure the characteristics at average mode with instruments.
- *4 This is the value that measured on measuring board with capacitor of 22μF and 0.1μF at 50mm from output terminal. (Refer to Instruction Manual)
- *5 12V output product, the maximum temperature of 45°C.
- *6 Drift is the change in DC output for an eight hour period after a half-hour warm-up at 25°C, with the input voltage held constant at the rated input/output.
- *7 When secondary circuit will be connected to earth, the spec will be changed. (Refer to Instruction Manual 2)
- *8 Please contact us about another class. When two or more units are operating it may not comply with the IEC61000-3-2. Please contact us for details.
- * To meet the specification, do not operate overload condition.
- * Parallel operation is not possible.
- * Sound noise may be emitted from the power supply depending on operating conditions.

Block diagram

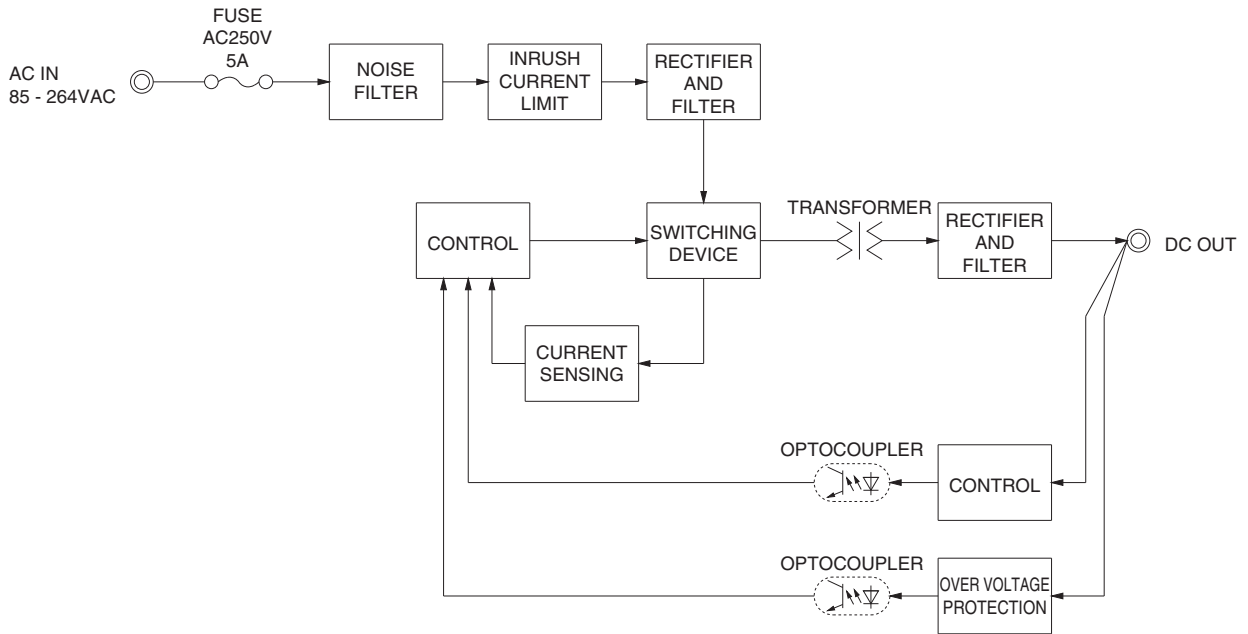

External view

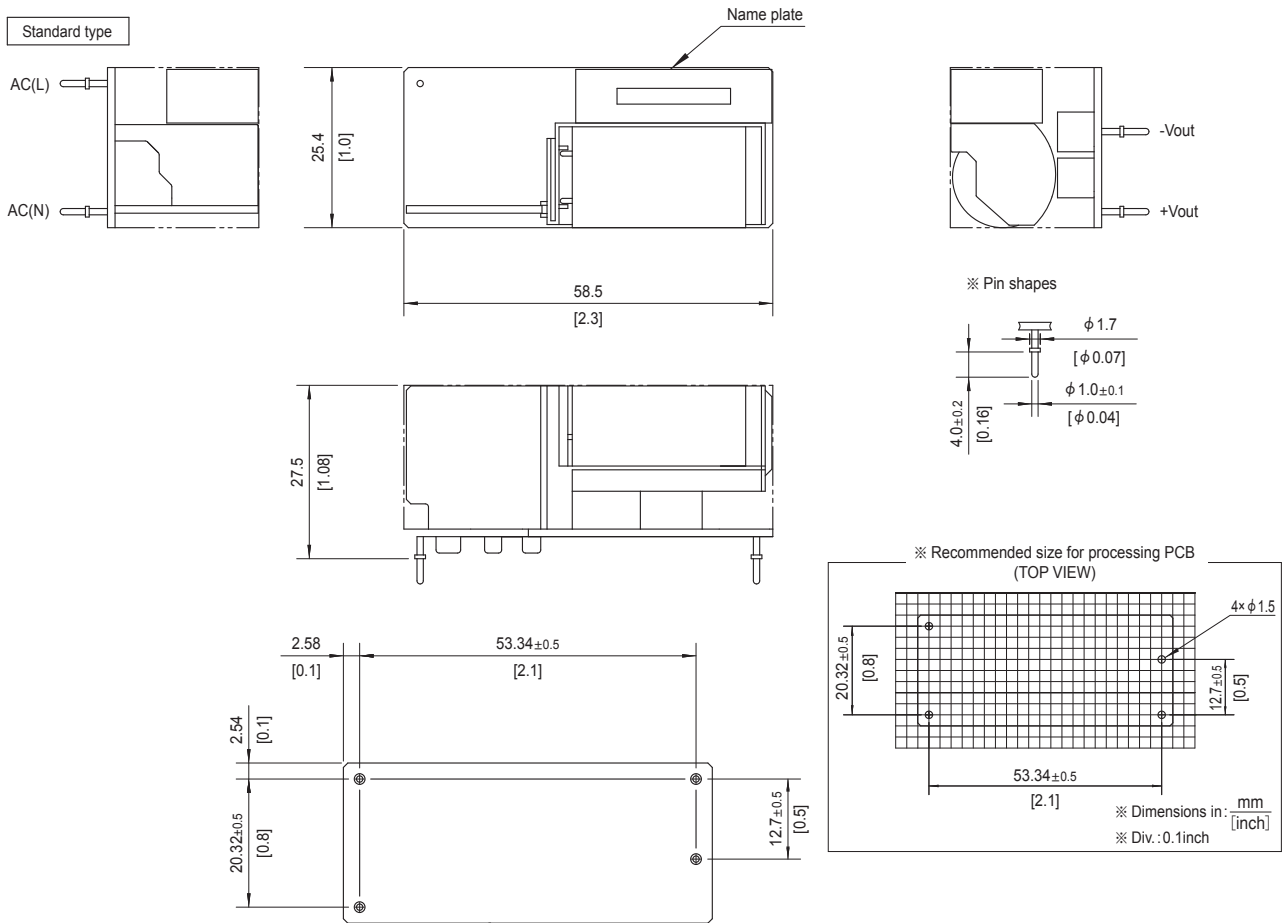

- ※ Dimensions in mm, []=inches
- ※ Tolerance : ±1.5 [±0.06]
- ※ Weight : 70g max
- ※ PCB Material / thickness : FR-4 / 1.1 [0.04]
- ※ Pin material : Copper
- ※ Plating treatment of pin : Lead free plating

External view

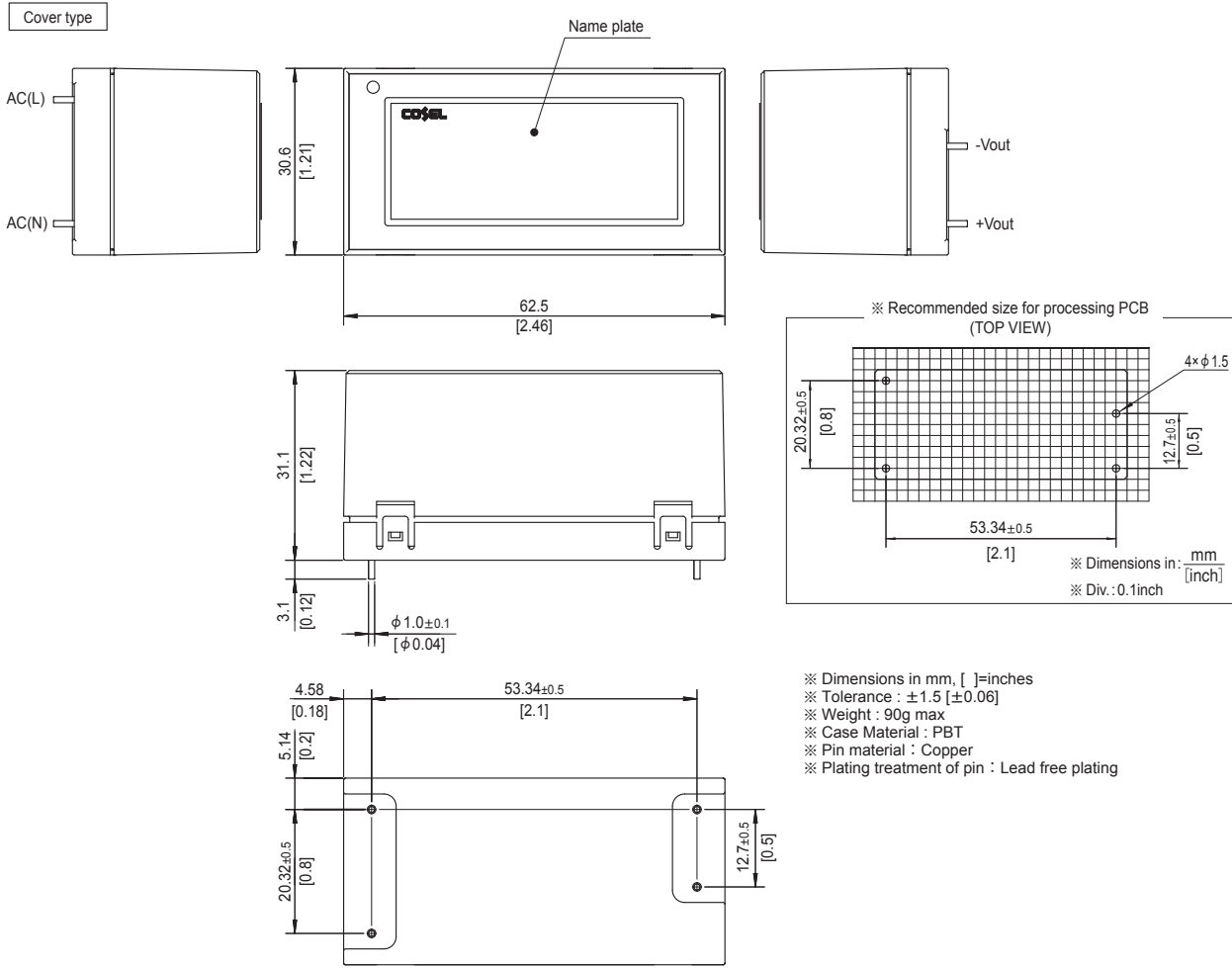

Pin Configuration

●TEPS10F/TEPS20F

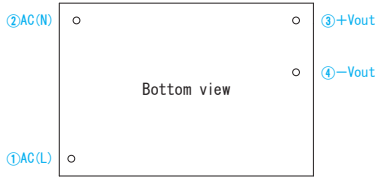

No.	Pin connection	Function
①	AC (L)	AC input
②	AC (N)	
③	+Vout	+DC output
④	-Vout	-DC output

●TEPS45F/TEPS65F

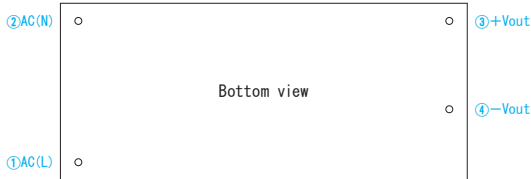

Implementation • Mounting Method

Mounting method

■When two or more power supplies are used side by side, position them with proper intervals to allow enough air ventilation. The temperature around each power supply should not exceed the temperature range shown in derating curve.

■Standard model can be mounted in the mounting position shown in the figure below.

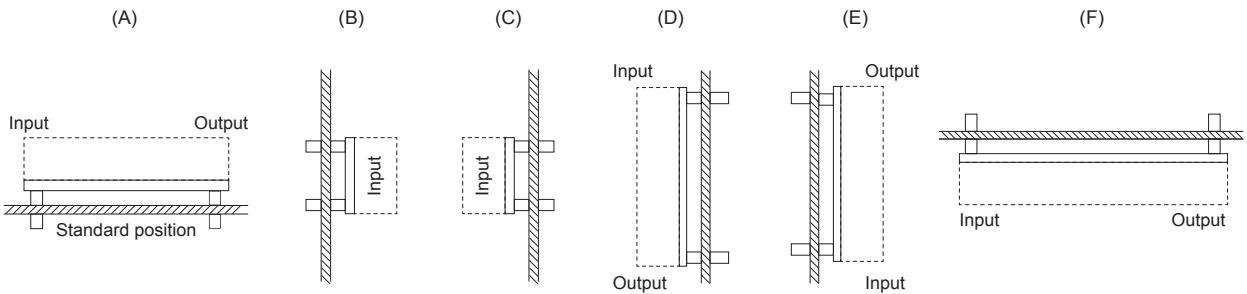

■Option-N model can be mounted in the mounting position shown in the figure below. The installation of (F) possible only forced air cooling.

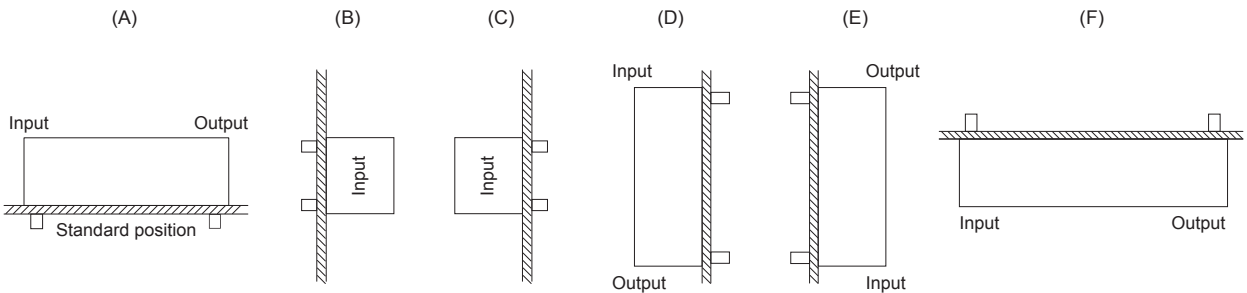

■Avoid placing the AC input line pattern layout underneath the unit. It will increase the line conducted noise. Make sure to leave an ample distance between the line pattern layout and the unit. Also avoid placing the DC output line pattern underneath the unit because it may increase the output noise. Lay out the pattern away from the unit.

■When installing the components (inclusive chassis) or pattern which is a foreign potentials around the unit, keep the distance for more than 5mm (except -N model).

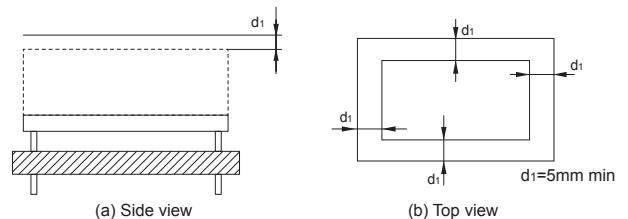
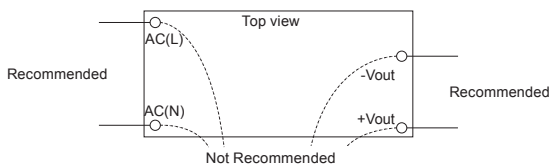

■Do not touch any SMD components on the unit and soldering points.

Implementation • Mounting Method

Soldering

- Flow soldering: 260°C for up to 15 seconds.
- Soldering iron (26W): 450°C for up to 5 seconds.

Stress to the pins

- Applying excessive stress to the input or output pins of the power module may damage internal connections. Avoid applying stress in excess of that shown in right figure.
- Input/output pin are soldered to the PCB internally. Do not pull or bend a lead powerfully.
- If it is expected that stress is applied to the input/output pin due to vibration or impact, reduce the stress to the pin by taking such measures as fixing the unit to the PCB by silicone rubber, etc.

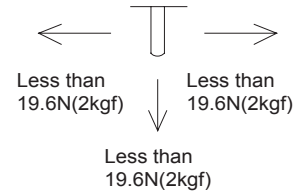

Derating

Derating curve for input voltage

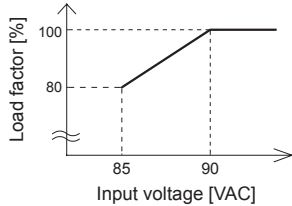

TEPS10F

Ambient temperature derating curve at rated input (Reference value)

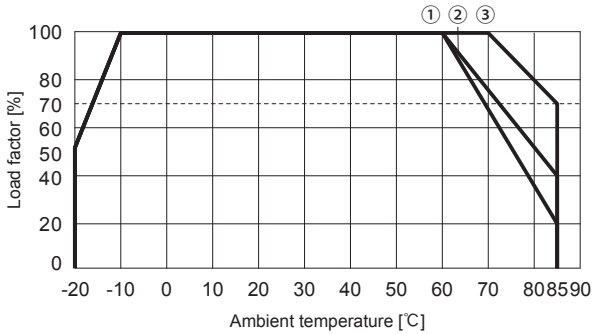

TEPS20F

Ambient temperature derating curve at rated input (Reference value)

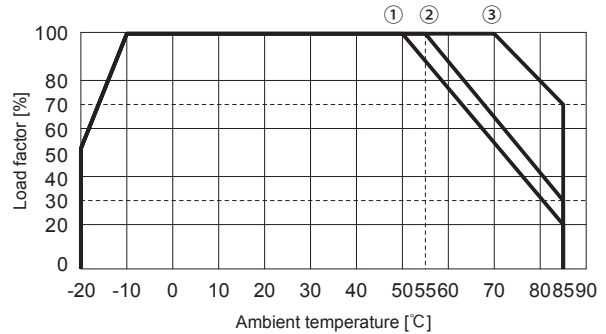

Cooling method	Output voltage	Mounting method
		A, B, C, D, E, F
Convection	5V, 12V	①
	15V, 24V	②
Forced air (0.5m ³ /min)	5V, 12V, 15V, 24V	③

- As example, these derating curves have been decided at the below PCB condition.
 - FR-4 (Double-sided)
 - 127.0mm×76.2mm×1.6mm
 - Copper foil thickness : 70μm

Cooling method	Output voltage	Mounting method
		A, B, C, D, E, F
Convection	5V	①
	12V, 15V, 24V	②
Forced air (0.5m ³ /min)	5V, 12V, 15V, 24V	③

- As example, these derating curves have been decided at the below PCB condition.
 - FR-4 (Double-sided)
 - 127.0mm×76.2mm×1.6mm
 - Copper foil thickness : 70μm

● TEPS45F

Ambient temperature derating curve at rated input (Reference value)

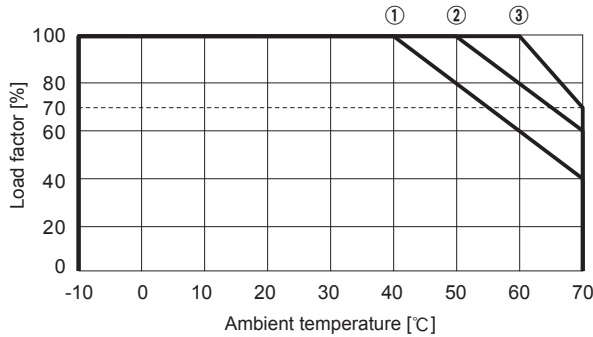

Cooling method	Output voltage	Mounting method	
		A, B, C, D, E, F	
Convection	5V	①	
	12V	①	
	24V	②	
Forced air (0.5m ³ /min)	5V, 12V, 24V	③	

■As example, these derating curves have been decided at the below PCB condition.

- FR-4 (Double-sided)
- 203.2mm×76.2mm×1.6mm
- Copper foil thickness : 70μm

● TEPS65F

Ambient temperature derating curve at rated input (Reference value)

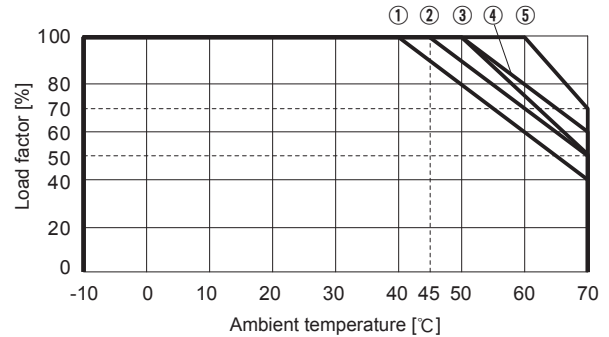

Cooling method	Output voltage	Mounting method		
		A, B, C, E, D, F		
Convection	5V	③	③	②
	12V	②	①	①
	24V	④	②	②
Forced air (0.5m ³ /min)	5V, 12V, 24V	⑤		

■As example, these derating curves have been decided at the below PCB condition.

- FR-4 (Double-sided)
- 203.2mm×76.2mm×1.6mm
- Copper foil thickness : 70μm

● TEPS45F-N

Ambient temperature derating curve at rated input (Reference value)

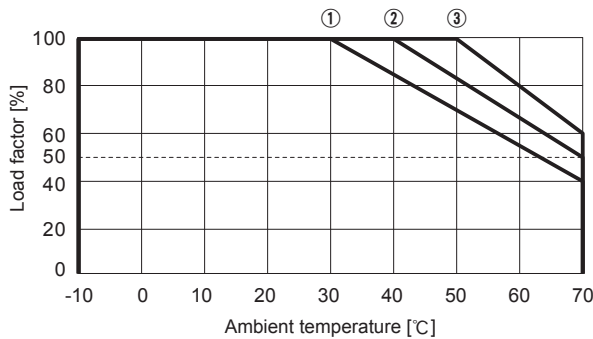

Cooling method	Output voltage	Mounting method	
		A, B, C, D, E, F	
Convection	5V	①	
	12V	①	
	24V	②	
Forced air (0.5m ³ /min)	5V, 12V, 24V	③	

■In case of forced air cooling, ventilation must be uniform.

● TEPS65F-N

Ambient temperature derating curve at rated input (Reference value)

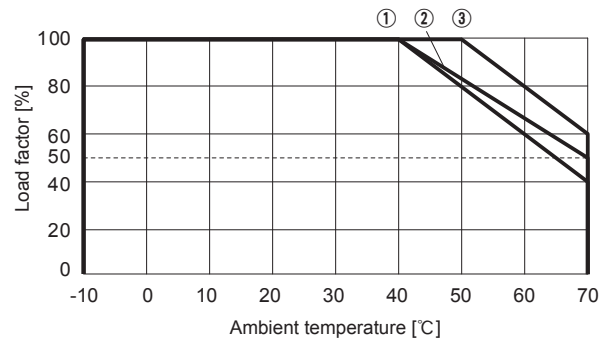

Cooling method	Output voltage	Mounting method	
		A, B, C, D, E, F	
Convection	5V	②	
	12V	①	
	24V	①	
Forced air (0.5m ³ /min)	5V, 12V, 24V	③	

■In case of forced air cooling, ventilation must be uniform.

Instruction Manual

◆ Please see catalog and instructionmanual before you use.

Instruction Manual <https://www.cosel.co.jp/redirect/catalog/en/TEPS/>
 Before using our product <https://en.cosel.co.jp/technical/caution/index.html>

TEPS



NOTICE



Basic Characteristics Data

Model	Circuit method	Switching frequency [kHz]	Input current[A] * 1	Inrush current protection	PCB/Pattern			Series/Parallel operation availability	
					Material	Single sided	Double sided	Series operation	Parallel operation
TEPS10F	Flyback converter	20 to 125	0.21	Thermistor	FR-4		Yes	Yes	No
TEPS20F	Flyback converter	20 to 125	0.40	Thermistor	FR-4		Yes	Yes	No
TEPS45F	Flyback converter	20 to 250	0.90	Thermistor	FR-4		Yes	Yes	No
TEPS65F	Flyback converter	20 to 800	1.25	Thermistor	FR-4		Multilayer	Yes	No

* 1 The value of input current is at ACIN 100V and rated load.