

Main Product Characteristics

$V_{(BR)DSS}$	-30V
$R_{DS(ON)}$	55mΩ (Max)
I_D	-4.4A

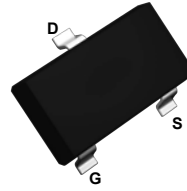

SOT-23

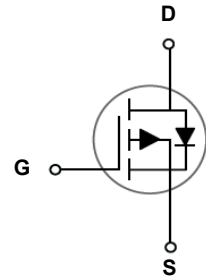

Schematic Diagram

Features and Benefits

- Advanced MOSFET process technology
- Low on-resistance and low gate charge.
- Featuring low switching and drive losses.
- Fast switching and reverse body recovery.
- High ruggedness and robustness.



Description

The GSFC3401 utilizes the latest techniques to achieve ultral low on-resistance and low gate charge and to provide the industry's best-in-class performance. These features make this series products extremely efficient, good temperature characteristics and reliable for use in power management, synchronous rectification, battery protection, load switch and a wide variety of other applications.

Absolute Maximum Ratings ($T_A=25^\circ\text{C}$ unless otherwise specified)

Parameter	Symbol	Max.	Unit
Drain-Source Voltage	V_{DS}	-30	V
Gate-to-Source Voltage	V_{GS}	± 12	V
Continuous Drain Current, @ Steady-State ($T_A=25^\circ\text{C}$) ¹	I_D	-4.4	A
Continuous Drain Current, @ Steady-State ($T_A=100^\circ\text{C}$)		-3.5	A
Pulsed Drain Current ²	I_{DM}	-27	A
Power Dissipation ($T_A=25^\circ\text{C}$)	P_D	1.2	W
Linear Derating Factor ($T_A=25^\circ\text{C}$)		9.6	mW/ $^\circ\text{C}$
Junction-to-Ambient (PCB Mounted, Steady-State) ³	$R_{\theta JA}$	105	$^\circ\text{C/W}$
Operating Junction and Storage Temperature Range	T_J / T_{STG}	-55 to +150	$^\circ\text{C}$

Electrical Characteristics ($T_A=25^\circ\text{C}$ unless otherwise specified)

Parameter	Symbol	Conditions	Min.	Typ.	Max.	Unit
On / Off Characteristics						
Drain-to-Source Breakdown Voltage	$V_{(BR)DSS}$	$V_{GS}=0V, I_D=-250\mu A$	-30	-	-	V
Drain-to-Source Leakage Current	I_{DSS}	$V_{DS}=-30V, V_{GS}=0V$	-	-	-1	μA
		$T_J=125^\circ\text{C}$	-	-	-50	
Gate-to-Source Forward Leakage	I_{GSS}	$V_{GS}=12V$	-	-	100	nA
		$V_{GS}=-12V$	-	-	-100	
Static Drain-to-Source On-Resistance	$R_{DS(on)}$	$V_{GS}=-10V, I_D=-4.4A$	-	45	55	m Ω
		$V_{GS}=-4.5V, I_D=-4A$	-	52	66	
		$V_{GS}=-2.5V, I_D=-2A$	-	68	94	
Gate Threshold Voltage	$V_{GS(th)}$	$V_{DS}=V_{GS}, I_D=-250\mu A$	-0.6	-0.9	-1.4	V
Forward Transconductance	gfs	$V_{DS}=5V, I_D=-3.2A$	-	12	-	S
Dynamic and Switching Characteristic						
Input Capacitance	C_{iss}	$V_{GS}=0V, V_{DS}=-15V$ $F=1\text{MHz}$	-	800	-	pF
Output Capacitance	C_{oss}		-	60	-	
Reverse Transfer Capacitance	C_{rss}		-	58	-	
Total Gate Charge	Q_g	$I_D=-4.4A, V_{DS}=-15V,$ $V_{GS}=-10V$	-	16	-	nC
Gate-to-Source Charge	Q_{gs}		-	2.4	-	
Gate-to-Drain ("Miller") Charge	Q_{gd}		-	2.1	-	
Turn-on Delay Time	$t_{d(on)}$	$V_{GS}=-10V, V_{DS}=-15V,$ $R_L=15\Omega, R_{GEN}=2.6\Omega,$ $I_D=-1A$	-	7	-	nS
Rise Time	t_r		-	1.8	-	
Turn-Off Delay Time	$t_{d(off)}$		-	21	-	
Fall Time	t_f		-	8	-	
Gate Resistance	R_g	$F=1\text{MHz}$	-	4.1	-	Ω
Source-Drain Ratings and Characteristics						
Continuous Source Current (Body Diode)	I_S	MOSFET symbol showing the integral reverse p-n junction diode.	-	-	-4.4	A
Pulsed Source Current (Body Diode)	I_{SM}		-	-	-27	A
Diode Forward Voltage	V_{SD}	$I_S=-4.4A, V_{GS}=0V$	-	-0.8	-1.2	V

Notes

1. Pulse test: Pulse width $\leq 300\mu s$, duty cycle $\leq 2\%$.
2. Repetitive rating; pulse width limited by max. junction temperature.
3. Device mounted on FR-4 PCB, 1 inch x 0.85 inch x 0.062 inch.

Typical Electrical and Thermal Characteristic Curves

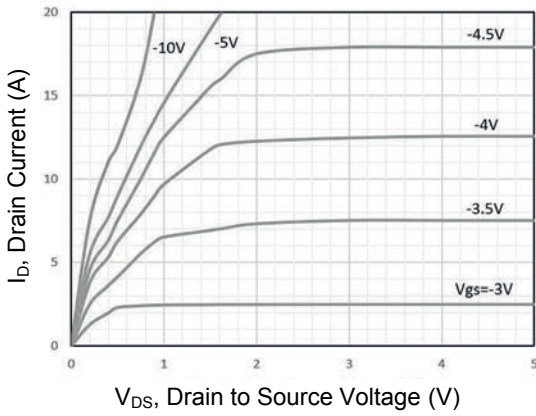

Figure 1. Typical Output Characteristics

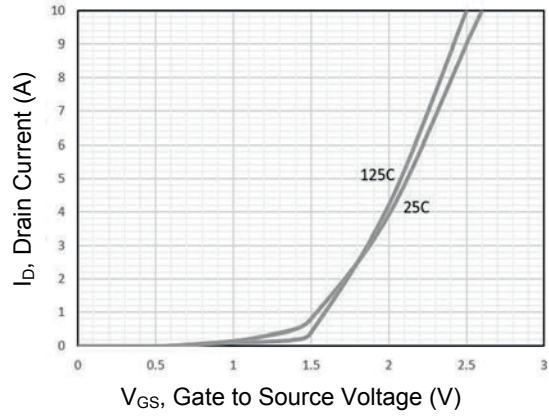

Figure 2. Typical Transfer Characteristics

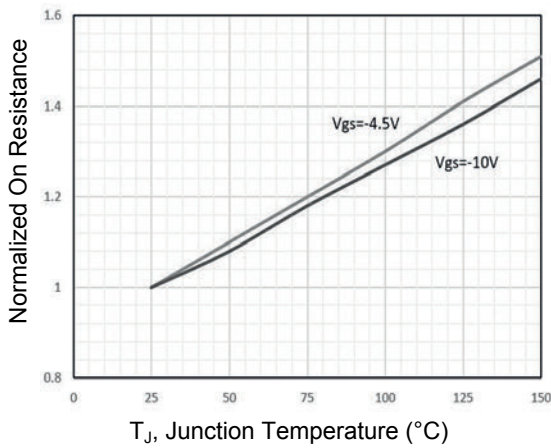

Figure 3. Normalized R_{ON} vs. T_J

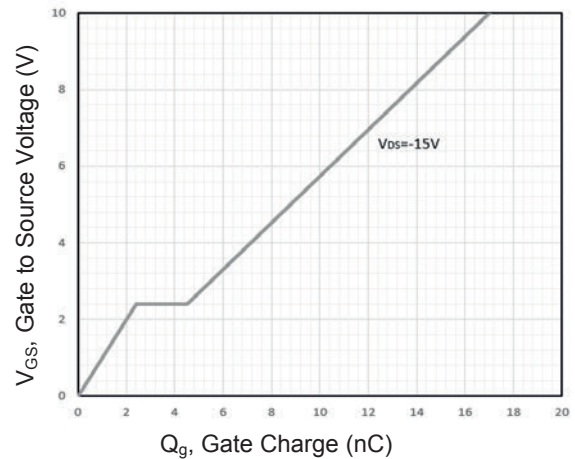

Figure 4. Gate Charge

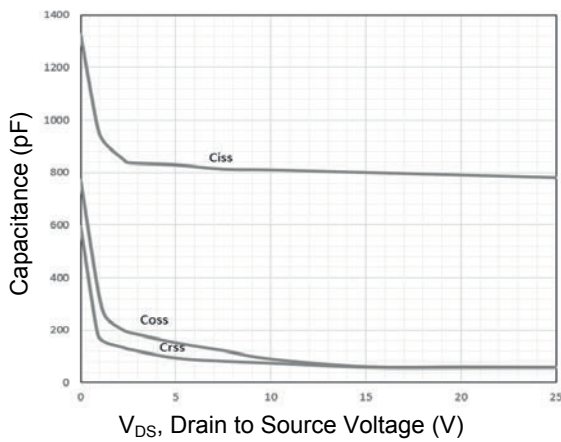

Figure 5. Typical Capacitance Characteristics

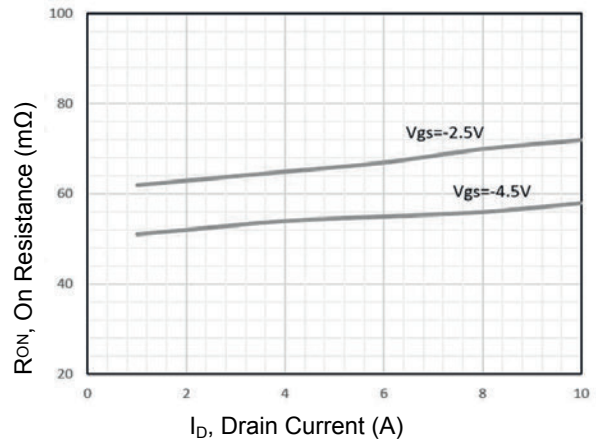
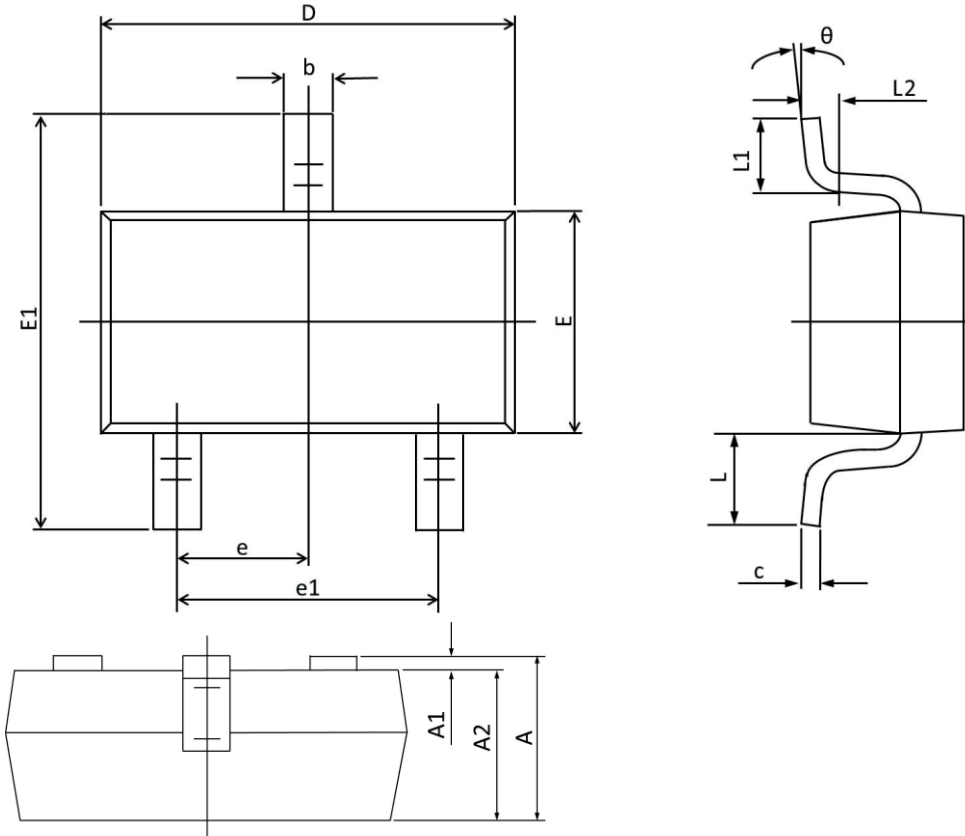

Figure 6. Typical Drain-Source on-Resistance

Package Outline Dimensions (SOT-23)



Symbol	Dimensions In Millimeters		Dimensions In Inches	
	Min	Max	Min	Max
A	0.900	1.150	0.035	0.045
A1	0.000	0.100	0.000	0.004
A2	0.900	1.050	0.035	0.041
b	0.300	0.500	0.012	0.020
c	0.080	0.150	0.003	0.006
D	2.800	3.000	0.110	0.118
E	1.200	1.400	0.047	0.055
E1	2.250	2.550	0.089	0.100
e	0.95 TYP.		0.037 TYP.	
e1	1.800	2.000	0.071	0.079
L	0.55 REF.		0.022 REF.	
L1	0.300	0.500	0.012	0.020
L2	0.25 TYP.		0.01 TYP.	
theta	0°	8°	0°	8°