

MATERIAL:
 HOUSING : PBT,UL94V-0,BLACK.
 TERMINALS BRACKET: PBT,UL94V-0,BLACK.
 SHIELD: C2680,T=0.20MM,NICKEL PLATING ON ALL AREA.
 TERMINAL: PHOSPHOR BRONZE C5210,T=0.35MM,
 6U" GOLD PLATING ON CONTACT AREA.

MECHANICAL:
 DURABILITY : 750 CYCLES MIN.
 MATING FORCE : 23N MAX.
 OPERATING TEMPERATURE: -40°C~+85°C.
 STORAGE TEMPERATURE: -40°C~+85°C.
 ALL CRITICAL DIMENSIONS WITH "*"

TOP VIEW

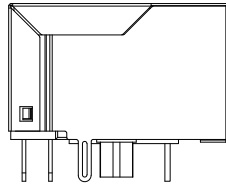

LEFT SIDE VIEW

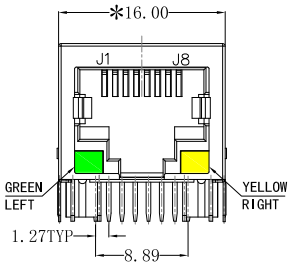

FRONT VIEW

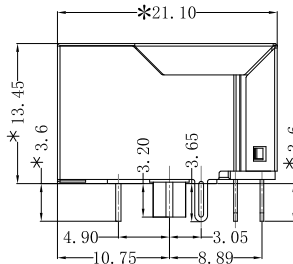

RIGHT SIDE VIEW

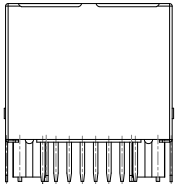

BACK VIEW

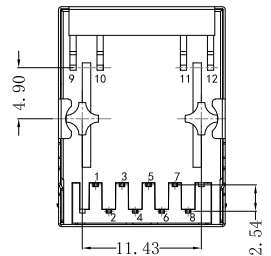

BOTTOM VIEW

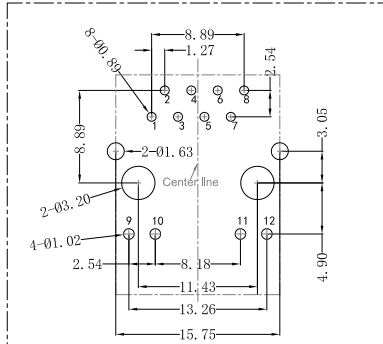

RECOMMENDED PCB LAYOUT VIEWED FROM COMPONENT SIDE

Ordering Information

HC 61 * * ** A- M907 - A

Type	LED Color	EMI	Ports	产品序号
□ 带灯 (带灯)	□ 绿 (绿)	□ 无 (无)	□ 1-10	
□ 不带灯 (不带灯)	□ 红 (红)	□ 有 (有)	□ 1-12	
□ 带灯 (带灯)	□ 蓝 (蓝)	□ 有 (有)	□ 1-12	
□ 带灯 (带灯)	□ 黄 (黄)	□ 有 (有)	□ 1-12	
			□ 1-12	

			GENEAL TOLERANCE		制图 DRAWING		深圳市华灿天禄电子有限公司 ShenzhenhuacantianluELECTRONICS CO.,LTD			
			DIM	TOL	审核 CHECK					
			X.X	±0.30	批准 APPROVAL		产品名称 TITLE	网络插座 (插件 带灯无弹 TAB-DOWN 1X1 100BASE)	版本 REV.	A
			X.XX	±0.20	比例 SCALE		产品料号 PART NO.	HC612601A-M907-A	单位 UNITS	mm
			X.XXX	±0.10	投影 Projection		材料 MATERIAL		页次 SHEET	1/4
序号 No.	变更内容 MODIFY CONTENT	日期 MODIFY DATE	Angle ±3.0°							

RECOMMENDED PANEL CUTOUT (REFERENCE ONLY) :

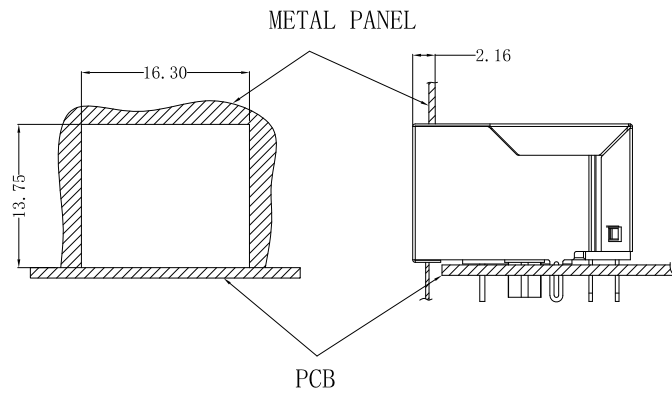

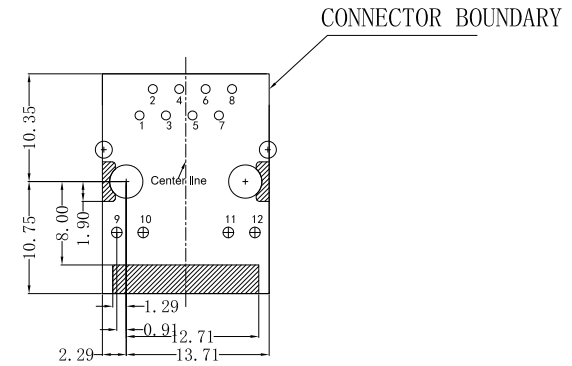

UNIT: MM / INCH
 TOLERANCES: $\pm 0.10 / 0.004$
 REFERENCE ONLY

KEEP-OUT AREA (COMPONENT SIDE VIEW) :



PLUG-IN SIDE

UNIT: MM / INCH
 TOLERANCES: $\pm 0.10 / 0.004$

			GENERAL TOLERANCE	制图 DRAWING	 深圳市华灿天禄电子有限公司 ShenzhenhuacantianluELECTRONICS CO., LTD				
			DIM TOL	审核 CHECK					
			X.X ± 0.30	批准 APPROVAL		产品名称 TITLE	网络插座 (插件 带灯无弹 TAB-DOWN 1X1 100BASE)	版本 REV.	A
1	初版发行		X.XX ± 0.20	比例 SCALE		产品料号 PART NO.	HC612601A-M907-A	单位 UNITS	mm
序号 No.	变更内容 MODIFY CONTENT	日期 MODIFY DATE	X.XXX ± 0.10	投影 Projection		材料 MATERIAL		页次 SHEET	2/4
			Angle $\pm 3.0^\circ$						

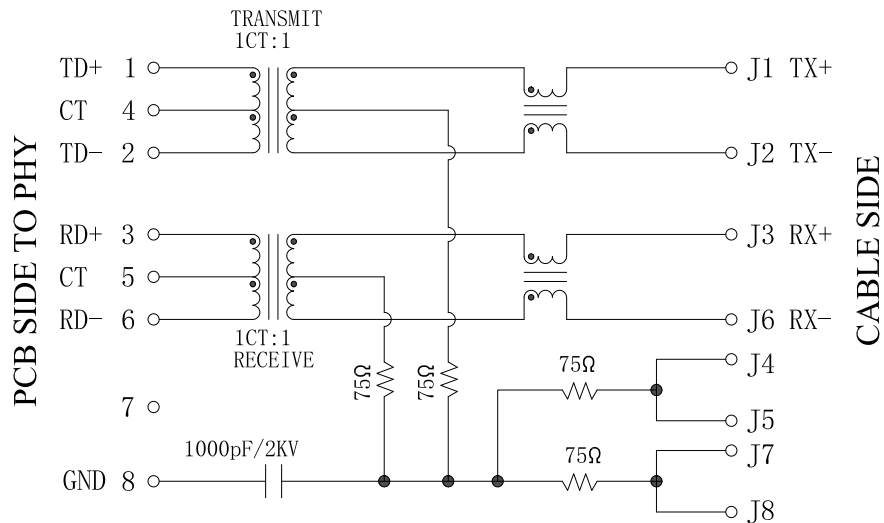

Electrical:

- Turn ratio: 1~2: J1~J2=1CT:1CT(±2%).
3~6: J3~J6=1CT:1CT(±2%).
- OCL: 350uH Min. at 100KHz 100mV 8mA DC.
- Insertion Loss: -1.0 dB Max 1~100MHz.
- Return loss: -20dB Min 1~10MHz;
-16dB Min 10~30MHz.
-12dB Min 30~60MHz.
-10dB Min 60~80MHz.
- Cross talk: -40dB Min 1~30MHz;
-35dB Min 30~60MHz;
-30dB Min 60~100MHz;
- CMR: -30dB Min 1~100MHz;
- Hi-Pot: 1500V AC & 2250V DC
6S 1mA PRI TO SEC

LED Specification

Standard LED Color	LED Wavelength	Foward(A)	Foward(V)
Green	568nm	20mA	1.85-2.45V
Yellow	585nm	20mA	1.7-2.2V

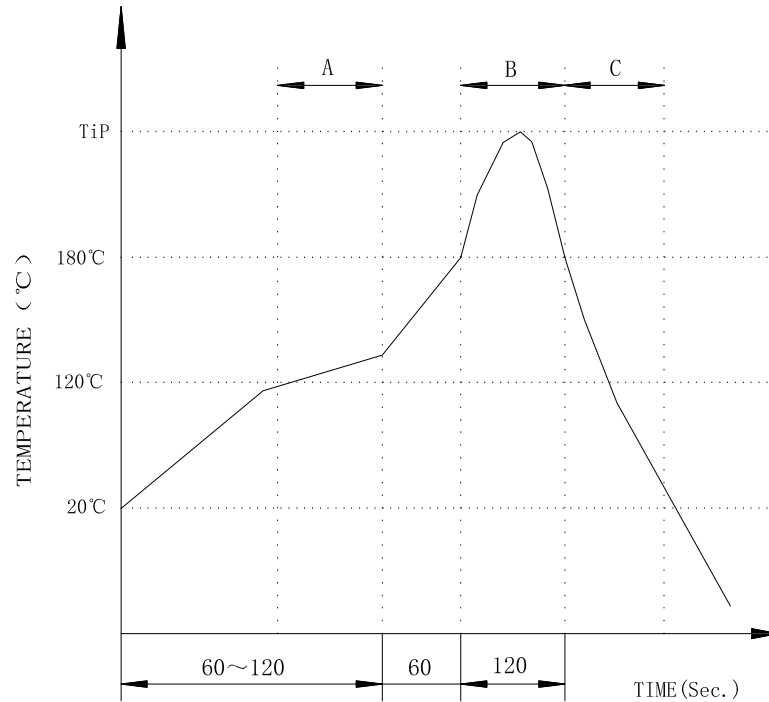

			GENEAL TOLERANCE	制图 DRAWING	深圳市华灿天禄电子有限公司 ShenzhenhuacantianluELECTRONICS CO., LTD			
			DIM TOL	审核 CHECK				
			X.X ±0.30	批准 APPROVAL	产品名称 TITLE	网络插座 (插件 带灯无弹 TAB-DOWN 1X1 100BASE)	版本 REV.	A
1 初版发行			X.XX ±0.20	比例 SCALE	产品料号 PART NO.	HC612601A-M907-A	单位 UNITS	mm
序号 No.	变更内容 MODIFY CONTENT	日期 MODIFY DATE	X.XXX ±0.10	投影 Projection	材料 MATERIAL		页次 SHEET	3/4
			Angle ±3.0°					

PROFILE OF WAVE SOLDER



A.Preheating B.Soldering C.Gradual Cooling
 Tip temperature:260±5°C.
 Tip temperature time:5Sec Max.
 Tip melting point of Sn96.5/Ag3/Cu0.5:217°C.

Remarks: after wave soldering, the plastic positioning columns of the product which under the PCB will be slightly melted, but it won't affect its function.

			GENE RL TOLERANCE	制 图 DRAWING	 深圳市华灿天禄电子有限公司 ShenzhenhuacantianluELECTRONICS CO.,LTD				
			DIM TOL	审 核 CHECK		产 品 名 称 TITLE	网 络 插 座 (插 件 带 灯 无 弹 TAB-DOWN 1X1 100BASE)	版 本 REV.	A
			X.X ±0.30	批 准 APPROVAL		产 品 料 号 PART NO.	HC612601A-M907-A	单 位 UNITS	mm
1	初版发行		X.XX ±0.20	比 例 SCALE				页 次 SHEET	4/4
序号 No.	变 更 内 容 MODIFY CONTENT	日 期 MODIFY DATE	X.XXX ±0.10	投 影 Projection		材 料 MATERIAL			
			Angle ±3.0°						