

Three-Phase Bridge, Brake, Soft Start, and Solenoid Power Module



MSCSM120XM50CTYZBNMG

Product Overview

The MSCSM120XM50CTYZBNMG device is a three-phase bridge, brake, soft start, and solenoid power module. The following figures show the electrical diagram and pinout location of the device.

Figure 1. Electrical Diagram

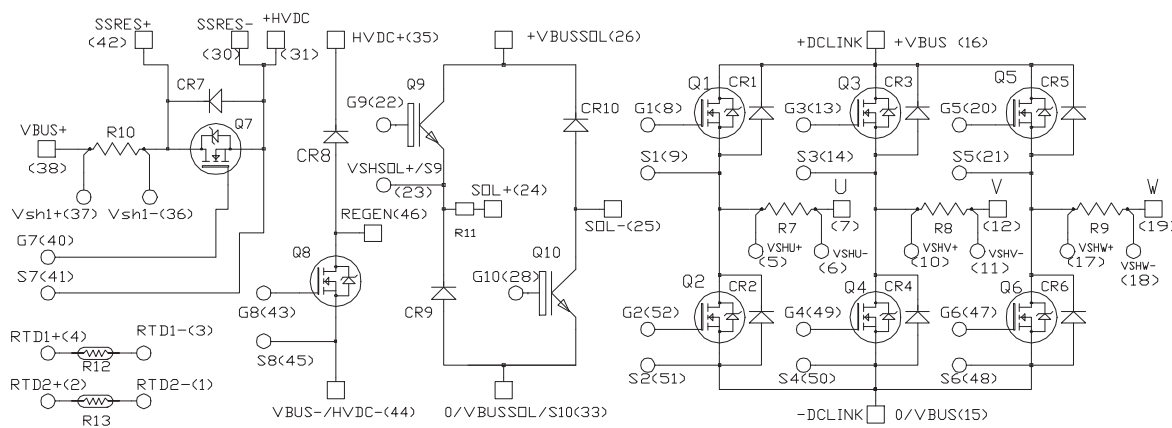
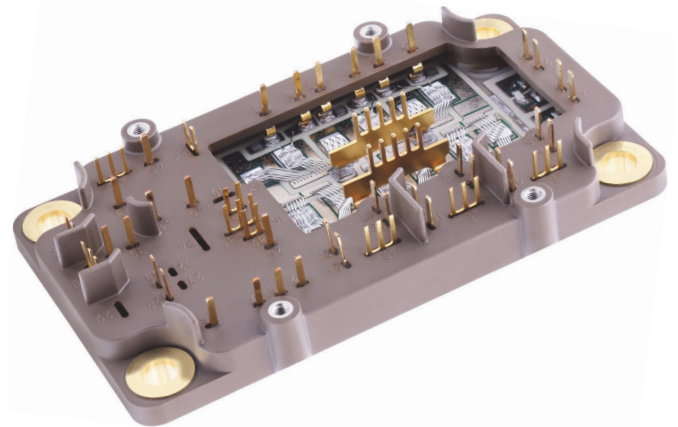
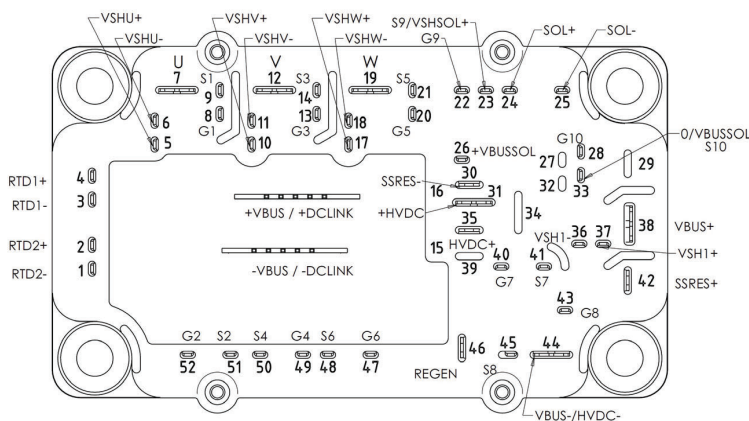

Figure 2. Pinout Location



Note: All ratings are at $T_j = 25^\circ\text{C}$, unless otherwise specified.



These devices are sensitive to electrostatic discharge. Proper handling procedures must be followed.

Features

The MSCSM120XM50CTYZBNMG device has the following key features:

- Silicon Carbide (SiC) MOSFET
- SiC Schottky Diode
- Low stray inductance
- Lead frames for power connections
- Si₃N₄ substrate for improved thermal performance
- AlSiC base plate for extended reliability and reduced weight
- Extended storage temperature range
- Internal thermistor for temperature monitoring

Benefits

The MSCSM120XM50CTYZBNMG device has the following benefits:

- Stable temperature behavior
- Very rugged
- Solderable terminals for easy PCB mounting
- Direct mounting to heatsink (isolated package)
- Low junction-to-case thermal resistance
- RoHS Compliant

Application

The MSCSM120XM50CTYZBNMG device has the following applications:

- Hybrid Power Device (HPD) for Electro-Mechanical Actuator (EMA) and Electro-Hydrostatic Actuator (EHA) systems
- High reliability Power Core Module (PCM)
- Modular power module for Power Drive Electronic (PDE)

1. Electrical Specification

The following sections describe the electrical specifications of the MSCSM120XM50CTYZBNMG device.

1.1 Q1 to Q6 and Q8 SiC MOSFETs (Per SiC MOSFET): Three-Phase Bridge and Brake

The following table lists the absolute maximum ratings (per SiC MOSFET) of the Q1 to Q6 and Q8 SiC MOSFETs.

Table 1-1. Absolute Maximum Ratings: Q1 to Q6 and Q8 SiC MOSFETs

Symbol	Parameter	Maximum Ratings	Unit
V_{DSS}	Drain-source voltage	1200	V
I_D	Continuous drain current	$T_C = 25\text{ }^\circ\text{C}$	49 ¹
		$T_C = 80\text{ }^\circ\text{C}$	39 ¹
I_{DM}	Pulsed drain current	94	
V_{GS}	Gate-source voltage	-10/23	V
$R_{DS(on)}$	Drain-source ON resistance	50	m Ω
P_D	Power dissipation	$T_C = 25\text{ }^\circ\text{C}$	196

Note: Specification of Q1 to Q6 SiC MOSFET device, but output current must be limited due to the shunt resistor (for more information, see [1.7. Electrical Shunt Characteristics](#)).

The following table lists the electrical characteristics (per SiC MOSFET) of the Q1 to Q6 and Q8 SiC MOSFETs.

Table 1-2. Electrical Characteristics: Q1 to Q6 and Q8 SiC MOSFETs

Symbol	Characteristic	Test Conditions	Min.	Typ.	Max.	Unit
I_{DSS}	Zero gate voltage drain current	$V_{GS} = 0V$; $V_{DS} = 1200V$	—	10	100	μA
$R_{DS(on)}$	Drain-source ON resistance	$V_{GS} = 20V$ $I_D = 40A$	$T_J = 25\text{ }^\circ\text{C}$	—	40	50
			$T_J = 175\text{ }^\circ\text{C}$	—	64	—
$V_{GS(th)}$	Gate threshold voltage	$V_{GS} = V_{DS}$; $I_D = 2\text{ mA}$	1.8	2.7	—	V
I_{GSS}	Gate-source leakage current	$V_{GS} = 20V$; $V_{DS} = 0V$	—	—	150	nA

The following table lists the dynamic characteristics (per SiC MOSFET) of the Q1 to Q6 and Q8 SiC MOSFETs.

Table 1-3. Dynamic Characteristics: Q1 to Q6 and Q8 SiC MOSFETs

Symbol	Characteristic	Test Conditions	Min.	Typ.	Max.	Unit
C_{iss}	Input capacitance	$V_{GS} = 0V$	—	1990	—	pF
C_{oss}	Output capacitance	$V_{DS} = 1000V$	—	156	—	
C_{rss}	Reverse transfer capacitance	$f = 1\text{ MHz}$	—	17	—	
Q_g	Total gate charge	$V_{GS} = -5V/20V$	—	137	—	nC
Q_{gs}	Gate-source charge	$V_{Bus} = 800V$	—	29	—	
Q_{gd}	Gate-drain charge	$I_D = 40A$	—	31	—	
$T_{d(on)}$	Turn-on delay time	$V_{GS} = -5V/20V$	—	30	—	ns
T_r	Rise time	$V_{Bus} = 600V$				
$T_{d(off)}$	Turn-off delay time	$I_D = 40A$				
T_f	Fall time	$R_{GON} = 10\Omega$ $R_{GOFF} = 5.8\Omega$				
E_{on}	Turn-on energy	$V_{GS} = -5V/20V$	—	0.8	—	mJ
E_{off}	Turn-off energy	$V_{Bus} = 600V$ $I_D = 40A$ $R_{GON} = 10\Omega$ $R_{GOFF} = 5.8\Omega$				
R_{Gint}	Internal gate resistance		—	6.2	—	Ω
R_{thJC}	Junction-to-case thermal resistance		—	—	0.76	$^{\circ}C/W$

The following table lists the body diode ratings and characteristics (per SiC MOSFET) of the Q1 to Q6 and Q8 SiC MOSFETs.

Table 1-4. Body Diode Ratings and Characteristics: Q1 to Q6 and Q8 SiC MOSFETs

Symbol	Characteristic	Test Conditions	Min.	Typ.	Max.	Unit
V_{SD}	Diode forward voltage	$V_{GS} = 0V; I_{SD} = 40A$	—	3.9	—	V
t_{rr}	Reverse recovery time	$I_{SD} = 40A$	—	31	—	ns
Q_{rr}	Reverse recovery charge	$V_{GS} = -5V$	—	610	—	nC
I_{rr}	Reverse recovery current	$V_R = 800V$ $di_f/dt = 1800\text{ A}/\mu\text{s}$	—	40	—	A

1.2 CR1 to CR6 SiC Diodes (Per SiC Diode): Three-Phase Bridge

The following table lists the ratings and characteristics (per SiC diode) of the CR1 to CR6 SiC diodes.

Table 1-5. Ratings and Characteristics: CR1 to CR6 SiC Diodes

Symbol	Characteristic	Test Conditions	Min.	Typ.	Max.	Unit	
V_{RRM}	Peak repetitive reverse voltage		—	—	1200	V	
I_{RM}	Reverse leakage current	$V_R = 1200V$	$T_J = 25\text{ }^\circ\text{C}$	—	10	200	μA
			$T_J = 175\text{ }^\circ\text{C}$	—	50	—	
I_F	DC forward current			15	—	A	
V_F	Diode forward voltage	$I_F = 15A$	$T_J = 25\text{ }^\circ\text{C}$	—	1.5	1.8	V
			$T_J = 175\text{ }^\circ\text{C}$	—	2	—	
Q_C	Total capacitive charge	$V_R = 600V$	—	73	—	nC	
C	Total capacitance	$f = 1\text{ MHz}, V_R = 400V$	—	80	—	pF	
		$f = 1\text{ MHz}, V_R = 800V$	—	59	—		
R_{thJC}	Junction-to-case thermal resistance		—	—	1.94	$^\circ\text{C/W}$	

1.3 Q7 SiC MOSFET: Soft Start

The following table lists the absolute maximum ratings of the Q7 SiC MOSFET.

Table 1-6. Absolute Maximum Ratings: Q7 SiC MOSFET

Symbol	Parameter	Maximum Ratings	Unit	
V_{DSS}	Drain-source voltage	1200	V	
I_D	Continuous drain current	$T_C = 25\text{ }^\circ\text{C}$	80	A
		$T_C = 80\text{ }^\circ\text{C}$	63	
I_{DM}	Pulsed drain current	160		
V_{GS}	Gate-source voltage	-10/23	V	
$R_{DS(on)}$	Drain-source ON resistance	31	m Ω	
P_D	Power dissipation	$T_C = 25\text{ }^\circ\text{C}$	315	W

The following table lists the electrical characteristics of the Q7 SiC MOSFET.

Table 1-7. Electrical Characteristics: Q7 SiC MOSFET

Symbol	Characteristic	Test Conditions	Min.	Typ.	Max.	Unit	
I_{DSS}	Zero gate voltage drain current	$V_{GS} = 0V$ $V_{DS} = 1200V$	—	10	100	μA	
$R_{DS(on)}$	Drain-source ON resistance	$V_{GS} = 20V$ $I_D = 40A$	$T_J = 25\text{ }^\circ\text{C}$	—	25	31	m Ω
			$T_J = 175\text{ }^\circ\text{C}$	—	40	—	
$V_{GS(th)}$	Gate threshold voltage	$V_{GS} = V_{DS}$ $I_D = 3\text{ mA}$	1.8	2.8	—	V	
I_{GSS}	Gate-source leakage current	$V_{GS} = 20V$ $V_{DS} = 0V$	—	—	150	nA	

The following table lists the dynamic characteristics of the Q7 SiC MOSFET.

Table 1-8. Dynamic Characteristics: Q7 SiC MOSFET

Symbol	Characteristic	Test Conditions	Min.	Typ.	Max.	Unit
C_{iss}	Input capacitance	$V_{GS} = 0V$	—	3020	—	pF
C_{oss}	Output capacitance	$V_{DS} = 1000V$	—	270	—	
C_{rss}	Reverse transfer capacitance	$f = 1\text{ MHz}$	—	25	—	
Q_g	Total gate charge	$V_{GS} = -5/20V$	—	232	—	nC
Q_{gs}	Gate-source charge	$V_{Bus} = 800V$	—	41	—	
Q_{gd}	Gate-drain charge	$I_D = 40A$	—	50	—	
$T_{d(on)}$	Turn-on delay time	$V_{GS} = -5/20V$	—	30	—	ns
T_r	Rise time	$V_{Bus} = 600V$				
$T_{d(off)}$	Turn-off delay time	$I_D = 50A$				
T_f	Fall time	$R_{GON} = 8\Omega$ $R_{GOFF} = 4.7\Omega$				
E_{on}	Turn-on energy	$V_{GS} = -5/20V$	—	1	—	mj
E_{off}	Turn-off energy	$V_{Bus} = 600V$ $I_D = 50A$ $R_{GON} = 8\Omega$ $R_{GOFF} = 4.7\Omega$				
R_{Gint}	Internal gate resistance		—	5.88	—	Ω
R_{thJC}	Junction-to-case thermal resistance		—	—	0.48	$^{\circ}C/W$

The following table lists the body diode ratings and characteristics of the Q7 SiC MOSFET.

Table 1-9. Body Diode Ratings and Characteristics: Q7 SiC MOSFET

Symbol	Characteristic	Test Conditions	Min.	Typ.	Max.	Unit
V_{SD}	Diode forward voltage	$V_{GS} = 0V; I_{SD} = 40A$	—	4	—	V
		$V_{GS} = -5V; I_{SD} = 40A$	—	4.2	—	
t_{rr}	Reverse recovery time	$I_{SD} = 40A$	—	90	—	ns
Q_{rr}	Reverse recovery charge	$V_{GS} = -5V$	—	550	—	nC
I_{rr}	Reverse recovery current	$V_R = 800V$ $di_f/dt = 1000\text{ A}/\mu\text{s}$	—	13.5	—	A

1.4 CR7 and CR8 SiC Diodes (Per SiC diode): Brake and Soft Start

The following table lists the ratings and characteristics (per SiC diode) of the CR7 and CR8 SiC diodes.

Table 1-10. Ratings and Characteristics: CR7 and CR8 SiC Diodes

Symbol	Characteristic	Test Conditions	Min.	Typ.	Max.	Unit	
V_{RRM}	Peak repetitive reverse voltage		—	—	1200	V	
I_{RM}	Reverse leakage current	$V_R = 1200V$	$T_J = 25\text{ }^\circ\text{C}$	—	10	200	μA
			$T_J = 175\text{ }^\circ\text{C}$	—	150	—	
I_F	DC forward current	$T_J = 175\text{ }^\circ\text{C}$	—	30	—	A	
V_F	Diode forward voltage	$I_F = 30A$	$T_J = 25\text{ }^\circ\text{C}$	—	1.5	1.8	V
			$T_J = 175\text{ }^\circ\text{C}$	—	2.1	—	
Q_C	Total capacitive charge	$V_R = 600V$	—	130	—	nC	
C	Total capacitance	$f = 1\text{ MHz}, V_R = 400V$	—	141	—	pF	
		$f = 1\text{ MHz}, V_R = 800V$	—	105	—		
R_{thJC}	Junction-to-case thermal resistance		—	—	1.125	$^\circ\text{C/W}$	

1.5 Q9 and Q10 IGBTs (Per IGBT): Solenoid

The following table lists the absolute maximum ratings (per IGBT) of the Q9 and Q10 IGBTs.

Table 1-11. Absolute Maximum Ratings: Q9 and Q10 IGBTs

Symbol	Parameter	Maximum Ratings	Unit	
V_{CES}	Collector-emitter voltage	1200	V	
I_C	Continuous collector current	$T_C = 25\text{ }^\circ\text{C}$	27	A
		$T_C = 80\text{ }^\circ\text{C}$	15	
I_{CM}	Pulsed collector current	$T_C = 25\text{ }^\circ\text{C}$	30	
V_{GE}	Gate-emitter voltage	± 20	V	
P_D	Power dissipation	$T_C = 25\text{ }^\circ\text{C}$	80	W

The following table lists the electrical characteristics (per IGBT) of the Q9 and Q10 IGBTs.

Table 1-12. Electrical Characteristics: Q9 and Q10 IGBTs

Symbol	Characteristic	Test Conditions	Min.	Typ.	Max.	Unit	
I_{CES}	Zero gate voltage collector current	$V_{GE} = 0V$ $V_{CE} = 1200V$	—	—	100	μA	
$V_{CE(sat)}$	Collector emitter saturation voltage	$V_{GE} = 15V$ $I_C = 8A$	$T_J = 25\text{ }^\circ\text{C}$	1.6	1.85	2.1	V
			$T_J = 150\text{ }^\circ\text{C}$	—	2.25	—	
$V_{GE(th)}$	Gate threshold voltage	$V_{GE} = V_{CE}$ $I_C = 0.3\text{ mA}$	5.3	5.8	6.3		
I_{GES}	Gate-emitter leakage current	$V_{GE} = 15V$ $V_{CE} = 0V$	—	—	150	nA	
C_{ies}	Input capacitance	$V_{GE} = 0V$	—	490	—	pF	
C_{res}	Reverse transfer capacitance	$V_{CE} = 25V$ $f = 1\text{ MHz}$	—	30	—		
R_{thJC}	Junction-to-case thermal resistance		—	—	1.85	$^\circ\text{C/W}$	

1.6 CR9 and CR10 SiC Diodes (Per SiC diode): Solenoid

The following table lists the ratings and characteristics (per SiC diode) of the CR9 and CR10 SiC diodes.

Table 1-13. Ratings and Characteristics: CR9 and CR10 SiC Diodes

Symbol	Characteristic	Test Conditions	Min.	Typ.	Max.	Unit
V_{RRM}	Peak repetitive reverse voltage		—	—	1200	V
I_{RM}	Reverse leakage current	$V_R = 1200V$ $T_J = 25\text{ }^\circ\text{C}$	—	15	200	μA
		$T_J = 175\text{ }^\circ\text{C}$	—	50	—	
I_F	DC forward current	$T_J = 175\text{ }^\circ\text{C}$ $T_C = 80\text{ }^\circ\text{C}$	—	10	—	A
V_F	Diode forward voltage	$I_F = 10A$ $T_J = 25\text{ }^\circ\text{C}$	—	1.5	1.8	V
		$T_J = 175\text{ }^\circ\text{C}$	—	2.1	—	
Q_C	Total capacitive charge	$V_R = 600V$	—	48	—	nC
C	Total capacitance	$f = 1\text{ MHz}, V_R = 400V$	—	55	—	pF
		$f = 1\text{ MHz}, V_R = 800V$	—	43	—	
R_{thJC}	Junction-to-case thermal resistance		—	—	3	$^\circ\text{C}/\text{W}$

1.7 Electrical Shunt Characteristics

The following tables list the electrical shunt characteristics of the MSCSM120XM50CTYZBNMG device.

Table 1-14. Shunt (R7 to R9)

Symbol	Characteristic	Min.	Typ.	Max.	Unit
R_i	Resistance value	—	5	—	$\text{m}\Omega$
T_{Ri}	Tolerance	—	1	1.5	%
P_{Ri}	Load capacity	—	—	3	W
I_{Ri}	Current capacity	—	—	24	A

Table 1-15. Shunt (R10)

Symbol	Characteristic	Min.	Typ.	Max.	Unit
R_i	Resistance value	—	0.5	—	$\text{m}\Omega$
T_{Ri}	Tolerance	—	1	1.5	%
P_{Ri}	Load capacity	—	—	5	W
I_{Ri}	Current capacity	—	—	100	A

Table 1-16. Shunt (R11)

Symbol	Characteristic	Min.	Typ.	Max.	Unit
R_i	Resistance value	—	15	—	$\text{m}\Omega$
$RSoli$	Resistance value with SOL+ connector ¹	—	15.25	—	
T_{Ri}	Tolerance	—	1	1.5	%
P_{Ri}	Load capacity	—	—	3	W
I_{Ri}	Current capacity	—	—	14	A

Note:

- Value that integrates the resistivity of the SOL+ connector considering the user PCB mounted on the spacers and soldered on the power module in accordance with IPC A610, class 3.

1.8 Temperature Sensor PTC

The following table lists the temperature sensor PTC of the MSCSM120XM50CTYZBNMG device.

Table 1-17. Temperature Sensor PTC

Symbol	Characteristic	Typ.	Unit
R ₀	Resistance at 0 °C	1000	Ω
A	—	3.9083 × 10 ⁻³	°C ⁻¹
B	—	-5.775 × 10 ⁻⁷	°C ⁻²
C	—	-4.183 × 10 ⁻¹²	°C ⁻⁴
ΔT	—	±(0.3 + 0.005 × T)	°C

For temperature range of 0 °C up to 175 °C, $R_T = R_0 (1 + A \times T + B \times T^2)$

For temperature range of -55 °C up to 0 °C, $R_T = R_0 (1 + A \times T + B \times T^2 + C (T - 100) T^3)$

Where:

T: Temperature in °C

R_T: Thermistor value at T

Note: For more information, see [APT0406—Using NTC Temperature Sensor Integrated into Power Module](#).

1.9 Thermal and Package Characteristics

The following table lists the thermal and package characteristics of the MSCSM120XM50CTYZBNMG device.

Table 1-18. Thermal and Package Characteristics

Symbol	Characteristic	Min.	Max.	Unit		
V _{ISOL}	RMS isolation voltage, any terminal to case, t = 1 min, at 1 bar	4000	—	V		
V _{ISOLPTC}	RMS isolation voltage, PTC to any other electrical terminals, t = 1 min at 1 bar, 50/60 Hz	1500	—			
T _J	Operating junction temperature range	-55	175	°C		
T _{JOP}	Recommended junction temperature under switching conditions	-55	T _{Jmax} -25			
T _{STG}	Storage temperature range	-60	125			
T _C	Operating case temperature	-55	125			
Torque	Mounting torque	Insert	M2.5	—	0.3	N.m
		To heatsink	M6	3	5	
Wt	Package weight	—	150	g		

1.10 Typical SiC MOSFET Performance Curve (Q1 to Q6 and Q8)

The following figures show the performance curves of the Q1 to Q6 and Q8 SiC MOSFETs.

Figure 1-1. Maximum Thermal Impedance

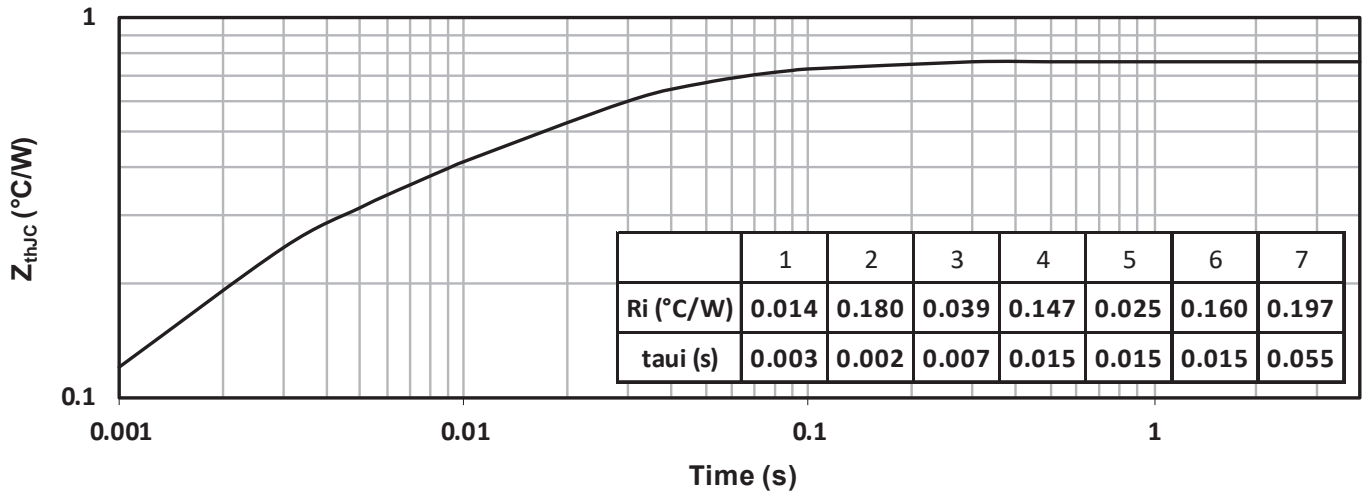

Figure 1-2. Output Characteristics, $T_J = 25\text{ }^\circ\text{C}$

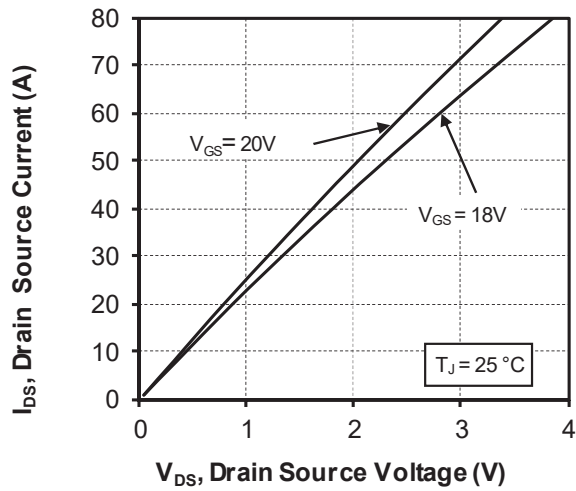

Figure 1-3. Output Characteristics, $T_J = 175\text{ }^\circ\text{C}$

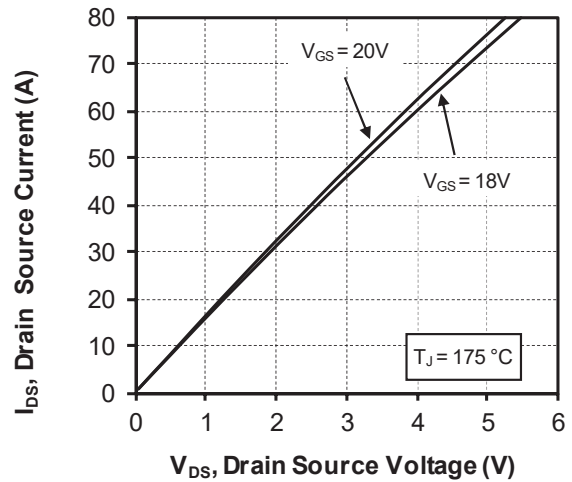

Figure 1-4. Normalized $R_{DS(on)}$ vs. Temperature

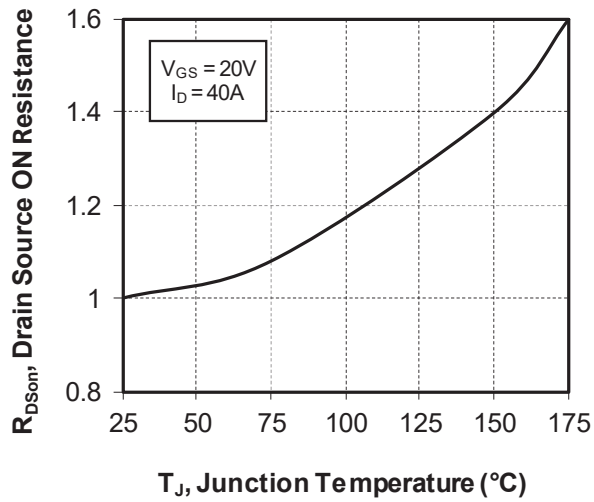

Figure 1-5. Transfer Characteristics

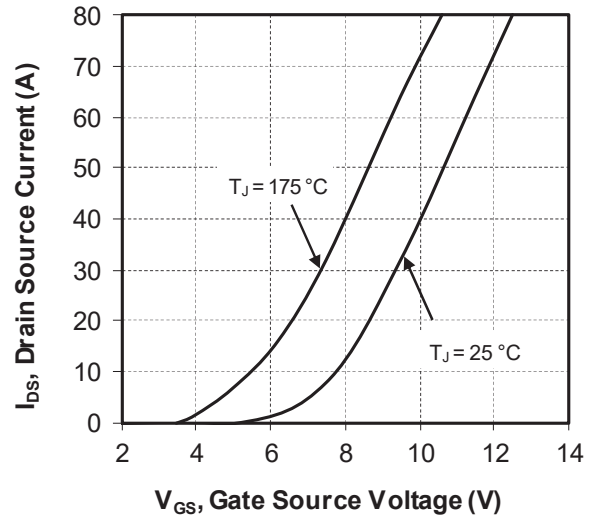

Figure 1-6. Switching Energy vs. R_g

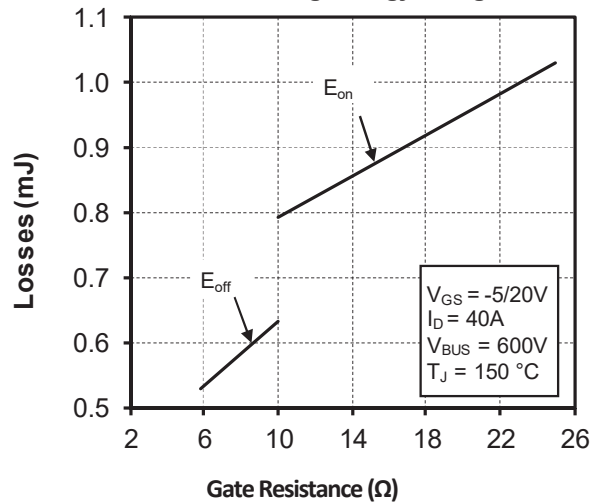

Figure 1-7. Switching Energy vs. Current

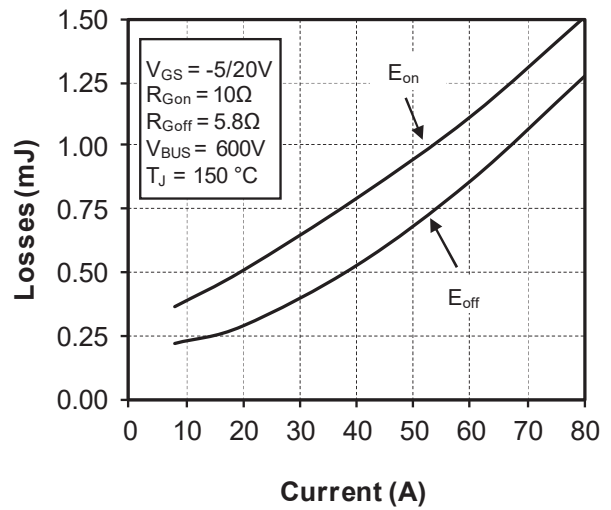

Figure 1-8. Capacitance vs. Drain Source Voltage

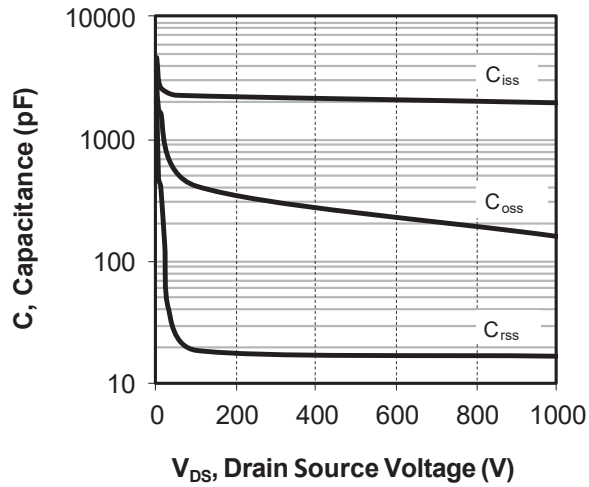

Figure 1-9. Gate Charge vs. Gate Source Voltage

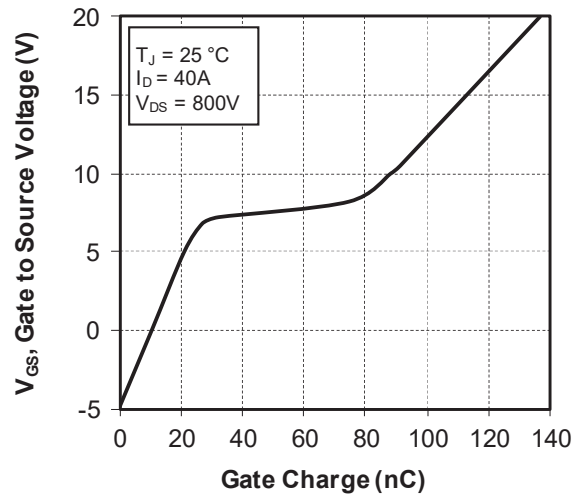

Figure 1-10. Body Diode Characteristics, $T_J = 25^\circ\text{C}$

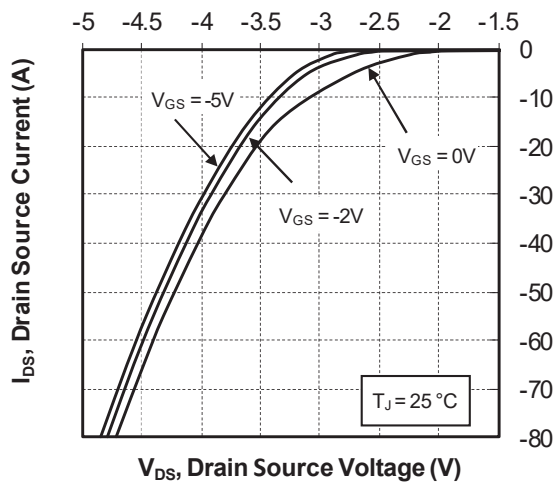

Figure 1-11. 3rd Quadrant Characteristics, $T_J = 25^\circ\text{C}$

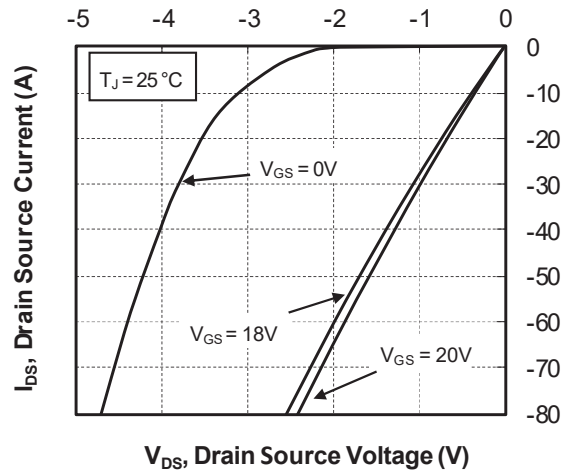

Figure 1-12. Body Diode Characteristics, $T_J = 175\text{ }^\circ\text{C}$

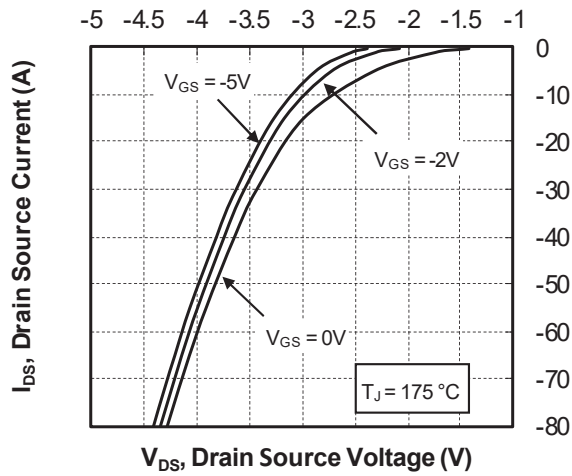

Figure 1-13. 3rd Quadrant Characteristics, $T_J = 175\text{ }^\circ\text{C}$

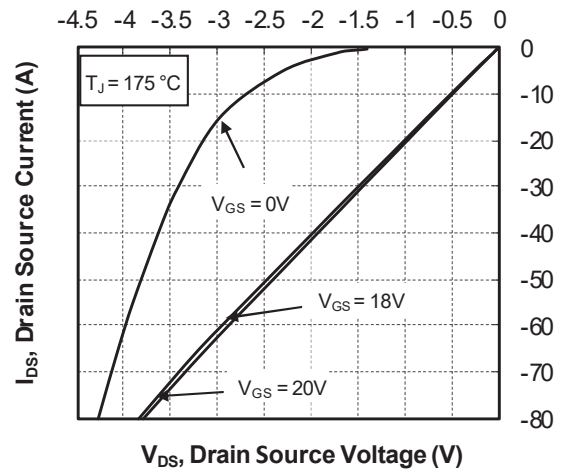
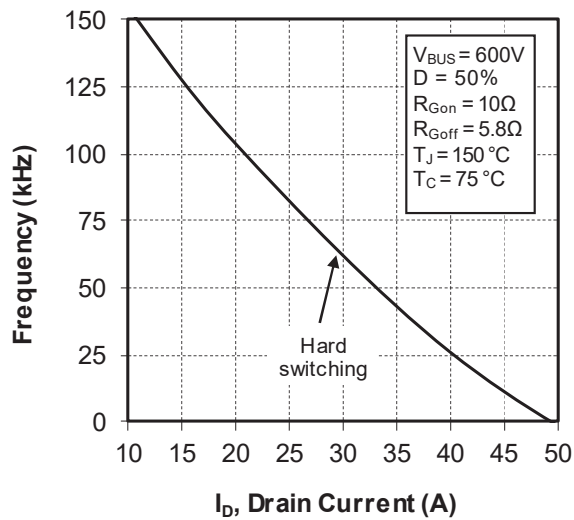

Figure 1-14. Operating Frequency vs. Drain Current



1.11 Typical SiC Diode Performance Curve (CR1 to CR6)

The following figures show the performance curves of the CR1 to CR6 SiC diodes.

Figure 1-15. Maximum Thermal Impedance

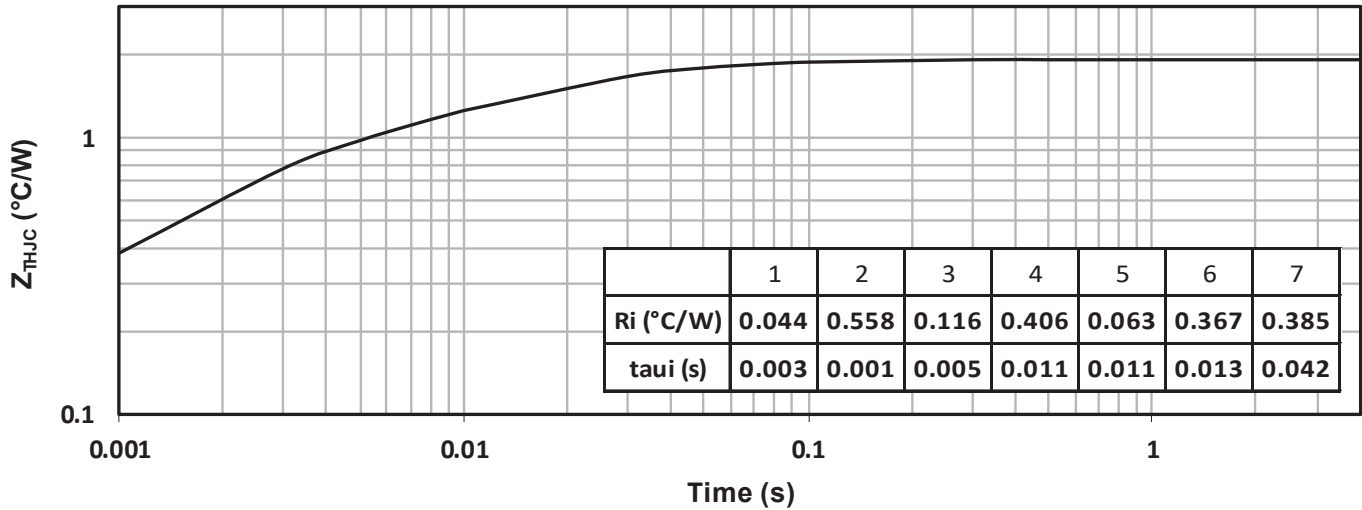

Figure 1-16. Forward Characteristics

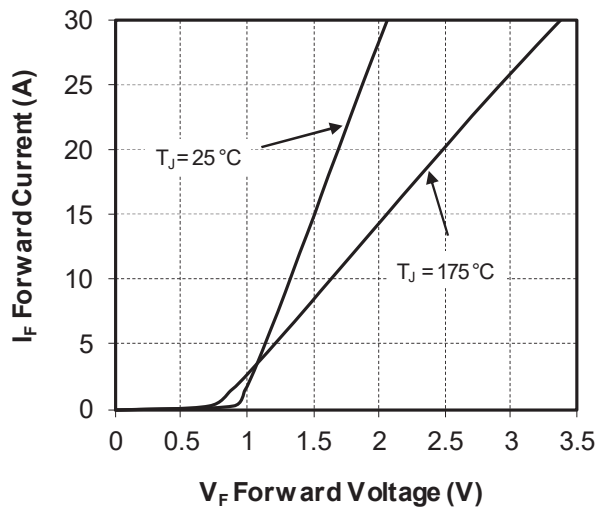
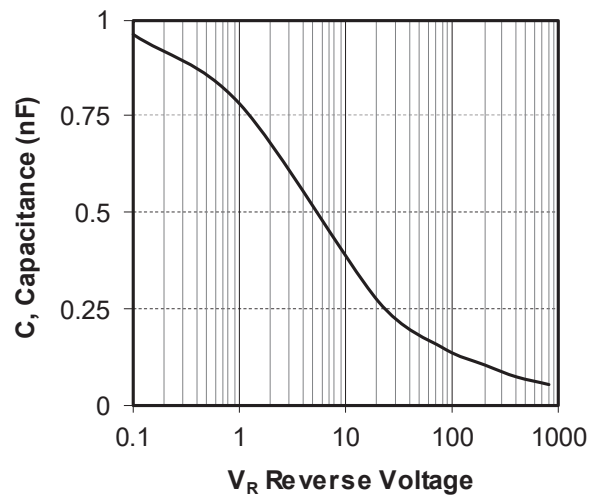

Figure 1-17. Capacitance vs. Reverse Voltage



1.12 Typical SiC MOSFET Performance Curve (Q7)

The following figures show the performance curves of the Q7 SiC MOSFETs.

Figure 1-18. Maximum Thermal Impedance

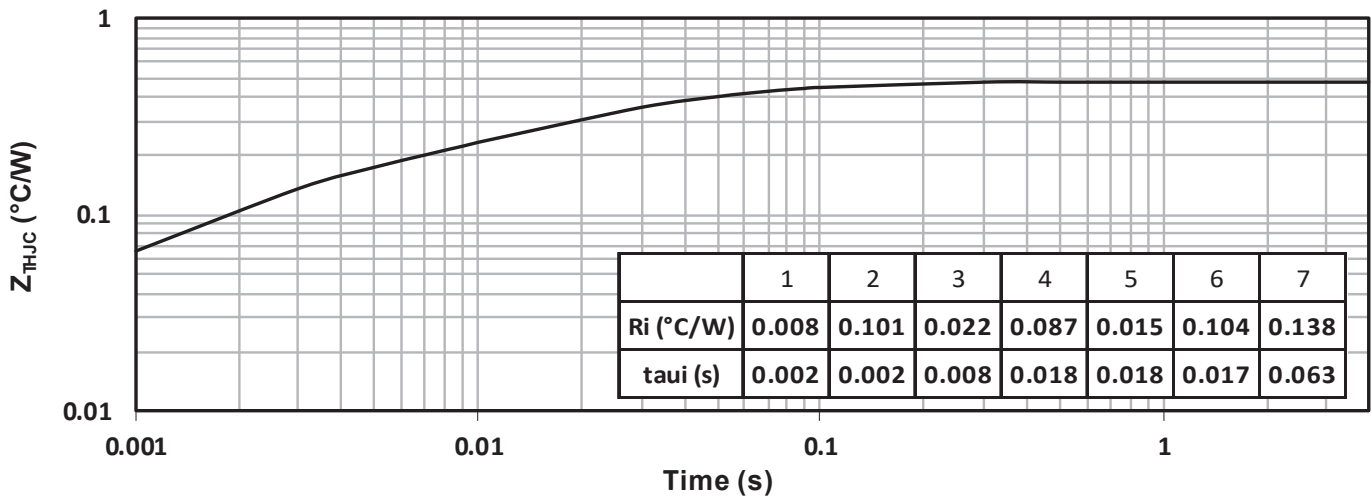

Figure 1-19. Output Characteristics, $T_J = 25\text{ }^\circ\text{C}$

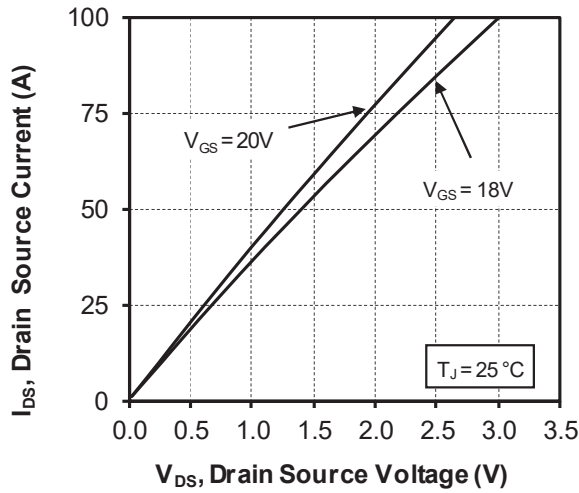

Figure 1-20. Output Characteristics, $T_J = 175\text{ }^\circ\text{C}$

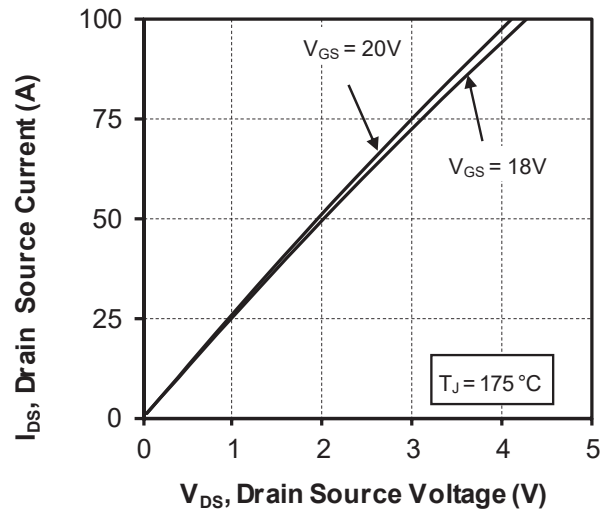

Figure 1-21. Normalized $R_{DS(on)}$ vs. Temperature

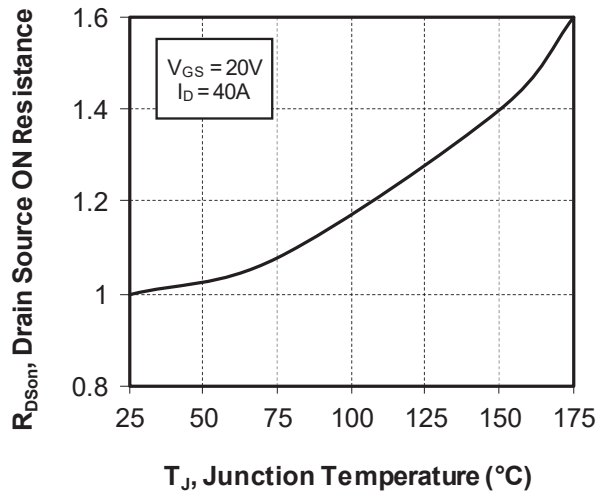

Figure 1-22. Transfer Characteristics

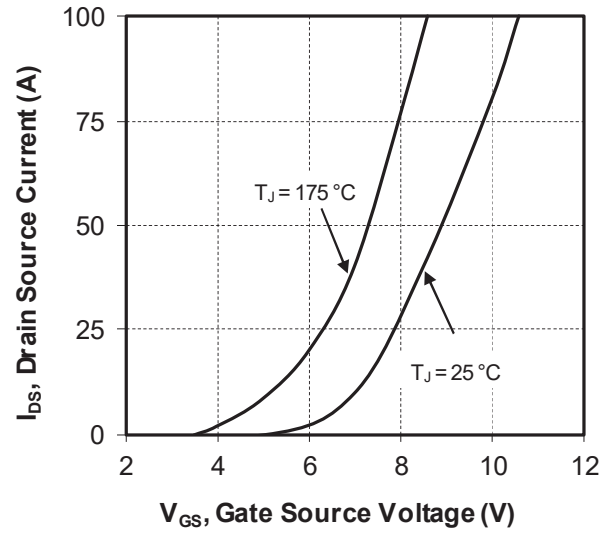

Figure 1-23. Switching Energy vs. R_g

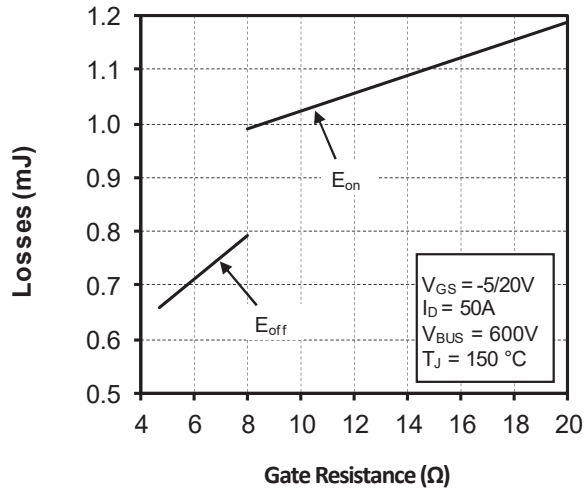

Figure 1-24. Switching Energy vs. Current

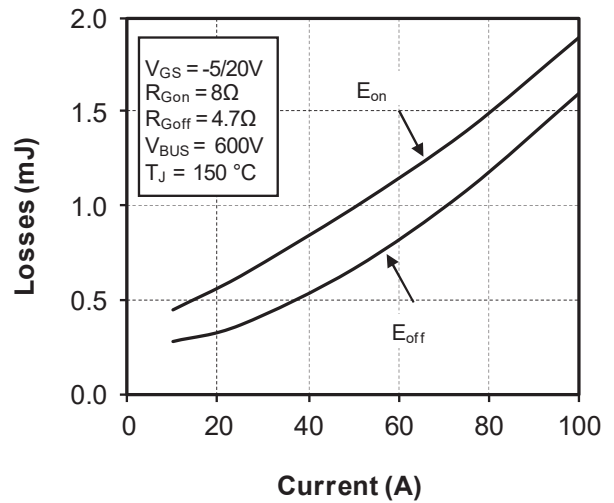

Figure 1-25. Capacitance vs. Drain Source Voltage

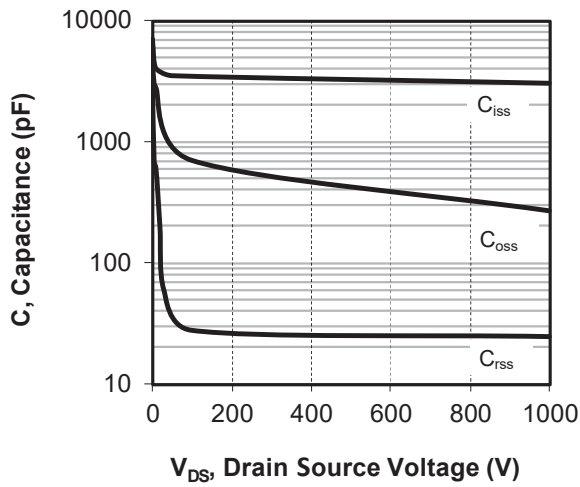

Figure 1-26. Gate Charge vs. Gate Source Voltage

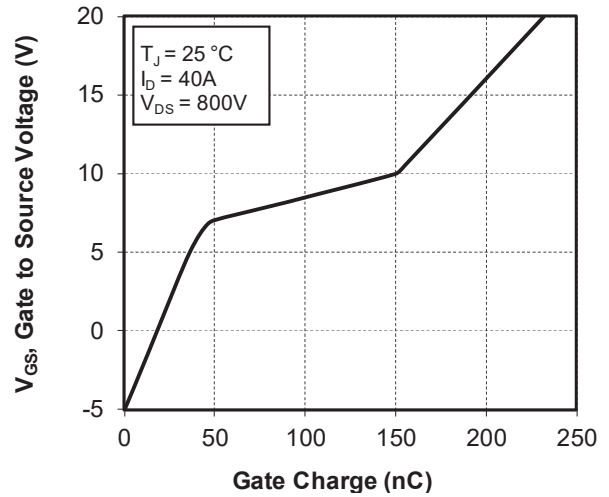

Figure 1-27. Body Diode Characteristics, $T_J = 25^\circ\text{C}$

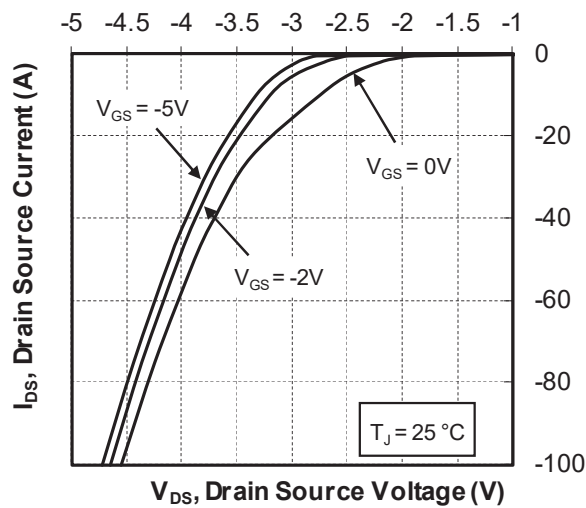

Figure 1-28. 3rd Quadrant Characteristics, $T_J = 25^\circ\text{C}$

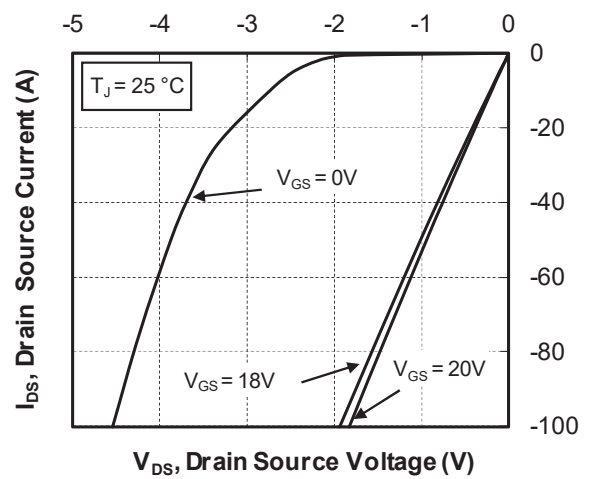

Figure 1-29. Body Diode Characteristics, $T_J = 175\text{ }^\circ\text{C}$

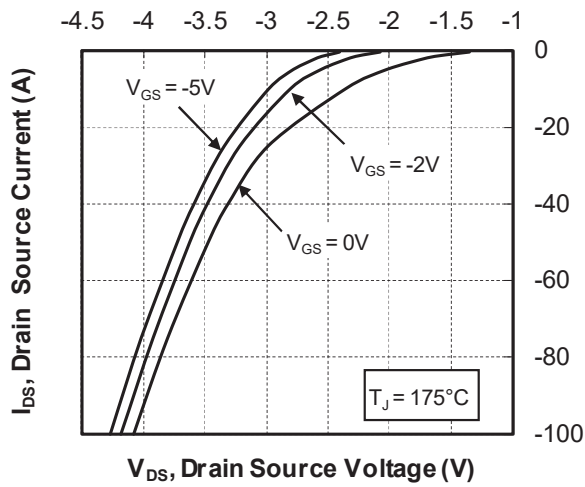

Figure 1-30. 3rd Quadrant Characteristics, $T_J = 175\text{ }^\circ\text{C}$

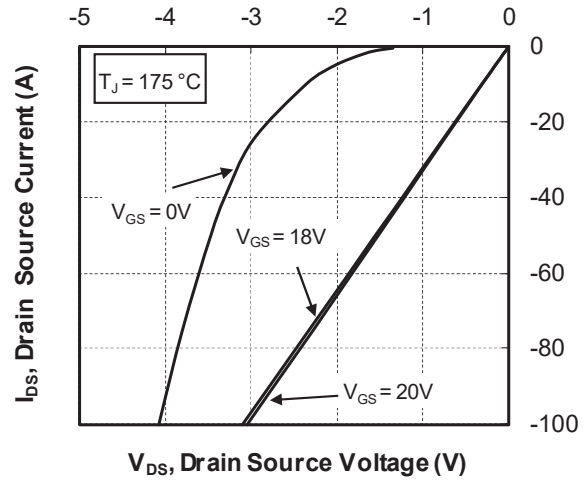
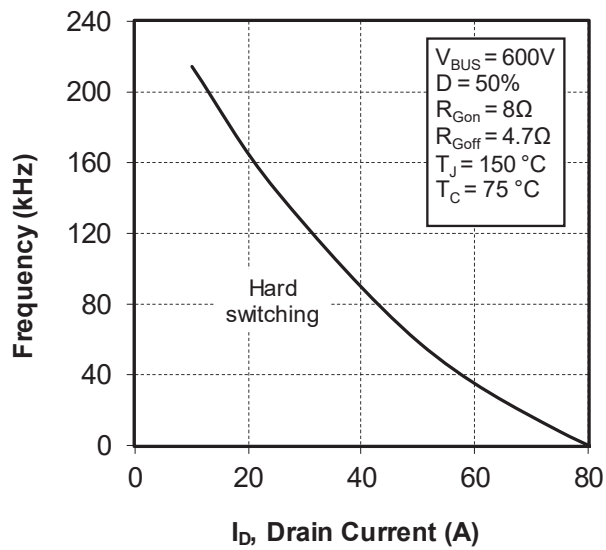

Figure 1-31. Operating Frequency vs. Drain Current



1.13 Typical SiC Diode Performance Curve (CR7 to CR8)

The following figures show the performance curves of the CR7 to CR8 SiC diodes.

Figure 1-32. Maximum Thermal Impedance

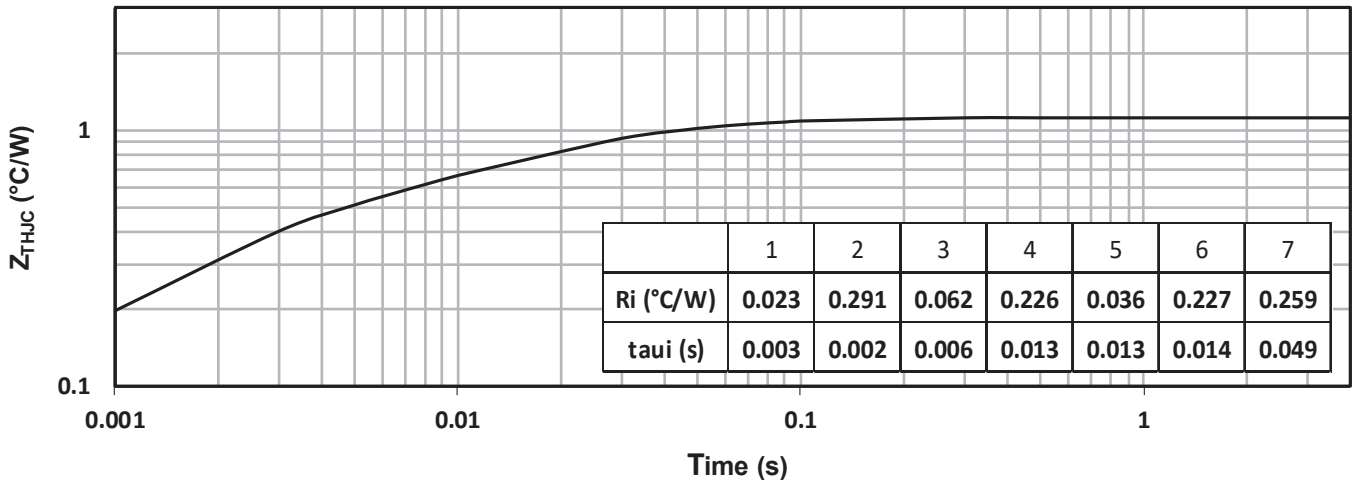

Figure 1-33. Forward Characteristics

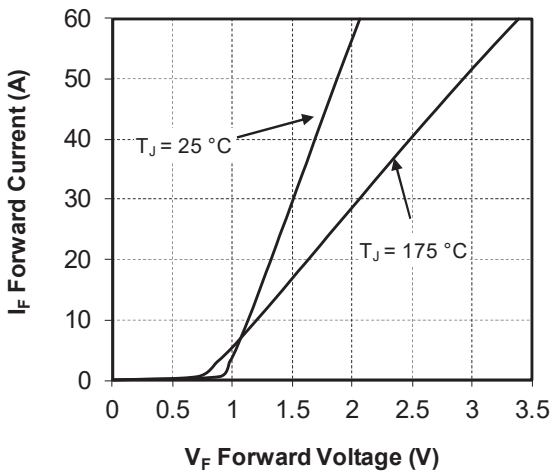
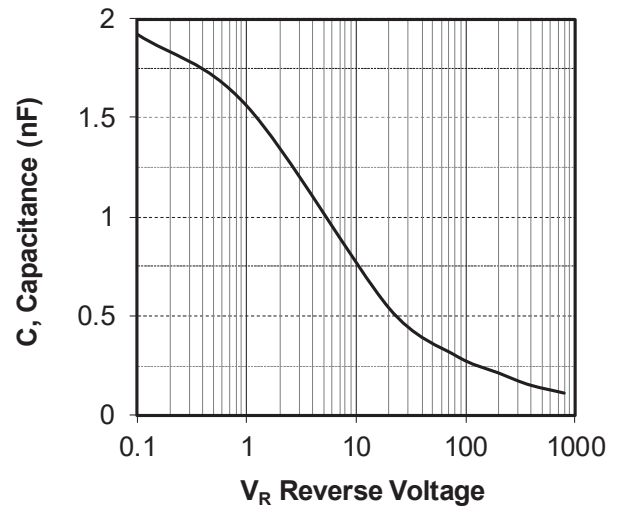

Figure 1-34. Capacitance vs. Reverse Voltage



1.14 Typical IGBT Performance Curve (Q9 and Q10)

The following figures show the performance curves of the Q9 and Q10 IGBTs.

Figure 1-35. Maximum Thermal Impedance

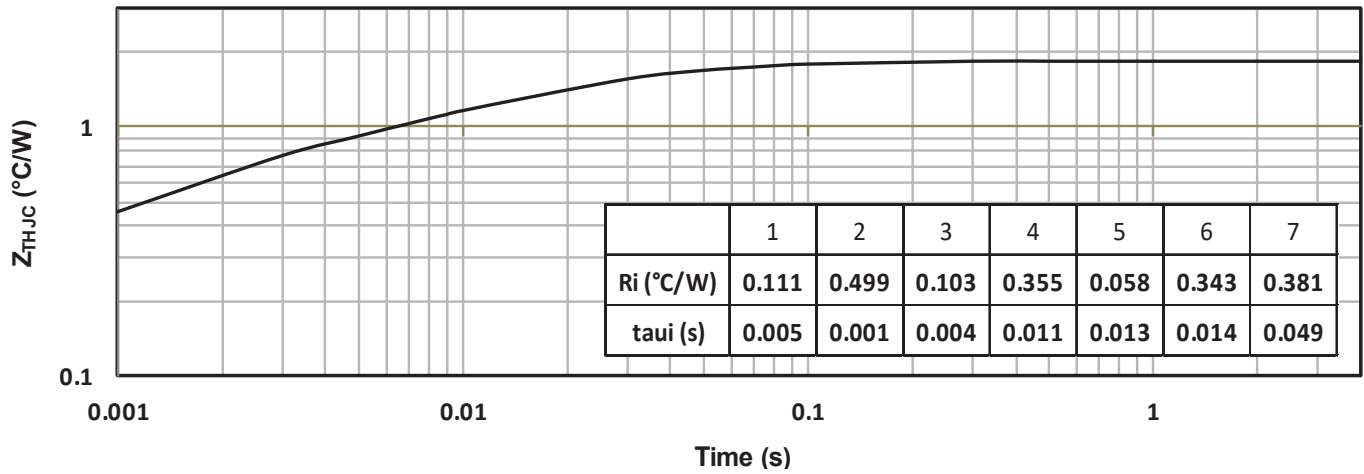
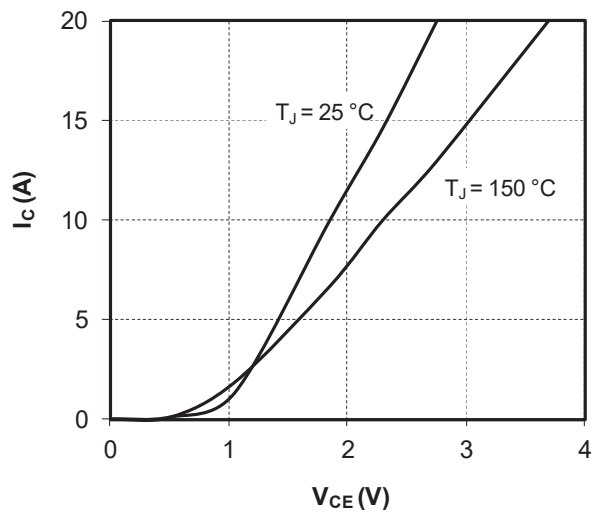

Figure 1-36. Output Characteristics ($V_{GE} = 15V$)



1.15 Typical SiC Diode Performance Curve (CR9 and CR10)

The following figures show the performance curves of the CR9 and CR10 SiC diodes.

Figure 1-37. Maximum Thermal Impedance

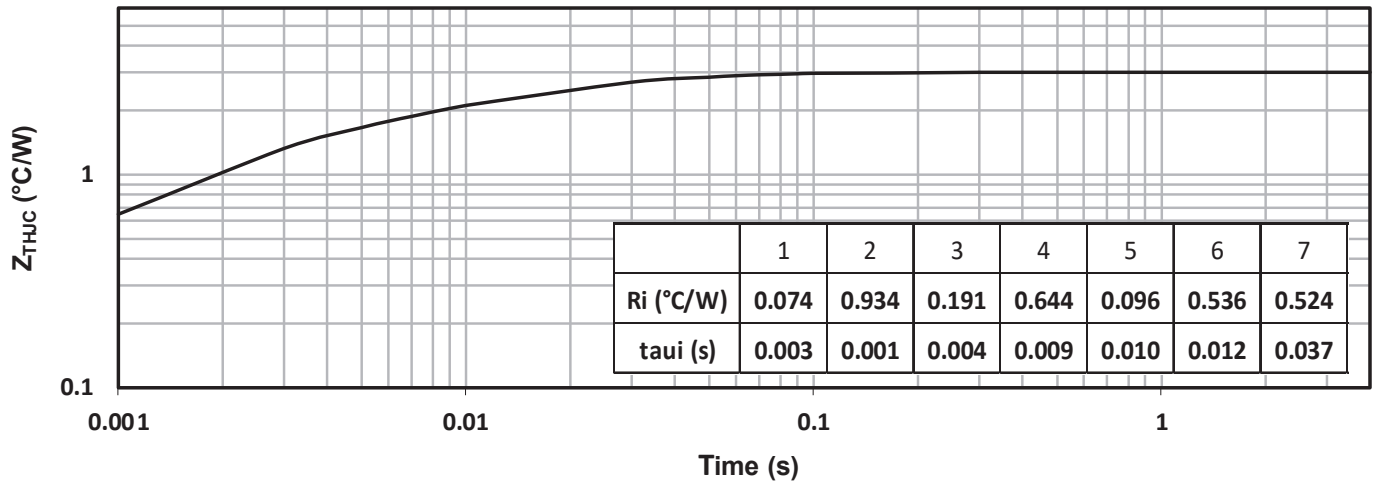

Figure 1-38. Forward Characteristics

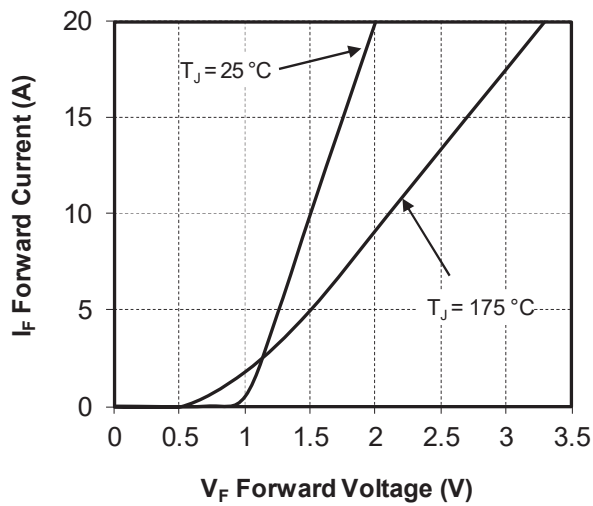
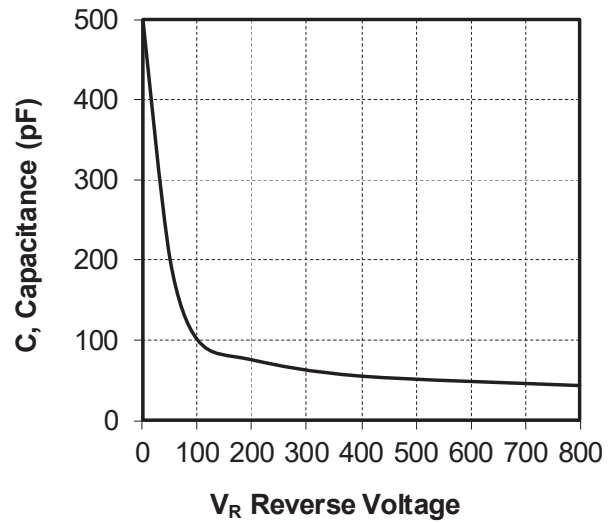

Figure 1-39. Capacitance vs. Reverse Voltage



2. Package Specifications

The following section describes the package specification of the MSCSM120XM50CTYZBNMG device.

2.1 Package Outline

The following figure shows the package outline drawing of the MSCSM120XM50CTYZBNMG device. The dimensions in the following figure are in millimeters.

Figure 2-1. Package Outline Drawing

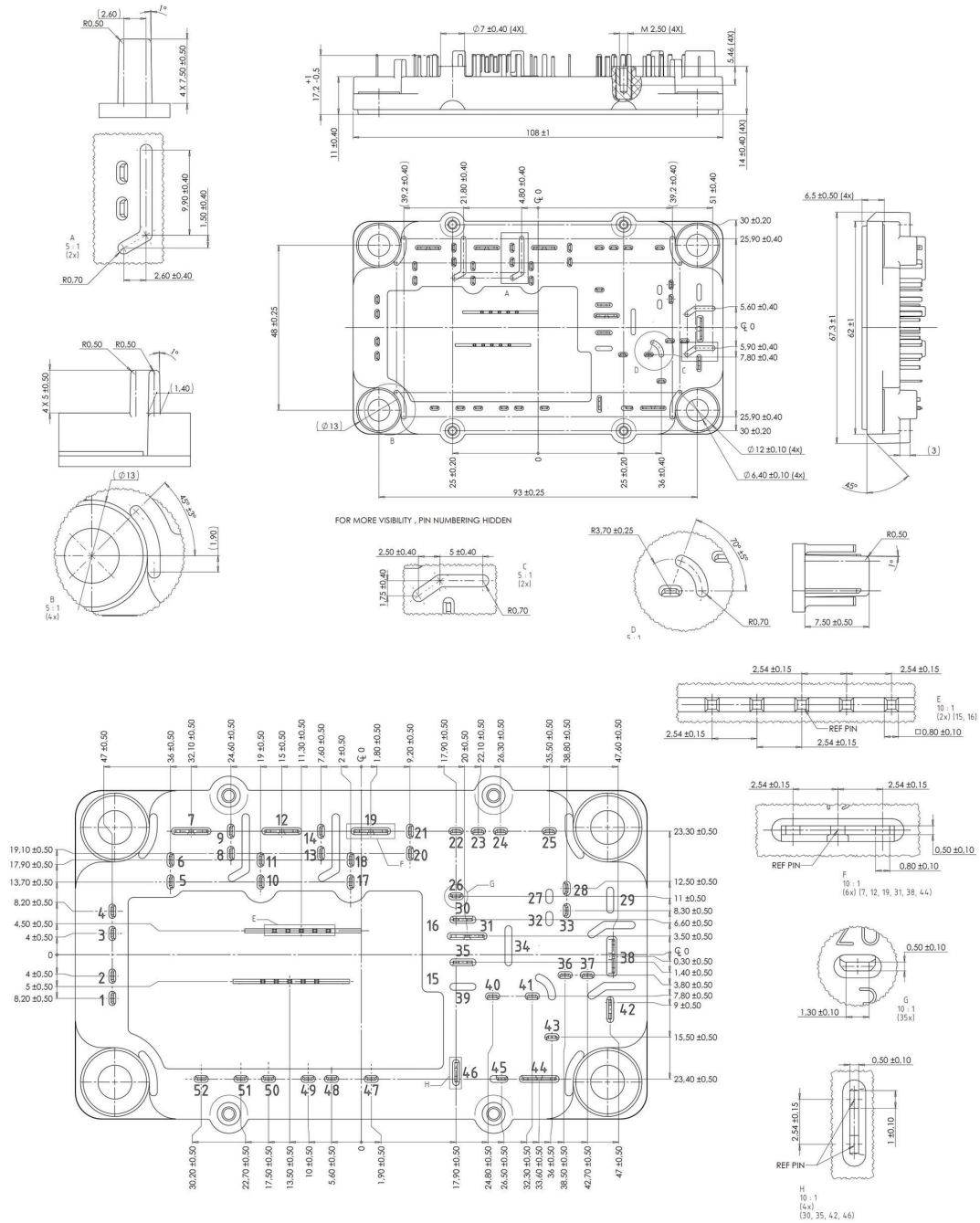

3. Revision History

The revision history describes the changes that were implemented in the document. The changes are listed by revision, starting with the most current publication.

Revision	Date	Description
A	04/2023	Initial revision

Microchip Information

The Microchip Website

Microchip provides online support via our website at www.microchip.com/. This website is used to make files and information easily available to customers. Some of the content available includes:

- **Product Support** – Data sheets and errata, application notes and sample programs, design resources, user’s guides and hardware support documents, latest software releases and archived software
- **General Technical Support** – Frequently Asked Questions (FAQs), technical support requests, online discussion groups, Microchip design partner program member listing
- **Business of Microchip** – Product selector and ordering guides, latest Microchip press releases, listing of seminars and events, listings of Microchip sales offices, distributors and factory representatives

Product Change Notification Service

Microchip’s product change notification service helps keep customers current on Microchip products. Subscribers will receive email notification whenever there are changes, updates, revisions or errata related to a specified product family or development tool of interest.

To register, go to www.microchip.com/pcn and follow the registration instructions.

Customer Support

Users of Microchip products can receive assistance through several channels:

- Distributor or Representative
- Local Sales Office
- Embedded Solutions Engineer (ESE)
- Technical Support

Customers should contact their distributor, representative or ESE for support. Local sales offices are also available to help customers. A listing of sales offices and locations is included in this document.

Technical support is available through the website at: www.microchip.com/support

Microchip Devices Code Protection Feature

Note the following details of the code protection feature on Microchip products:

- Microchip products meet the specifications contained in their particular Microchip Data Sheet.
- Microchip believes that its family of products is secure when used in the intended manner, within operating specifications, and under normal conditions.
- Microchip values and aggressively protects its intellectual property rights. Attempts to breach the code protection features of Microchip product is strictly prohibited and may violate the Digital Millennium Copyright Act.
- Neither Microchip nor any other semiconductor manufacturer can guarantee the security of its code. Code protection does not mean that we are guaranteeing the product is “unbreakable”. Code protection is constantly evolving. Microchip is committed to continuously improving the code protection features of our products.

Legal Notice

This publication and the information herein may be used only with Microchip products, including to design, test, and integrate Microchip products with your application. Use of this information in any other manner violates these terms. Information regarding device applications is provided only for your convenience and may be superseded by updates. It is your responsibility to ensure

that your application meets with your specifications. Contact your local Microchip sales office for additional support or, obtain additional support at www.microchip.com/en-us/support/design-help/client-support-services.

THIS INFORMATION IS PROVIDED BY MICROCHIP "AS IS". MICROCHIP MAKES NO REPRESENTATIONS OR WARRANTIES OF ANY KIND WHETHER EXPRESS OR IMPLIED, WRITTEN OR ORAL, STATUTORY OR OTHERWISE, RELATED TO THE INFORMATION INCLUDING BUT NOT LIMITED TO ANY IMPLIED WARRANTIES OF NON-INFRINGEMENT, MERCHANTABILITY, AND FITNESS FOR A PARTICULAR PURPOSE, OR WARRANTIES RELATED TO ITS CONDITION, QUALITY, OR PERFORMANCE.

IN NO EVENT WILL MICROCHIP BE LIABLE FOR ANY INDIRECT, SPECIAL, PUNITIVE, INCIDENTAL, OR CONSEQUENTIAL LOSS, DAMAGE, COST, OR EXPENSE OF ANY KIND WHATSOEVER RELATED TO THE INFORMATION OR ITS USE, HOWEVER CAUSED, EVEN IF MICROCHIP HAS BEEN ADVISED OF THE POSSIBILITY OR THE DAMAGES ARE FORESEEABLE. TO THE FULLEST EXTENT ALLOWED BY LAW, MICROCHIP'S TOTAL LIABILITY ON ALL CLAIMS IN ANY WAY RELATED TO THE INFORMATION OR ITS USE WILL NOT EXCEED THE AMOUNT OF FEES, IF ANY, THAT YOU HAVE PAID DIRECTLY TO MICROCHIP FOR THE INFORMATION.

Use of Microchip devices in life support and/or safety applications is entirely at the buyer's risk, and the buyer agrees to defend, indemnify and hold harmless Microchip from any and all damages, claims, suits, or expenses resulting from such use. No licenses are conveyed, implicitly or otherwise, under any Microchip intellectual property rights unless otherwise stated.

Trademarks

The Microchip name and logo, the Microchip logo, Adaptec, AVR, AVR logo, AVR Freaks, BesTime, BitCloud, CryptoMemory, CryptoRF, dsPIC, flexPWR, HELDO, IGLOO, JukeBlox, KeeLoq, Klear, LANCheck, LinkMD, maXStylus, maXTouch, MediaLB, megaAVR, Microsemi, Microsemi logo, MOST, MOST logo, MPLAB, OptoLyzer, PIC, picoPower, PICSTART, PIC32 logo, PolarFire, Prochip Designer, QTouch, SAM-BA, SenGenuity, SpyNIC, SST, SST Logo, SuperFlash, Symmetricom, SyncServer, Tachyon, TimeSource, tinyAVR, UNI/O, Vectron, and XMEGA are registered trademarks of Microchip Technology Incorporated in the U.S.A. and other countries.

AgileSwitch, APT, ClockWorks, The Embedded Control Solutions Company, EtherSynch, Flashtec, Hyper Speed Control, HyperLight Load, Libero, motorBench, mTouch, Powermite 3, Precision Edge, ProASIC, ProASIC Plus, ProASIC Plus logo, Quiet-Wire, SmartFusion, SyncWorld, Temux, TimeCesium, TimeHub, TimePictra, TimeProvider, TrueTime, and ZL are registered trademarks of Microchip Technology Incorporated in the U.S.A.

Adjacent Key Suppression, AKS, Analog-for-the-Digital Age, Any Capacitor, AnyIn, AnyOut, Augmented Switching, BlueSky, BodyCom, Clockstudio, CodeGuard, CryptoAuthentication, CryptoAutomotive, CryptoCompanion, CryptoController, dsPICDEM, dsPICDEM.net, Dynamic Average Matching, DAM, ECAN, Espresso T1S, EtherGREEN, GridTime, IdealBridge, In-Circuit Serial Programming, ICSP, INICnet, Intelligent Paralleling, IntelliMOS, Inter-Chip Connectivity, JitterBlocker, Knob-on-Display, KoD, maxCrypto, maxView, memBrain, Mindi, MiWi, MPASM, MPF, MPLAB Certified logo, MPLIB, MPLINK, MultiTRAK, NetDetach, Omniscient Code Generation, PICDEM, PICDEM.net, PICkit, PICtail, PowerSmart, PureSilicon, QMatrix, REAL ICE, Ripple Blocker, RTAX, RTG4, SAM-ICE, Serial Quad I/O, simpleMAP, SimpliPHY, SmartBuffer, SmartHLS, SMART-I.S., storClad, SQL, SuperSwitcher, SuperSwitcher II, Switchtec, SynchroPHY, Total Endurance, Trusted Time, TSHARC, USBCheck, VariSense, VectorBlox, VeriPHY, ViewSpan, WiperLock, XpressConnect, and ZENA are trademarks of Microchip Technology Incorporated in the U.S.A. and other countries.

SQTP is a service mark of Microchip Technology Incorporated in the U.S.A.

The Adaptec logo, Frequency on Demand, Silicon Storage Technology, and Symmcom are registered trademarks of Microchip Technology Inc. in other countries.

GestIC is a registered trademark of Microchip Technology Germany II GmbH & Co. KG, a subsidiary of Microchip Technology Inc., in other countries.

All other trademarks mentioned herein are property of their respective companies.

© 2023, Microchip Technology Incorporated and its subsidiaries. All Rights Reserved.

ISBN: 978-1-6683-2359-5

Quality Management System

For information regarding Microchip's Quality Management Systems, please visit www.microchip.com/quality.

Worldwide Sales and Service

AMERICAS	ASIA/PACIFIC	ASIA/PACIFIC	EUROPE
<p>Corporate Office 2355 West Chandler Blvd. Chandler, AZ 85224-6199 Tel: 480-792-7200 Fax: 480-792-7277 Technical Support: www.microchip.com/support Web Address: www.microchip.com</p> <p>Atlanta Duluth, GA Tel: 678-957-9614 Fax: 678-957-1455</p> <p>Austin, TX Tel: 512-257-3370</p> <p>Boston Westborough, MA Tel: 774-760-0087 Fax: 774-760-0088</p> <p>Chicago Itasca, IL Tel: 630-285-0071 Fax: 630-285-0075</p> <p>Dallas Addison, TX Tel: 972-818-7423 Fax: 972-818-2924</p> <p>Detroit Novi, MI Tel: 248-848-4000</p> <p>Houston, TX Tel: 281-894-5983</p> <p>Indianapolis Noblesville, IN Tel: 317-773-8323 Fax: 317-773-5453 Tel: 317-536-2380</p> <p>Los Angeles Mission Viejo, CA Tel: 949-462-9523 Fax: 949-462-9608 Tel: 951-273-7800</p> <p>Raleigh, NC Tel: 919-844-7510</p> <p>New York, NY Tel: 631-435-6000</p> <p>San Jose, CA Tel: 408-735-9110 Tel: 408-436-4270</p> <p>Canada - Toronto Tel: 905-695-1980 Fax: 905-695-2078</p>	<p>Australia - Sydney Tel: 61-2-9868-6733</p> <p>China - Beijing Tel: 86-10-8569-7000</p> <p>China - Chengdu Tel: 86-28-8665-5511</p> <p>China - Chongqing Tel: 86-23-8980-9588</p> <p>China - Dongguan Tel: 86-769-8702-9880</p> <p>China - Guangzhou Tel: 86-20-8755-8029</p> <p>China - Hangzhou Tel: 86-571-8792-8115</p> <p>China - Hong Kong SAR Tel: 852-2943-5100</p> <p>China - Nanjing Tel: 86-25-8473-2460</p> <p>China - Qingdao Tel: 86-532-8502-7355</p> <p>China - Shanghai Tel: 86-21-3326-8000</p> <p>China - Shenyang Tel: 86-24-2334-2829</p> <p>China - Shenzhen Tel: 86-755-8864-2200</p> <p>China - Suzhou Tel: 86-186-6233-1526</p> <p>China - Wuhan Tel: 86-27-5980-5300</p> <p>China - Xian Tel: 86-29-8833-7252</p> <p>China - Xiamen Tel: 86-592-2388138</p> <p>China - Zhuhai Tel: 86-756-3210040</p>	<p>India - Bangalore Tel: 91-80-3090-4444</p> <p>India - New Delhi Tel: 91-11-4160-8631</p> <p>India - Pune Tel: 91-20-4121-0141</p> <p>Japan - Osaka Tel: 81-6-6152-7160</p> <p>Japan - Tokyo Tel: 81-3-6880-3770</p> <p>Korea - Daegu Tel: 82-53-744-4301</p> <p>Korea - Seoul Tel: 82-2-554-7200</p> <p>Malaysia - Kuala Lumpur Tel: 60-3-7651-7906</p> <p>Malaysia - Penang Tel: 60-4-227-8870</p> <p>Philippines - Manila Tel: 63-2-634-9065</p> <p>Singapore Tel: 65-6334-8870</p> <p>Taiwan - Hsin Chu Tel: 886-3-577-8366</p> <p>Taiwan - Kaohsiung Tel: 886-7-213-7830</p> <p>Taiwan - Taipei Tel: 886-2-2508-8600</p> <p>Thailand - Bangkok Tel: 66-2-694-1351</p> <p>Vietnam - Ho Chi Minh Tel: 84-28-5448-2100</p>	<p>Austria - Wels Tel: 43-7242-2244-39 Fax: 43-7242-2244-393</p> <p>Denmark - Copenhagen Tel: 45-4485-5910 Fax: 45-4485-2829</p> <p>Finland - Espoo Tel: 358-9-4520-820</p> <p>France - Paris Tel: 33-1-69-53-63-20 Fax: 33-1-69-30-90-79</p> <p>Germany - Garching Tel: 49-8931-9700</p> <p>Germany - Haan Tel: 49-2129-3766400</p> <p>Germany - Heilbronn Tel: 49-7131-72400</p> <p>Germany - Karlsruhe Tel: 49-721-625370</p> <p>Germany - Munich Tel: 49-89-627-144-0 Fax: 49-89-627-144-44</p> <p>Germany - Rosenheim Tel: 49-8031-354-560</p> <p>Israel - Ra'anana Tel: 972-9-744-7705</p> <p>Italy - Milan Tel: 39-0331-742611 Fax: 39-0331-466781</p> <p>Italy - Padova Tel: 39-049-7625286</p> <p>Netherlands - Drunen Tel: 31-416-690399 Fax: 31-416-690340</p> <p>Norway - Trondheim Tel: 47-72884388</p> <p>Poland - Warsaw Tel: 48-22-3325737</p> <p>Romania - Bucharest Tel: 40-21-407-87-50</p> <p>Spain - Madrid Tel: 34-91-708-08-90 Fax: 34-91-708-08-91</p> <p>Sweden - Gothenberg Tel: 46-31-704-60-40</p> <p>Sweden - Stockholm Tel: 46-8-5090-4654</p> <p>UK - Wokingham Tel: 44-118-921-5800 Fax: 44-118-921-5820</p>