

**Microchip**

**Filter specification**

**TFS140AN**

**1/5**

**Measurement condition**

Ambient temperature $T_A$ :	23	°C
Input power level:	0	dBm
Terminating impedance: *		
Input:	35 $\Omega$	-66 pF
Output:	22 $\Omega$	-78 pF

**Characteristics**

Remark:

The nominal frequency  $f_N$  is fixed at 140.0 MHz. The insertion loss  $a_e$  is defined as loss value determined at  $f_N$ . Reference level for the relative attenuation  $a_{rel}$  of the TFS 140AN is the insertion loss  $a_e$ . The centre frequency  $f_C$  is the arithmetic mean value of the upper and lower frequencies at the 20 dB filter attenuation level relative to the insertion loss  $a_e$ . All specified data are met within the operating temperature range.

D a t a		typ. value		tolerance / limit		
<b>Insertion loss</b> (reference level)	$a_e$	7.2	dB	max.	10.0	dB
<b>Nominal frequency</b>	$f_N$	-			140.0	MHz
<b>Centre frequency</b>	$f_C$	140	MHz		-	
<b>Passband</b>	PB	14.8	MHz	$f_N \pm$	4.8	MHz
<b>Pass band ripple</b>		0.3	dB	max.	1	dB
<b>Bandwidth</b>	BW					
3 dB		16	MHz	min.	12.0	MHz
30 dB		23	MHz	max.	36.0	MHz
<b>Relative attenuation</b>	$a_{rel}$					
$f_N \pm$ 4.8 MHz	$f_N \pm$ 4.8 MHz	0.4	dB	max.	1	dB
$f_N \pm$ 6.0 MHz	$f_N \pm$ 6.0 MHz	0.5	dB	max.	3	dB
$f_N -$ 20.0 MHz	$f_N -$ 20.0 MHz	58	dB	min.	40	dB
$f_N +$ 20.0 MHz	$f_N +$ 370.0 MHz	55	dB	min.	40	dB
<b>Group delay ripple within PB</b>	p-p	36	ns	max.	160	ns
<b>Input power level</b>		-		max.	0	dBm
<b>Operating temperature range</b>	OTR	-			- 40 °C ... + 85°C	
<b>Storage temperature range</b>		-			- 55 °C ... + 80°C	
<b>Temperature coefficient of frequency</b>	$TC_f$ **	-90	ppm/K			

\*) The terminating impedances depend on parasitics and q-values of matching elements and the board used, and are to be understood as reference values only. Should there be additional questions do not hesitate to ask for an application note or contact our design team.

\*\*)  $\Delta f = TC_f(T - T_A)f_N$

**Generated:**

---

**Checked / Approved:**

---

**Microchip Frequency Technology GmbH**  
**Potsdamer Straße 18**  
**D 14 513 TELTOW / Germany**  
**Tel: (+49) 3328 4784-0 / Fax: (+49) 3328 4784-30**

Microchip Frequency Technology GmbH reserves the right to make changes to the product(s) and/or information contained herein without notice. No liability is assumed as a result of their use or application. No rights under any patent accompany the sale of any such product(s) or information.

**Filter characteristic**

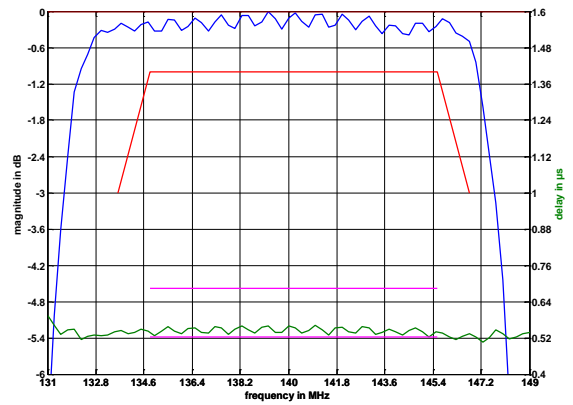
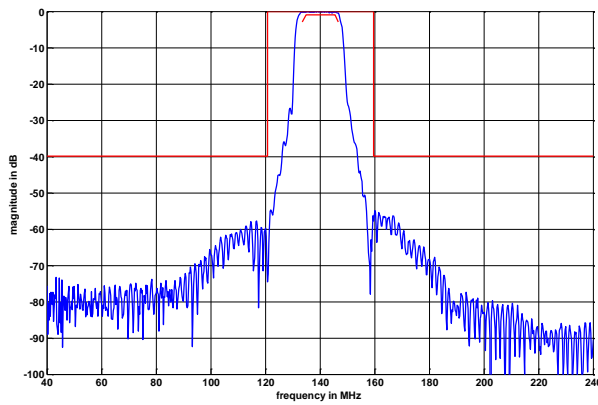

**Construction and pin connection**

(All dimensions in mm)

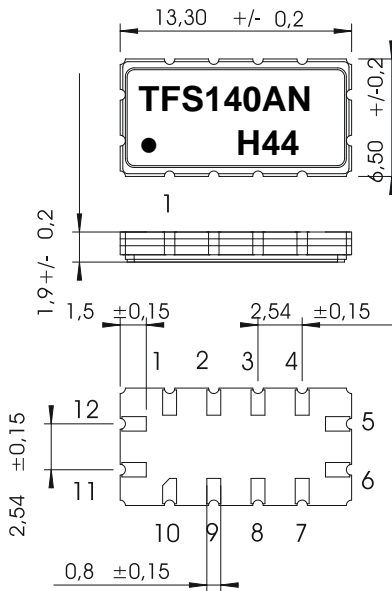

- 1 Ground
- 2 Ground
- 3 Ground
- 4 Ground
- 5 Output
- 6 Output RF Return
- 7 Ground
- 8 Ground
- 9 Ground
- 10 Ground
- 11 Input
- 12 Input RF Return

Date code: Year + week  
 H 2016  
 J 2017  
 K 2018  
 ...

**50 Ω Test circuit**

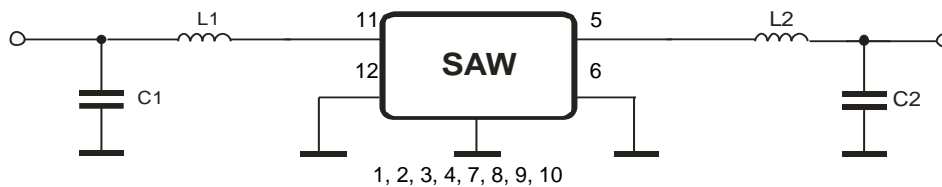

**Microchip Frequency Technology GmbH**  
 Potsdamer Straße 18  
 D 14 513 TELTOW / Germany  
 Tel: (+49) 3328 4784-0 / Fax: (+49) 3328 4784-30

Microchip Frequency Technology GmbH reserves the right to make changes to the product(s) and/or information contained herein without notice. No liability is assumed as a result of their use or application. No rights under any patent accompany the sale of any such product(s) or information.

**Stability characteristics, reliability**

After the following tests the filter shall meet the whole specification:

1. Shock: 500 g, 1 ms, half sine wave, 3 shocks each plane;  
DIN IEC 60068 T2 - 27
2. Vibration: 10 Hz to 2000 Hz, 0.35 mm or 5 g respectively, 1 octave per min, 10 cycles per plane, 3 planes; DIN IEC 60068 T2 - 6
3. Change of temperature: -55 °C to 125 °C / 15 min. each / 100 cycles  
DIN IEC 60068 part 2 – 14 Test N
4. Resistance to solder heat (reflow): reflow possible: three times max.;  
for temperature conditions refer to the attached "Air reflow temperature conditions" on page 4;
5. SAW devices are Electrostatic Discharge (ESD) sensitive devices.

This filter is RoHS compliant (2011/65/EU)

**Packing**

Tape & Reel: IEC 286 – 3, with exception of value for N and minimum bending radius;  
tape type II, embossed carrier tape with top cover tape on the upper side;

max. pieces of filters per reel:	1700
reel of empty components at start:	min. 300 mm
reel of empty components at start including leader:	min. 500 mm
trailer:	min. 300 mm

**Tape (all dimensions in mm)**

- W : 24.00 +0.30/-0.10
- Po : 4.00 ±0.1
- Do : 1.50 +0.1/0
- E : 1.75 ±0.10
- F : 11.50 ±0.10
- G(min) : 0.60
- P2 : 2.00 ±0.1
- P1 : 12.00 ±0.1
- D1(min) : 1.50
- Ao : 7.00 ±0.10
- Bo : 13.80 ±0.10
- Ct : 21.00 ±0.1
- Ko : 2.10 ±0.10
- t : 0.30 ±0.05

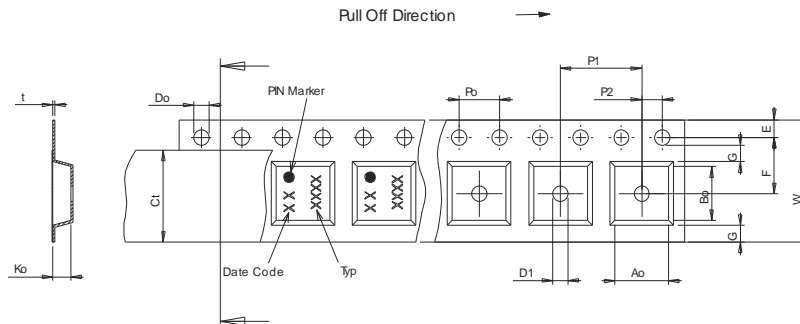

**Reel (all dimensions in mm)**

- A : 330 or 180
- W1 : 24.4 +2/-0
- W2(max) : 30.40
- N(min) : 60.00
- C : 13.0 +0.5/-0.2

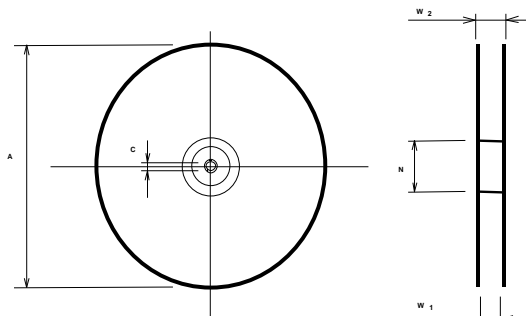

The minimum bending radius is 45 mm.

**Microchip Frequency Technology GmbH**  
**Potsdamer Straße 18**  
**D 14 513 TELTOW / Germany**  
**Tel: (+49) 3328 4784-0 / Fax: (+49) 3328 4784-30**

Microchip Frequency Technology GmbH reserves the right to make changes to the product(s) and/or information contained herein without notice. No liability is assumed as a result of their use or application. No rights under any patent accompany the sale of any such product(s) or information.

**Air reflow temperature conditions**

<b>Conditions</b>	<b>Exposure</b>
Average ramp-up rate (30 °C to 217 °C)	less than 3 °C / second
> 100 °C	between 300 and 600 seconds
> 150 °C	between 240 and 500 seconds
> 217 °C	between 30 and 150 seconds
Peak temperature	max. 260 °C
Time within 5 °C of actual peak temperature	between 10 and 30 seconds
Cool-down rate (Peak to 50 °C)	less than 6 °C / second
Time from 30 °C to Peak temperature	no greater than 300 seconds

**Chip-mount air reflow profile**

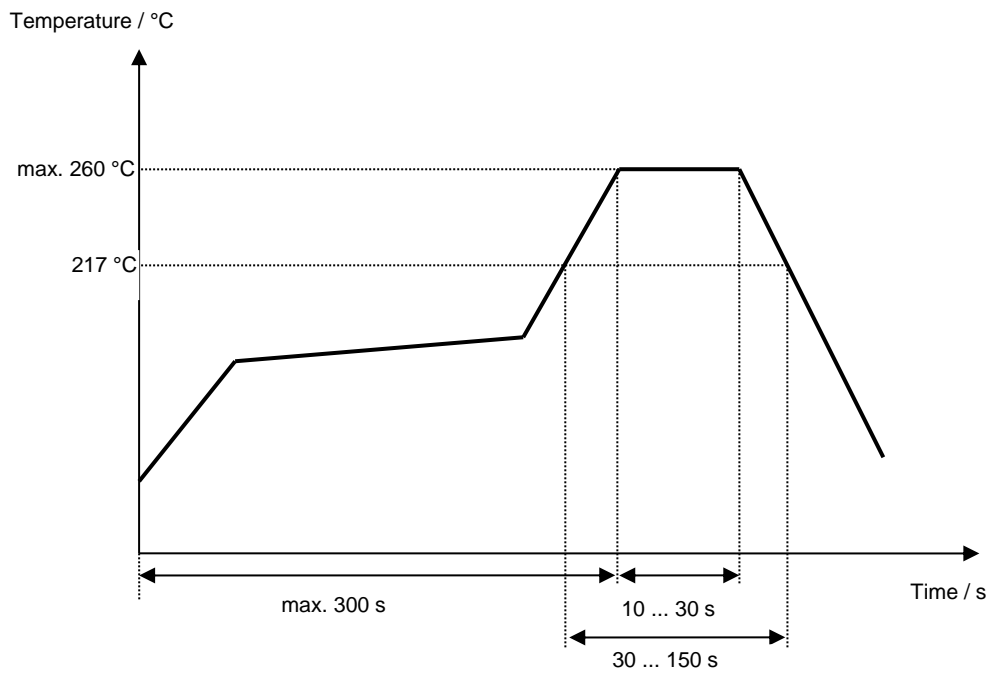

**Microchip Frequency Technology GmbH**  
**Potsdamer Straße 18**  
**D 14 513 TELTOW / Germany**  
**Tel: (+49) 3328 4784-0 / Fax: (+49) 3328 4784-30**

Microchip Frequency Technology GmbH reserves the right to make changes to the product(s) and/or information contained herein without notice. No liability is assumed as a result of their use or application. No rights under any patent accompany the sale of any such product(s) or information.

**Microchip****Filter specification****TFS140AN****5/5****History**

<b>Version</b>	<b>Reason of Changes</b>	<b>Name</b>	<b>Date</b>
1.0	- Generation of development specification	Strehl	17.05.2006
1.1	- Change construction	Strehl	24.07.2006
1.2	- Created filter specification - Added terminating impedances - Changed remark - Added typical values - Added temperature coefficient of frequency - Added filter characteristic - Changed construction - Added test circuit - Changed packing	Chilla	14.11.2006
2.0	- Changed operation temperature range according to customer requirement	Noack	26.08.2009
3.0	- Change tape & reel dimensions - Update header and footer sections - Update data section - Update storage temperature range - Update stability characteristics, reliability	Bonnen	28.10.2016

---

**Microchip Frequency Technology GmbH**  
**Potsdamer Straße 18**  
**D 14 513 TELTOW / Germany**  
**Tel: (+49) 3328 4784-0 / Fax: (+49) 3328 4784-30**

---

Microchip Frequency Technology GmbH reserves the right to make changes to the product(s) and/or information contained herein without notice. No liability is assumed as a result of their use or application. No rights under any patent accompany the sale of any such product(s) or information.