

Microchip**Filter specification****TFS931****1/5****Measurement condition**

Ambient temperature T_A : 23 °C
 Input power level: 0 dBm

Terminating impedance:

Input: 50 Ω
 Output: 50 Ω

Characteristics

Remark:

The maximum attenuation in the passband is defined as the insertion loss a_e . The nominal frequency f_N is fixed at 931.5 MHz without any tolerance or limit. The values of absolute attenuation a_{abs} are guaranteed for the whole operating temperature range. The frequency shift of the filter in the operating temperature range is included in the production tolerance scheme.

D a t a		typ. value	tolerance / limit
Insertion loss	a_e	2.3 dB	max. 3.0 dB
Nominal frequency	f_N	-	931.5 MHz
Passband	PB	-	$f_N \pm 6.5$ MHz
Absolute attenuation	a_{abs}		
100 MHz ... 500 MHz		55 dB	min. 50 dB
500 MHz ... 850 MHz		46 dB	min. 44 dB
1020 MHz ... 1200 MHz		43 dB	min. 40 dB
Operating temperature range	OTR	-	- 20 °C ... + 85 °C
Storage temperature range		-	- 55 °C ... + 125 °C
Temperature coefficient of frequency	TC_f *)	-42 ppm/K	

*) $\Delta f = TC_f(T - T_A)f_N$

Generated:

Checked / Approved:

Microchip Frequency Technology GmbH
Potsdamer Straße 18
D 14 513 TELTOW / Germany
Tel: (+49) 3328 4784-0 / Fax: (+49) 3328 4784-30

Microchip Frequency Technology GmbH reserves the right to make changes to the product(s) and/or information contained herein without notice. No liability is assumed as a result of their use or application. No rights under any patent accompany the sale of any such product(s) or information.

Filter characteristic

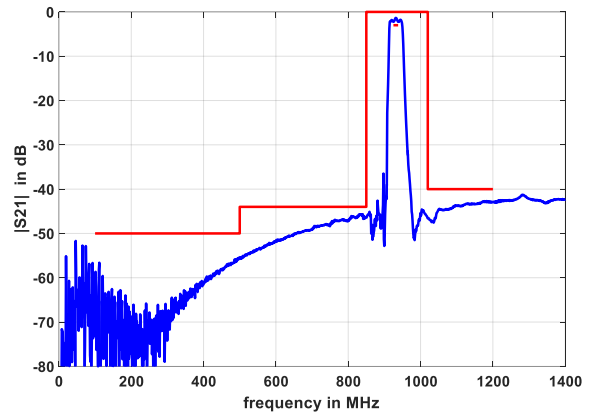
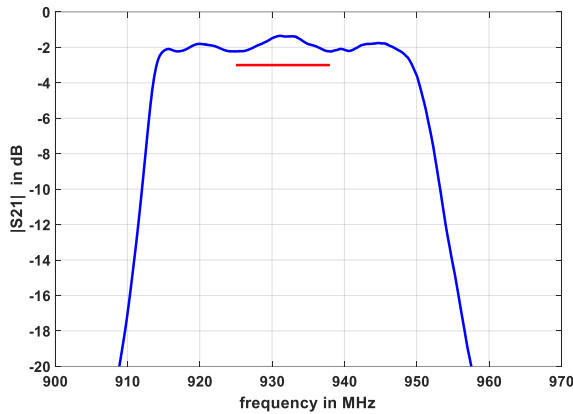

Construction and pin connection

(All dimensions in mm)

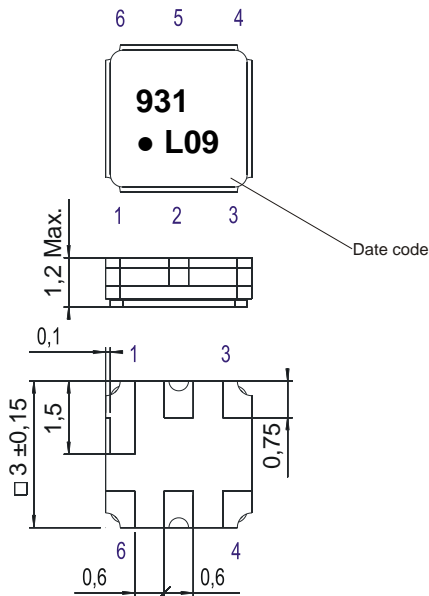

- 1 Ground
- 2 Input
- 3 Ground
- 4 Ground
- 5 Output
- 6 Ground

Date code: Year + week
 L 2019
 M 2020
 N 2021
 ...

50 Ω Test circuit

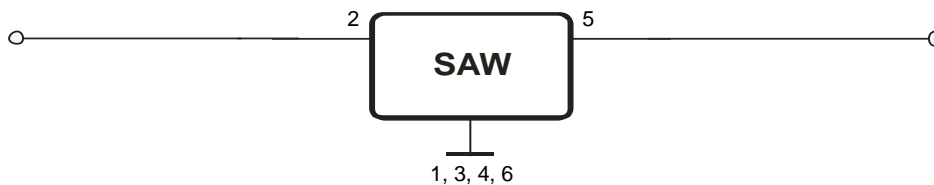

Microchip Frequency Technology GmbH
Potsdamer Straße 18
D 14 513 TELTOW / Germany
Tel: (+49) 3328 4784-0 / Fax: (+49) 3328 4784-30

Microchip Frequency Technology GmbH reserves the right to make changes to the product(s) and/or information contained herein without notice. No liability is assumed as a result of their use or application. No rights under any patent accompany the sale of any such product(s) or information.

Stability characteristics, reliability

After the following tests the filter shall meet the whole specification:

1. Shock: 500 g, 1 ms, half sine wave, 3 shocks each plane;
DIN IEC 60068 T2 - 27
2. Vibration: 10 Hz to 2000 Hz, 0.35 mm or 5 g respectively, 1 octave per min, 10 cycles per plane, 3 planes; DIN IEC 60068 T2 - 6
3. Change of temperature: -55 °C to 125 °C / 15 min. each / 100 cycles
DIN IEC 60068 part 2 – 14 Test N
4. Resistance to solder heat (reflow): reflow possible: three times max.;
for temperature conditions refer to the attached "Air reflow temperature conditions" on page 4;
5. SAW devices are Electrostatic Discharge (ESD) sensitive devices.

This filter is RoHS compliant (2011/65/EU)

Packing

Tape & Reel: IEC 286 – 3, with exception of value for N and minimum bending radius;
tape type II, embossed carrier tape with top cover tape on the upper side;

reel of empty components at start:	min. 300 mm
reel of empty components at start including leader:	min. 500 mm
trailer:	min. 300 mm

Tape (all dimensions in mm)

- W : 8.00 ±0.3
- Po : 4.00 ±0.1
- Do : 1.50 +0.1/-0
- E : 1.75 ±0.1
- F : 3.50 ±0.05
- G(min) : 0.75
- P2 : 2.00 ±0.05
- P1 : 4.00 ±0.1
- D1(min) : 1.50
- Ao : 3.25 ±0.1
- Bo : 3.25 ±0.1
- Ct : 5.30 ±0.1
- Ko : 1.50 ±0.1
- t : 0.25 ±0.05

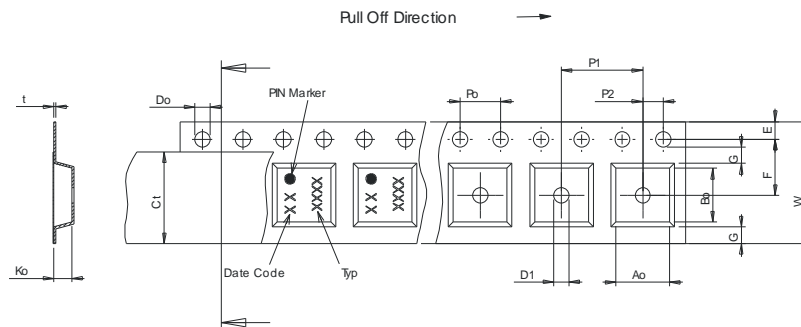

Reel (all dimensions in mm)

- A : 330 or 180
- W1 : 8.40 +1.5/-0
- W2(max) : 14.40
- N(min) : 60.00
- C : 13.0 ±0.2

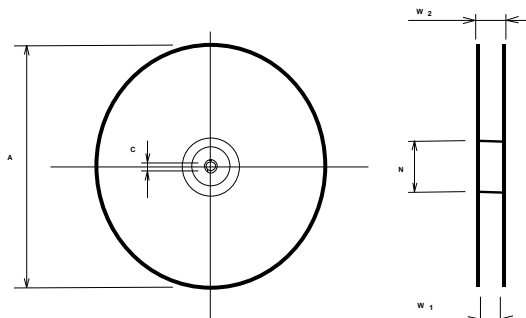

The minimum bending radius is 45 mm.

Microchip Frequency Technology GmbH
Potsdamer Straße 18
D 14 513 TELTOW / Germany
Tel: (+49) 3328 4784-0 / Fax: (+49) 3328 4784-30

Microchip Frequency Technology GmbH reserves the right to make changes to the product(s) and/or information contained herein without notice. No liability is assumed as a result of their use or application. No rights under any patent accompany the sale of any such product(s) or information.

Air reflow temperature conditions

Conditions	Exposure
Average ramp-up rate (30 °C to 217 °C)	less than 3 °C / second
> 100 °C	between 300 and 600 seconds
> 150 °C	between 240 and 500 seconds
> 217 °C	between 30 and 150 seconds
Peak temperature	max. 260 °C
Time within 5 °C of actual peak temperature	between 10 and 30 seconds
Cool-down rate (Peak to 50 °C)	less than 6 °C / second
Time from 30 °C to Peak temperature	no greater than 300 seconds

Chip-mount air reflow profile

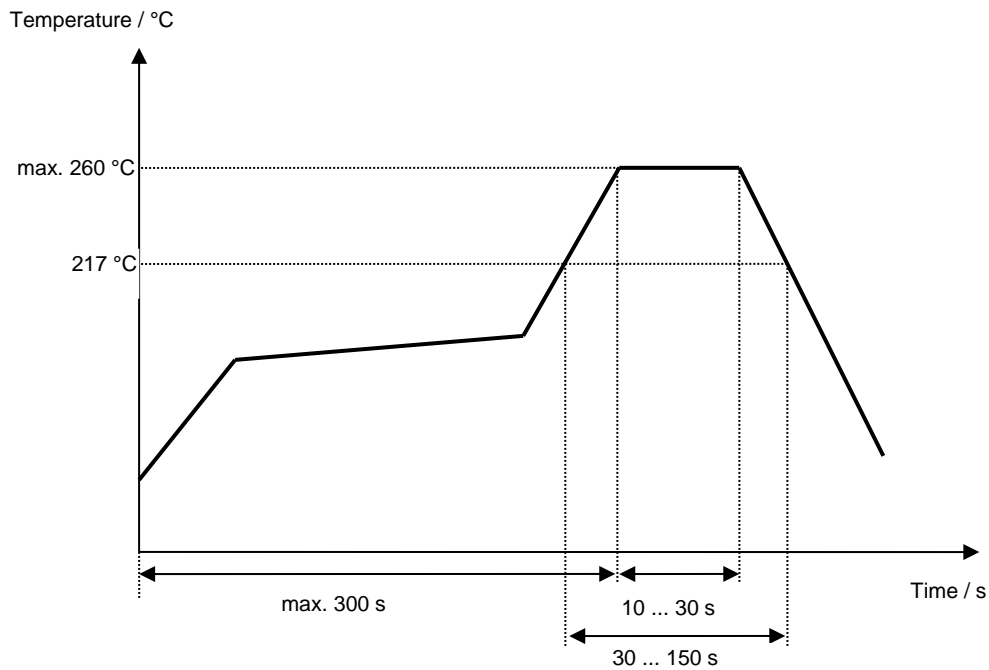

Microchip**Filter specification****TFS931****5/5****History**

Version	Reason of Changes	Name	Date
1.0	- Generation of development specification	A. Molke	08.02.2018
2.0	- Correction of center frequency - Change from development spec to filter spec - Typical values added - Filter characteristic added	A. Molke	24.04.2018
3.0	- Change from filter spec to development spec - Change of package - Typical values removed - Filter characteristic removed	A. Molke	09.08.2018
4.0	- Update of data table	A. Molke	07.01.2019
4.1	- Change from development spec to filter spec - Typical values added - Filter characteristic added	A. Molke	01.03.2019

Microchip Frequency Technology GmbH
Potsdamer Straße 18
D 14 513 TELTOW / Germany
Tel: (+49) 3328 4784-0 / Fax: (+49) 3328 4784-30

Microchip Frequency Technology GmbH reserves the right to make changes to the product(s) and/or information contained herein without notice. No liability is assumed as a result of their use or application. No rights under any patent accompany the sale of any such product(s) or information.