

Microchip

Filter specification

TFS 108

1/5

Measurement condition

| | | |
|--------------------------|-------------------|-----|
| Ambient temperature: | 25 | °C |
| Input power level: | 0 | dBm |
| Terminating impedance: * | | |
| Input: | 836 Ω - 16.1pF | |
| Output: | 827 Ω - 16.1pF | |

Characteristics

Remark:

The reference level for the relative attenuation a_{rel} of the TFS108 is the minimum of the pass band attenuation. This value is defined as the insertion loss a_e . The nominal frequency f_N is fixed at 108.5 MHz without any tolerance. The values of relative attenuation a_{rel} are guaranteed for the whole operating temperature range. The frequency shift of the filter in the operating temperature range is included in the production tolerance scheme.

| D a t a | | typ. value | | tolerance / limit | |
|---|---------------|-------------------|--------------------|--------------------------|---------|
| Insertion loss (reference level) | a_e | 7.5 | dB | max. | 9.5 dB |
| Insertion loss within 2.5dB BW | $a_e + 2.5dB$ | 10 | | max. | 12 dB |
| Nominal frequency | f_N | - | | 108.5 | MHz |
| Passband | PB | | | $f_N \pm 0.5$ | MHz |
| Pass band ripple within PB | | 0.3 | | max. | 2.5 dB |
| Relative attenuation | a_{rel} | | | | |
| $f_N - 0.5$ MHz ... $f_N + 0.5$ MHz | | 2.0 | | max. | 2.5 dB |
| $f_N - 0.8$ MHz ... $f_N - 1.2$ MHz | | 21 | | min. | 13 dB |
| $f_N - 1.2$ MHz ... $f_N - 5.5$ MHz | | 40 | | min. | 34 dB |
| $f_N - 5.5$ MHz ... $f_N - 22.5$ MHz | | 50 | | min. | 40 dB |
| $f_N + 1.5$ MHz ... $f_N + 2.5$ MHz | | 41 | | min. | 20 dB |
| $f_N + 2.5$ MHz ... $f_N + 9.5$ MHz | | 42 | | min. | 30 dB |
| $f_N + 9.5$ MHz ... $f_N + 35.5$ MHz | | 52 | | min. | 40 dB |
| $f_N + 35.5$ MHz ... $f_N + 45.5$ MHz | | 60 | | min. | 45 dB |
| $f_N + 45.5$ MHz ... $f_N + 143.5$ MHz | | 47 | | min. | 40 dB |
| $f_N + 143.5$ MHz ... $f_N + 153.5$ MHz | | 80 | | min. | 45 dB |
| $f_N + 153.5$ MHz ... $f_N + 160$ MHz | | 80 | | min. | 40 dB |
| Group delay ripple within PB | GDR | 200 | | max. | 1000 ns |
| IIP3 | | - | | min. | 30 dBm |
| Return loss within PB | | 12 | | min. | 10 dB |
| Input power | | - | | max | 10 dBm |
| Operating temperature range | OTR | | | - 40 °C ... + 85°C | |
| Operable temperature range | | | | - 55 °C ... + 85°C | |
| Storage temperature range | | | | - 55 °C ... + 85°C | |
| Temperature coefficient of frequency | TC_f ** | -0.036 | ppm/K ² | | |

*) The terminating impedances depend on parasitics and q-values of matching elements and the board used, and are to be understood as reference values only. Should there be additional questions do not hesitate to ask for an application note or contact our design team.

**) $\Delta f(\text{Hz}) = TC_f(\text{ppm/K}^2) \times (T-T_0)^2 \times f_{T0}(\text{MHz})$.

Generated:

Checked / Approved:

Microchip Frequency Technology GmbH
Potsdamer Straße 18
D 14 513 TELTOW / Germany
Tel: (+49) 3328 4784-0 / Fax: (+49) 3328 4784-30

Microchip Frequency Technology GmbH reserves the right to make changes to the product(s) and/or information contained herein without notice. No liability is assumed as a result of their use or application. No rights under any patent accompany the sale of any such product(s) or information.

Filter characteristic

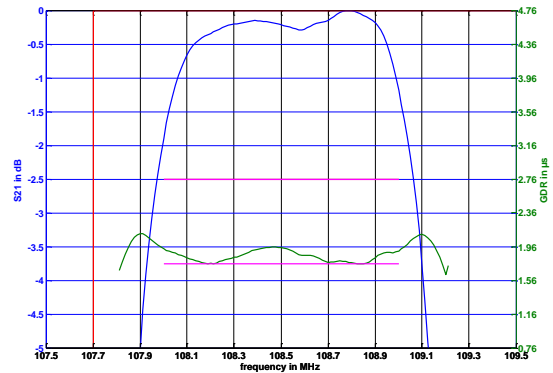
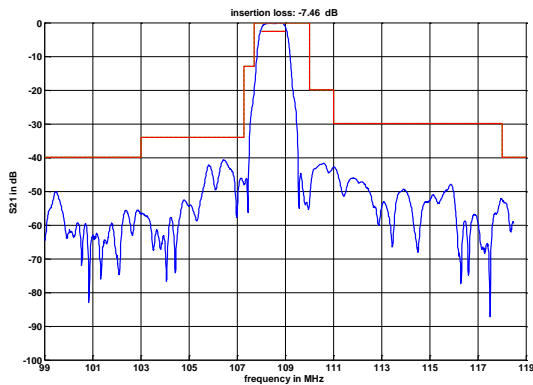

Construction and pin connection

(All dimensions in mm)

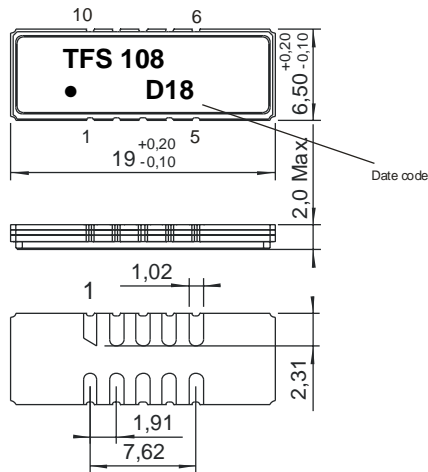

- 1 Input RF Return
- 2 Ground
- 3 Ground
- 4 Ground
- 5 Output
- 6 Output RF Return
- 7 Ground
- 8 Ground
- 9 Ground
- 10 Input

Date code: Year + week
 E 2014
 F 2015
 G 2016
 ...

50 Ω Test circuit

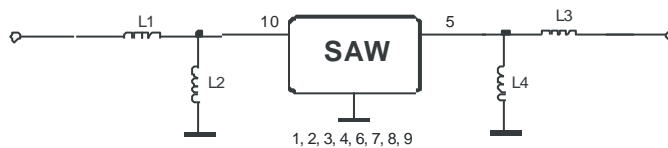

Microchip Frequency Technology GmbH
 Potsdamer Straße 18
 D 14 513 TELTOW / Germany
 Tel: (+49) 3328 4784-0 / Fax: (+49) 3328 4784-30

Microchip Frequency Technology GmbH reserves the right to make changes to the product(s) and/or information contained herein without notice. No liability is assumed as a result of their use or application. No rights under any patent accompany the sale of any such product(s) or information.

Stability characteristics, reliability

After the following tests the filter shall meet the whole specification:

1. Shock: 500g, 1 ms, half sine wave, 3 shocks each plane;
DIN IEC 68 T2 - 27
2. Vibration: 10 Hz to 500 Hz, 0,35 mm or 5 g respectively, 1 octave per min, 10 cycles per plane, 3 planes;
DIN IEC 68 T2 - 6
3. Change of temperature: -55 °C to 125°C / 15 min. each / 100 cycles
DIN IEC 68 part 2 – 14 Test N
4. Resistance to solder heat (reflow): reflow possible: three times max.;
for temperature conditions refer to the attached "Air reflow temperature conditions" on page 4;
5. ESD ANSI/ESD S20.20-1999, class 1A for HBM

This filter is RoHS compliant (2011/65/EU)

Packing

- Tape & Reel: IEC 286 – 3, with exception of value for N and minimum bending radius;
tape type II, embossed carrier tape with top cover tape on the upper side;
- | | |
|---|-------------|
| max. pieces of filters per reel: | 2000 |
| reel of empty components at start: | min. 300 mm |
| reel of empty components at start including leader: | min. 500 mm |
| trailer: | min. 300 mm |

Tape (all dimensions in mm)

- W : 32,00 ± 0,3
- Po : 4,00 ± 0,1
- Do : 1,50 +0,1/-0
- E : 1,75 ± 0,1
- F : 14,20 ± 0,1
- G(min) :
- P2 : 2,00 ± 0,1
- P1 : 12,00 ± 0,1
- D1(min) : 2,00
- Ao : 7,10 ± 0,1
- Bo : 19,60 ± 0,1
- Ct : 25,5 ± 0,1

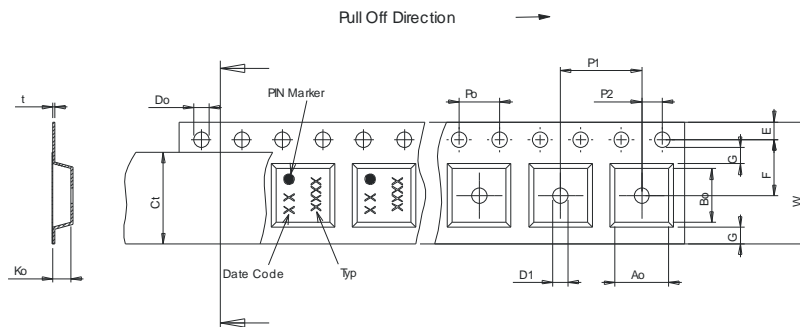

Reel (all dimensions in mm)

- A : 330
- W1 : 32,4 +2/-0
- W2(max) : 38,4
- N(min) : 100
- C : 13,0 +0,5/-0,2

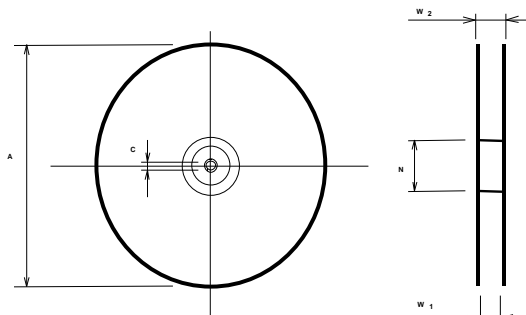

The minimum bending radius is 45 mm.

Microchip Frequency Technology GmbH
Potsdamer Straße 18
D 14 513 TELTOW / Germany
Tel: (+49) 3328 4784-0 / Fax: (+49) 3328 4784-30

Microchip Frequency Technology GmbH reserves the right to make changes to the product(s) and/or information contained herein without notice. No liability is assumed as a result of their use or application. No rights under any patent accompany the sale of any such product(s) or information.

Air reflow temperature conditions

| Conditions | Exposure |
|--|-----------------------------|
| Average ramp-up rate (30°C to 217°C) | less than 3°C/second |
| > 100°C | between 300 and 600 seconds |
| > 150°C | between 240 and 500 seconds |
| > 217°C | between 30 and 150 seconds |
| Peak temperature | max. 260°C |
| Time within 5°C of actual peak temperature | between 10 and 30 seconds |
| Cool-down rate (Peak to 50°C) | less than 6°C/second |
| Time from 30°C to Peak temperature | no greater than 300 seconds |

Chip-mount air reflow profile

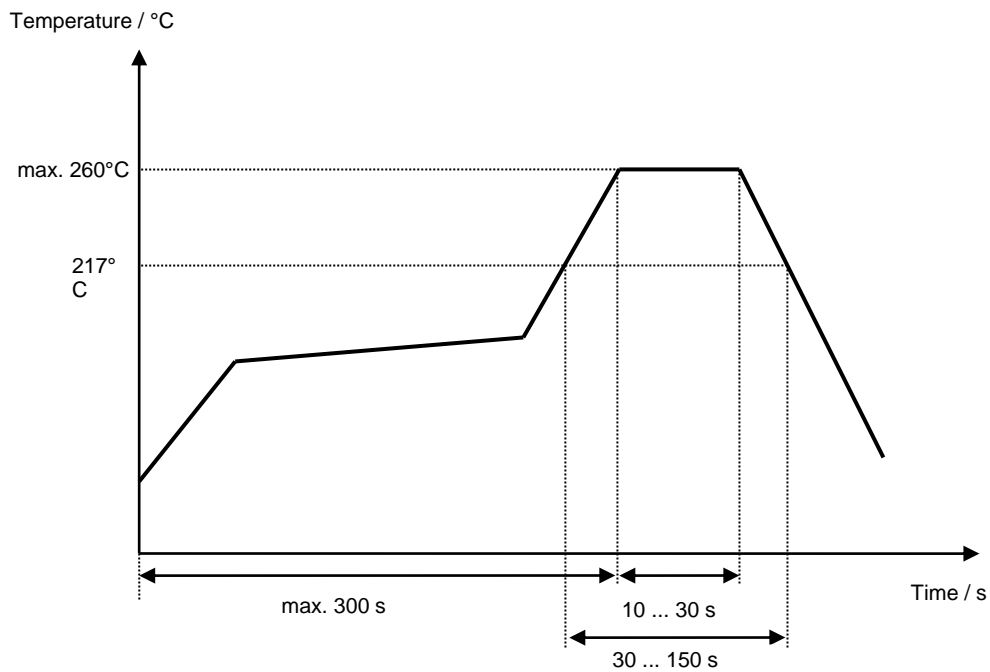

Microchip Frequency Technology GmbH
Potsdamer Straße 18
D 14 513 TELTOW / Germany
Tel: (+49) 3328 4784-0 / Fax: (+49) 3328 4784-30

Microchip Frequency Technology GmbH reserves the right to make changes to the product(s) and/or information contained herein without notice. No liability is assumed as a result of their use or application. No rights under any patent accompany the sale of any such product(s) or information.

Microchip**Filter specification****TFS 108****5/5**

History

| Version | Reason of changes | Name | Date |
|----------------|--|-------------|-------------|
| 1.0 | - Generation of development specification | TCUK | 26.07.2013 |
| 1.1 | - Change to Filter Spec. Added characteristic plots. | TCUK | 30.01.2014 |

Microchip Frequency Technology GmbH
Potsdamer Straße 18
D 14 513 TELTOW / Germany
Tel: (+49) 3328 4784-0 / Fax: (+49) 3328 4784-30

Microchip Frequency Technology GmbH reserves the right to make changes to the product(s) and/or information contained herein without notice. No liability is assumed as a result of their use or application. No rights under any patent accompany the sale of any such product(s) or information.