

CORAL-IP-OW

115 + 6° oval beam

SPECIFICATION:

Dimensions	74.5 x 44.5
Height	32 mm
Fastening	pin, screw
Ingress protection classes	IP66,IP67
ROHS compliant	yes ⓘ

MATERIALS:

Component	Type	Material	Colour	Finish	Length (mm)
CORAL-IP-OW	Single lens	PC-ABS			
CORAL-IP-OW-SEAL	Seal	Silicone	white		

ORDERING INFORMATION:

Component	Qty in box	MOQ	MPQ	Box weight (kg)
CS19838_CORAL-IP-OW » Box size: 480 x 280 x 260 mm	180	180	180	6.4

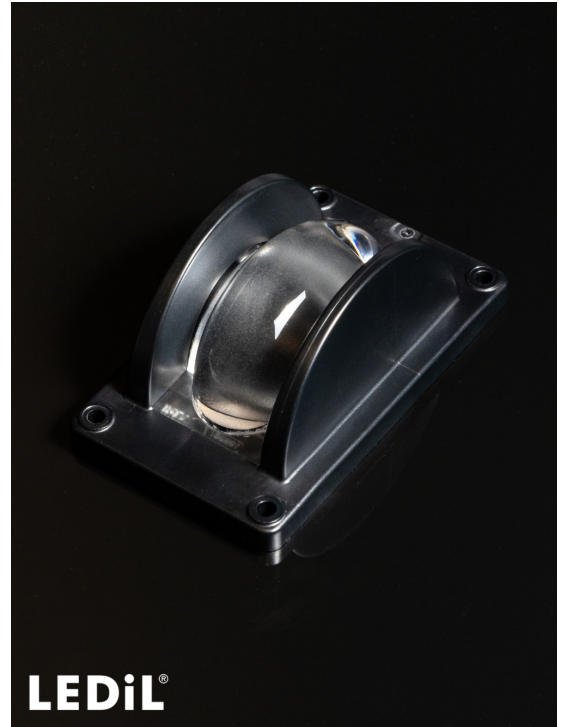

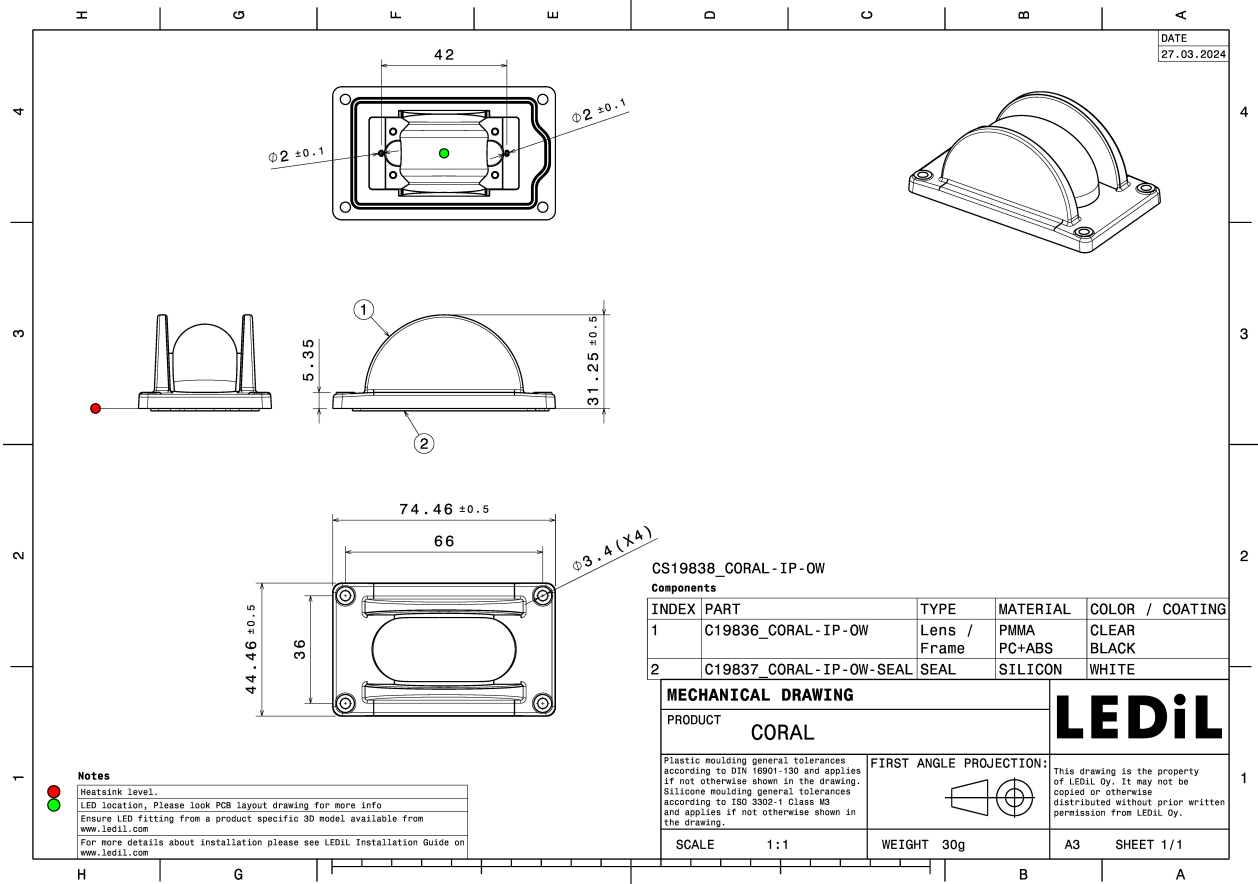

See also our general installation guide: www.ledil.com/installation_guide

OPTICAL RESULTS (SIMULATED):



LED CSP 2727 (BXCP)
FWHM / FWTM 111.0 + 8.0° / 154.0 + 14.0°
Efficiency 53 %
Peak intensity 1.8 cd/lm
LEDs/each optic 6
Light colour/type White
Required components:

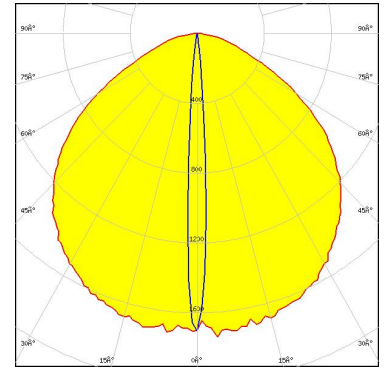

Light distribution files



LED SMD 3838 RGBW 3V
FWHM / FWTM 110.0 + 8.0° / 150.0 + 16.0°
Efficiency 56 %
Peak intensity 1.8 cd/lm
LEDs/each optic 4
Light colour/type RGBW
Required components:

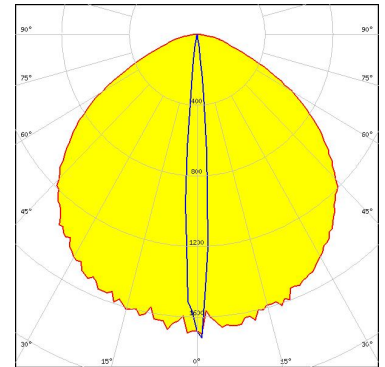

Light distribution files



LED CLR6A-TKW
FWHM / FWTM 106.0 + 8.0° / 146.0 + 16.0°
Efficiency 56 %
Peak intensity 1.9 cd/lm
LEDs/each optic 4
Light colour/type RGBW
Required components:

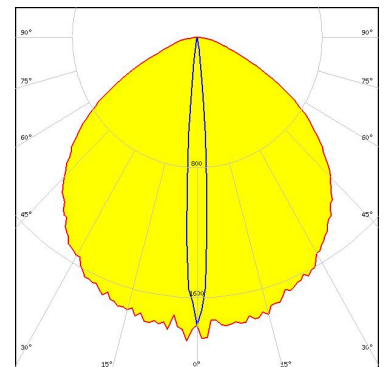

Light distribution files

OPTICAL RESULTS (SIMULATED):



LED J Series 5050B 6V K Class
FWHM / FWTM 113.0 + 10.0° / 154.0 + 18.0°
Efficiency 53 %
Peak intensity 1.7 cd/lm
LEDs/each optic 1
Light colour/type White
Required components:

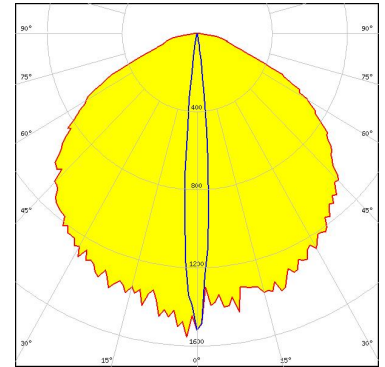

Light distribution files



LED XB-D
FWHM / FWTM 122.0 + 6.0° / 164.0 + 14.0°
Efficiency 48 %
Peak intensity 1.8 cd/lm
LEDs/each optic 4
Light colour/type RGBW
Required components:

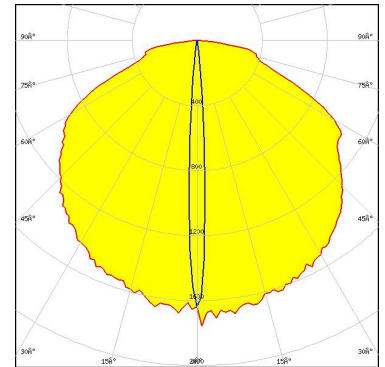

Light distribution files



LED XE-G
FWHM / FWTM 121.0 + 6.0° / 160.0 + 14.0°
Efficiency 52 %
Peak intensity 1.9 cd/lm
LEDs/each optic 3
Light colour/type Red
Required components:

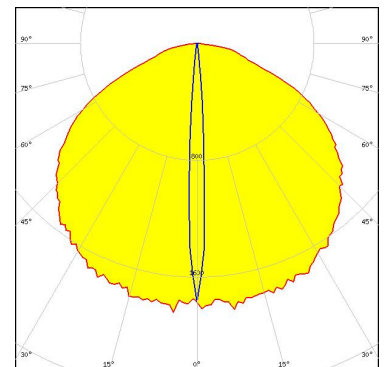

Light distribution files

OPTICAL RESULTS (SIMULATED):



LED XE-G
 FWHM / FWTM 116.0 + 6.0° / 162.0 + 12.0°
 Efficiency 53 %
 Peak intensity 2.1 cd/lm
 LEDs/each optic 4
 Light colour/type White
 Required components:

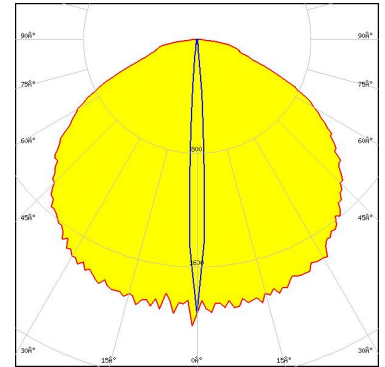

Light distribution files



LED XE-G
 FWHM / FWTM 118.0 + 6.0° / 160.0 + 14.0°
 Efficiency 53 %
 Peak intensity 1.9 cd/lm
 LEDs/each optic 6
 Light colour/type Red
 Required components:

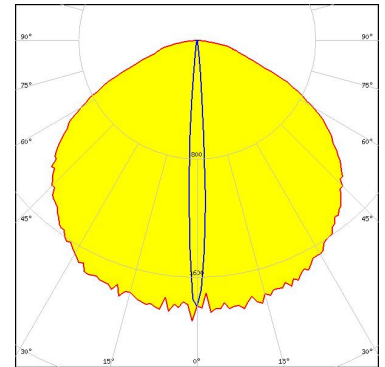

Light distribution files



LED XE-G
 FWHM / FWTM 119.0 + 6.0° / 161.0 + 14.0°
 Efficiency 52 %
 Peak intensity 1.9 cd/lm
 LEDs/each optic 4
 Light colour/type RGBW
 Required components:

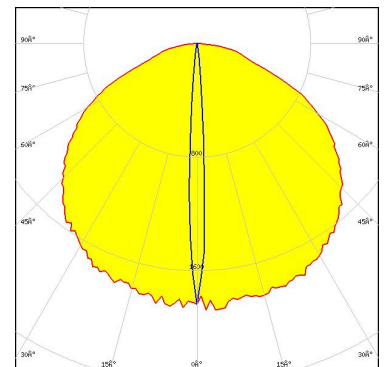

Light distribution files

OPTICAL RESULTS (SIMULATED):



LED XE-G
FWHM / FWTM 117.0 + 6.0° / 159.0 + 14.0°
Efficiency 53 %
Peak intensity 2 cd/lm
LEDs/each optic 7
Light colour/type Red
Required components:

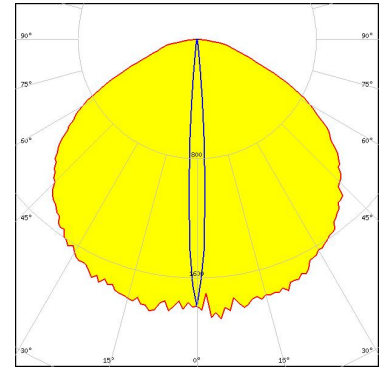

Light distribution files



LED XE-G
FWHM / FWTM 110.0 + 10.0° / 156.0 + 18.0°
Efficiency 55 %
Peak intensity 1.3 cd/lm
LEDs/each optic 30
Light colour/type Red
Required components:

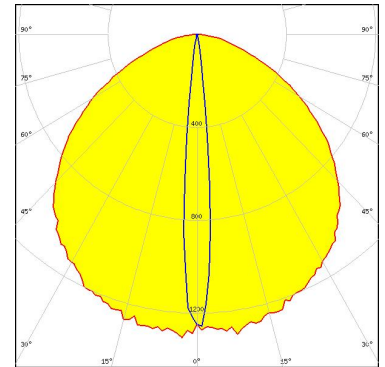

Light distribution files



LED XE-G
FWHM / FWTM 116.0 + 6.0° / 161.0 + 14.0°
Efficiency 52 %
Peak intensity 1.8 cd/lm
LEDs/each optic 5
Light colour/type White
Required components:

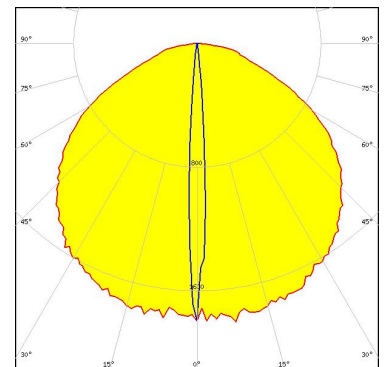

Light distribution files

OPTICAL RESULTS (SIMULATED):



LED XE-G
FWHM / FWTM 120.0 + 6.0° / 164.0 + 13.0°
Efficiency 52 %
Peak intensity 2.1 cd/lm
LEDs/each optic 1
Light colour/type White
Required components:

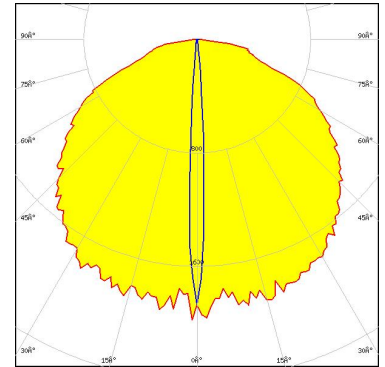

Light distribution files



LED XE-G
FWHM / FWTM 118.0 + 6.0° / 162.0 + 13.0°
Efficiency 52 %
Peak intensity 1.9 cd/lm
LEDs/each optic 6
Light colour/type White
Required components:

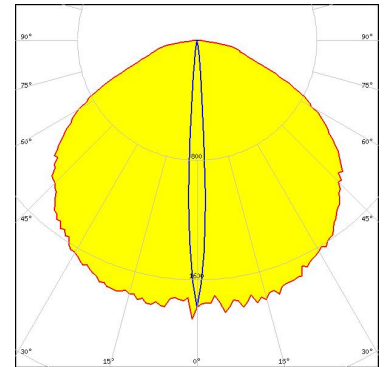

Light distribution files



LED XE-G
FWHM / FWTM 117.0 + 6.0° / 162.0 + 14.0°
Efficiency 52 %
Peak intensity 1.9 cd/lm
LEDs/each optic 7
Light colour/type White
Required components:

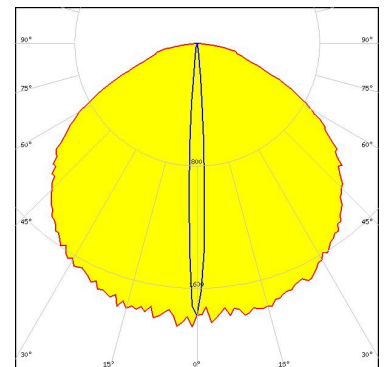

Light distribution files

OPTICAL RESULTS (SIMULATED):



LED XE-G
 FWHM / FWTM 111.0 + 10.0° / 158.0 + 18.0°
 Efficiency 54 %
 Peak intensity 1.3 cd/lm
 LEDs/each optic 30
 Light colour/type White
 Required components:

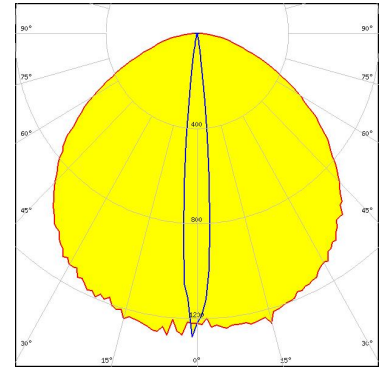

Light distribution files



LED XE-G
 FWHM / FWTM 102.0 + 6.0° / 150.0 + 14.0°
 Efficiency 55 %
 Peak intensity 1.9 cd/lm
 LEDs/each optic 15
 Light colour/type Red
 Required components:

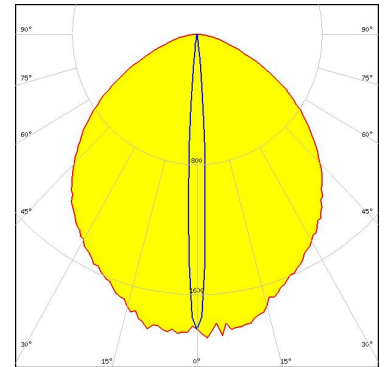

Light distribution files



LED XM-L RGBW (XMLDCL HD)
 FWHM / FWTM 123.0 + 9.0° / 145.0 + 16.0°
 Efficiency 54 %
 Peak intensity 1.6 cd/lm
 LEDs/each optic 1
 Light colour/type RGBW
 Required components:

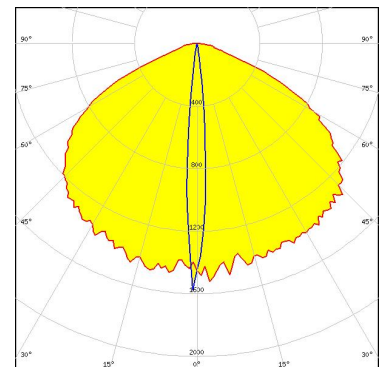

Light distribution files

OPTICAL RESULTS (SIMULATED):



LED XM-L RGBW (XMLDCL HI)
FWHM / FWTM 104.0 + 8.0° / 148.0 + 16.0°
Efficiency 56 %
Peak intensity 1.8 cd/lm
LEDs/each optic 4
Light colour/type RGBW
Required components:

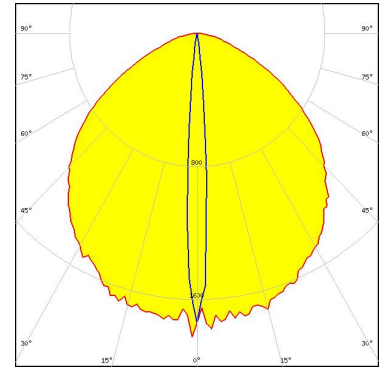

Light distribution files



LED XM-L RGBW (XMLDCL HI)
FWHM / FWTM 110.0 + 8.0° / 153.0 + 15.0°
Efficiency 53 %
Peak intensity 1.9 cd/lm
LEDs/each optic 1
Light colour/type RGBW
Required components:

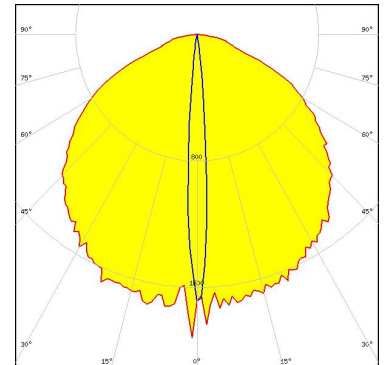

Light distribution files



LED XN-P Color
FWHM / FWTM 107.0 + 8.0° / 144.0 + 14.0°
Efficiency 57 %
Peak intensity 2 cd/lm
LEDs/each optic 4
Light colour/type RGBW
Required components:

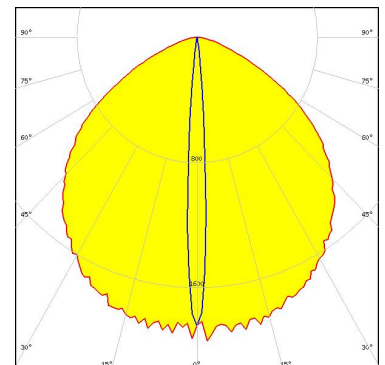

Light distribution files

OPTICAL RESULTS (SIMULATED):



LED XP-E2
FWHM / FWTM 107.0 + 6.0° / 158.0 + 13.0°
Efficiency 54 %
Peak intensity 2.2 cd/lm
LEDs/each optic 1
Light colour/type White
Required components:

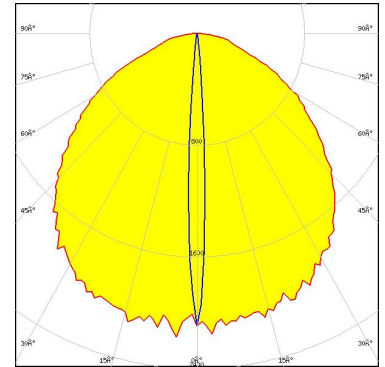

Light distribution files



LED XP-E2
FWHM / FWTM 106.0 + 6.0° / 148.0 + 12.0°
Efficiency 55 %
Peak intensity 2.2 cd/lm
LEDs/each optic 4
Light colour/type White
Required components:

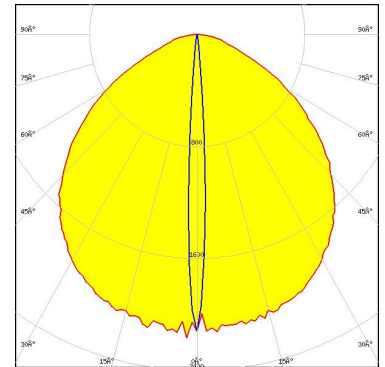

Light distribution files



LED XP-G2
FWHM / FWTM 117.0 + 6.0° / 161.0 + 13.0°
Efficiency 52 %
Peak intensity 2.1 cd/lm
LEDs/each optic 1
Light colour/type White
Required components:

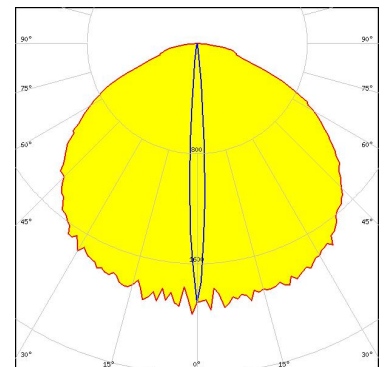

Light distribution files

OPTICAL RESULTS (SIMULATED):



LED XP-L RGBW HI
FWHM / FWTM 114.0 + 8.0° / 158.0 + 14.0°
Efficiency 53 %
Peak intensity 1.8 cd/lm
LEDs/each optic 4
Light colour/type RGBW
Required components:

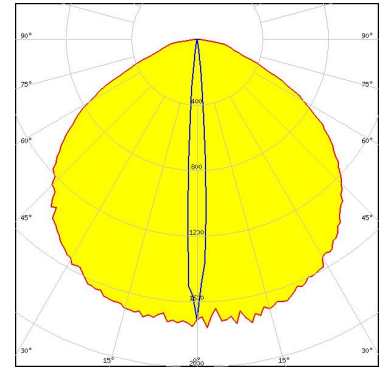

Light distribution files



LED XQ-E HI
FWHM / FWTM 117.0 + 6.0° / 162.0 + 13.0°
Efficiency 51 %
Peak intensity 1.9 cd/lm
LEDs/each optic 4
Light colour/type RGBW
Required components:

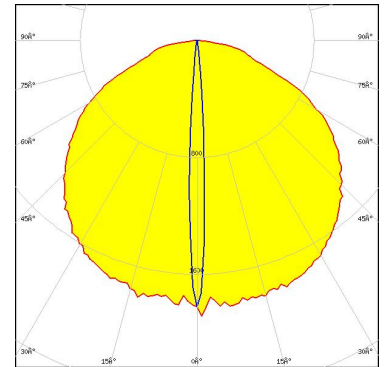

Light distribution files



LED LUXEON CZ
FWHM / FWTM 115.0 + 6.0° / 159.0 + 13.0°
Efficiency 54 %
Peak intensity 2.2 cd/lm
LEDs/each optic 1
Light colour/type Red
Required components:

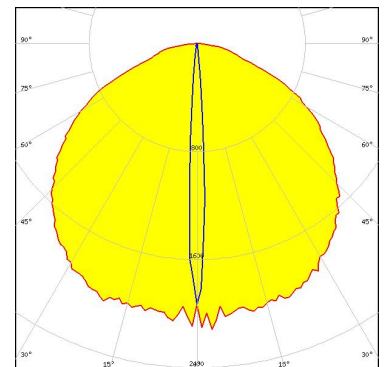

Light distribution files

OPTICAL RESULTS (SIMULATED):



LED LUXEON CZ
 FWHM / FWTM 115.0 + 6.0° / 157.0 + 12.0°
 Efficiency 53 %
 Peak intensity 2.2 cd/lm
 LEDs/each optic 4
 Light colour/type RGBW
 Required components:

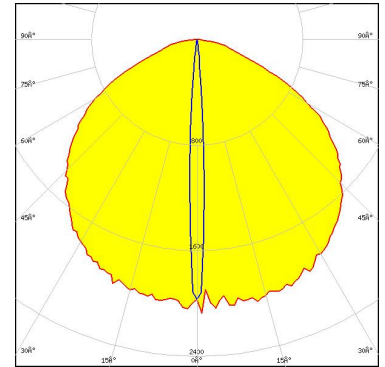

Light distribution files



LED LUXEON CZ
 FWHM / FWTM 115.0 + 6.0° / 160.0 + 12.0°
 Efficiency 53 %
 Peak intensity 2.1 cd/lm
 LEDs/each optic 1
 Light colour/type White
 Required components:

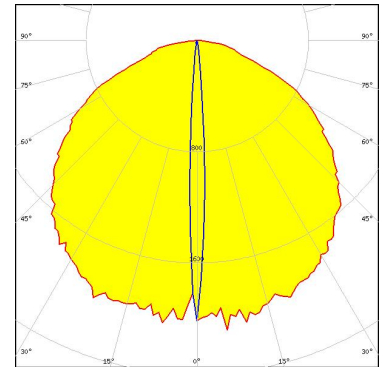

Light distribution files



LED LUXEON HL4Z
 FWHM / FWTM 115.0 + 8.0° / 156.0 + 14.0°
 Efficiency 53 %
 Peak intensity 1.8 cd/lm
 LEDs/each optic 4
 Light colour/type White
 Required components:

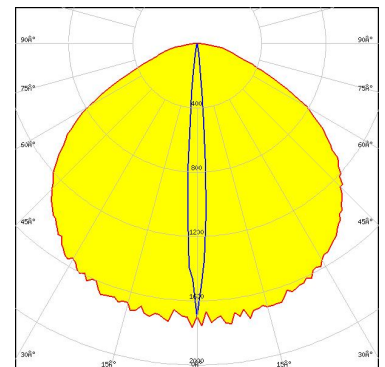

Light distribution files

OPTICAL RESULTS (SIMULATED):



LED LUXEON Rubix
FWHM / FWTM 119.0 + 5.0° / 160.5 + 11.0°
Efficiency 50 %
Peak intensity 2.2 cd/lm
LEDs/each optic 4
Light colour/type RGBW
Required components:

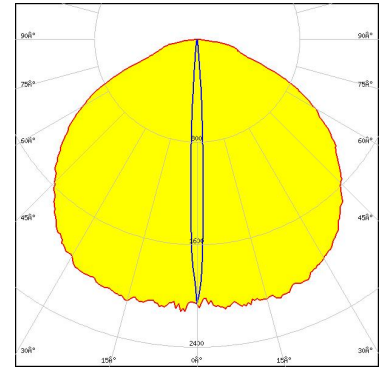

Light distribution files



LED NCSxE17A
FWHM / FWTM 115.0 + 6.0° / 160.0 + 12.0°
Efficiency 49 %
Peak intensity 1.9 cd/lm
LEDs/each optic 4
Light colour/type RGBW
Required components:

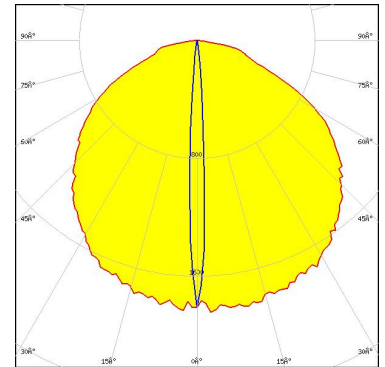

Light distribution files



LED NCSxx19B
FWHM / FWTM 120.0 + 6.0° / 162.0 + 14.0°
Efficiency 50 %
Peak intensity 1.7 cd/lm
LEDs/each optic 4
Light colour/type RGBW
Required components:

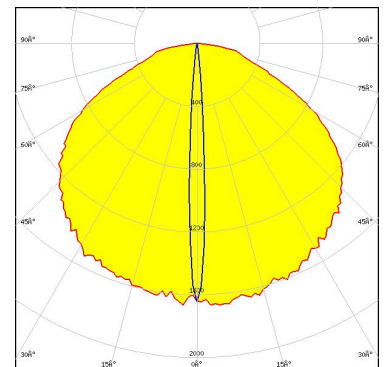

Light distribution files

OPTICAL RESULTS (SIMULATED):

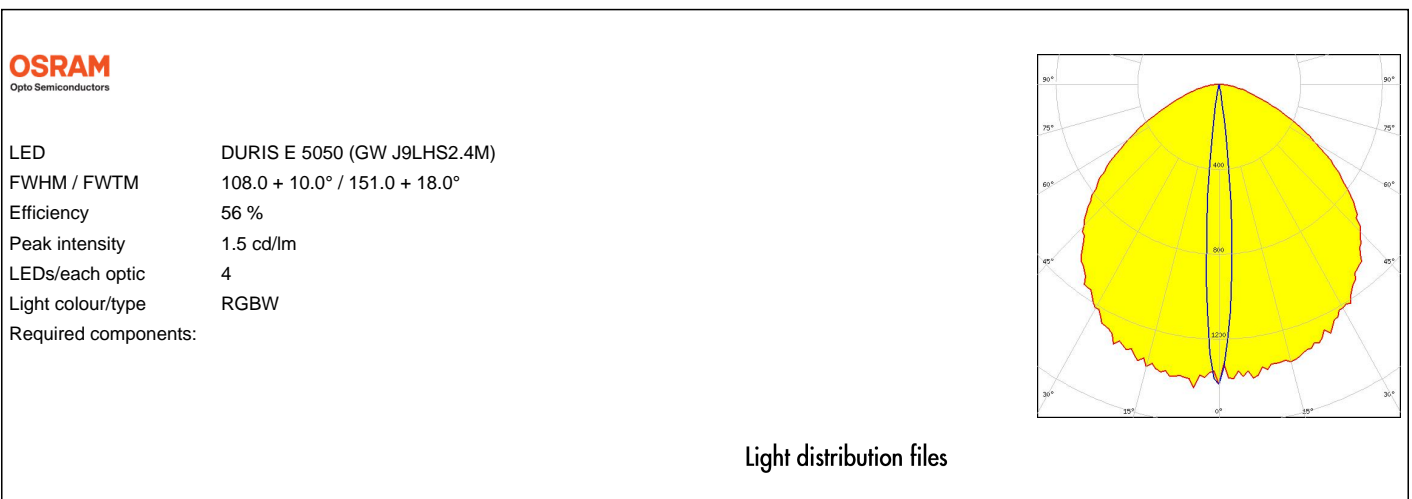
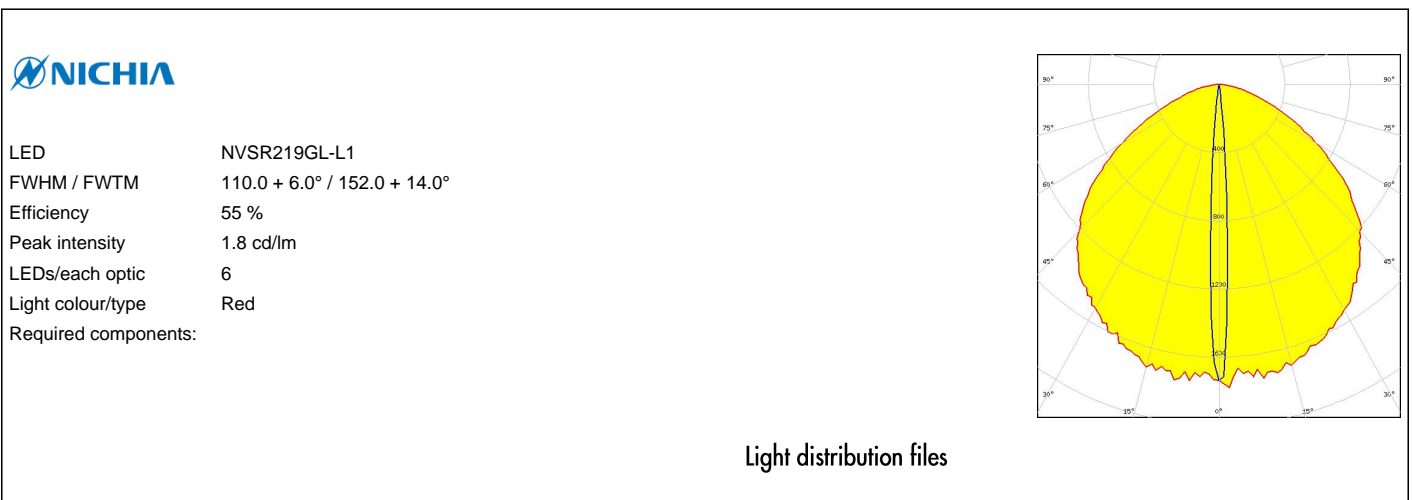
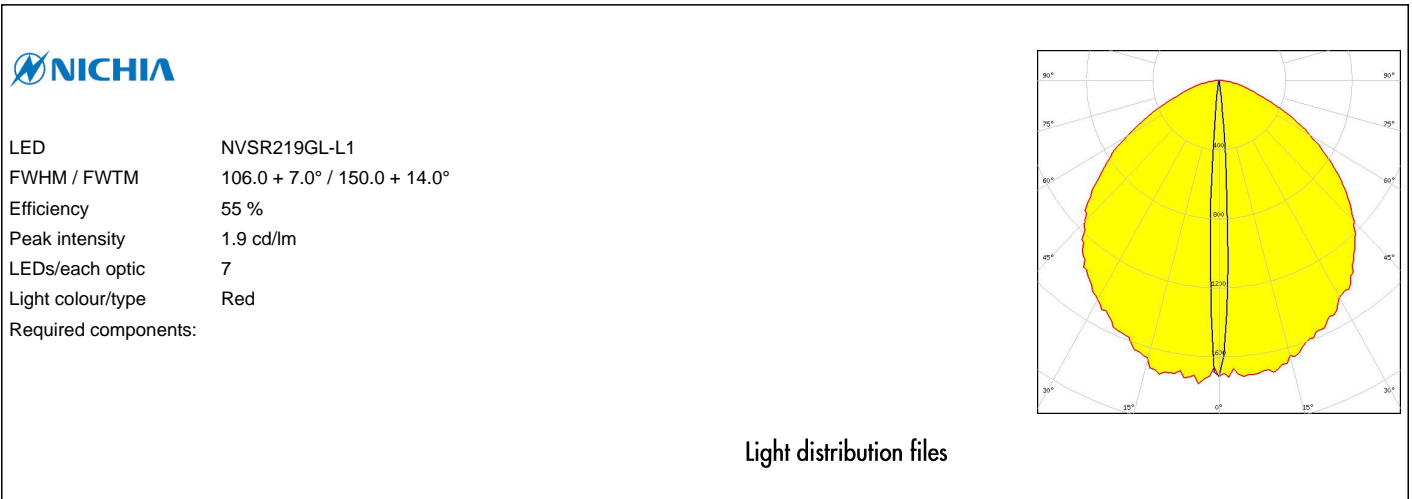

OPTICAL RESULTS (SIMULATED):

OSRAM
Opto Semiconductors

LED OSLON Pure 1414
FWHM / FWTM 112.0 + 6.0° / 158.0 + 12.0°
Efficiency 53 %
Peak intensity 2.3 cd/lm
LEDs/each optic 4
Light colour/type RGBW
Required components:

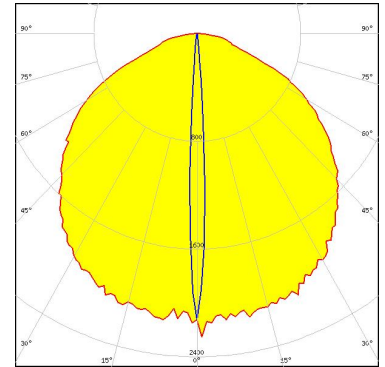

Light distribution files

OSRAM
Opto Semiconductors

LED OSLON SSL 150
FWHM / FWTM 126.0 + 6.0° / 159.0 + 12.0°
Efficiency 52 %
Peak intensity 1.9 cd/lm
LEDs/each optic 4
Light colour/type White
Required components:

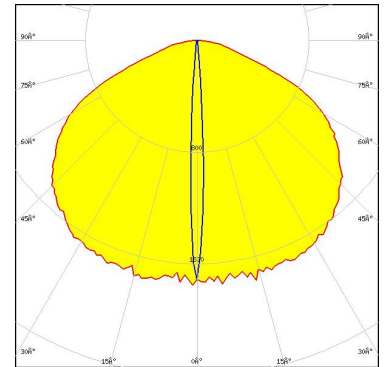

Light distribution files

OSRAM
Opto Semiconductors

LED OSLON SSL 150
FWHM / FWTM 133.0 + 6.0° / 157.0 + 12.0°
Efficiency 51 %
Peak intensity 1.6 cd/lm
LEDs/each optic 4
Light colour/type Red
Required components:

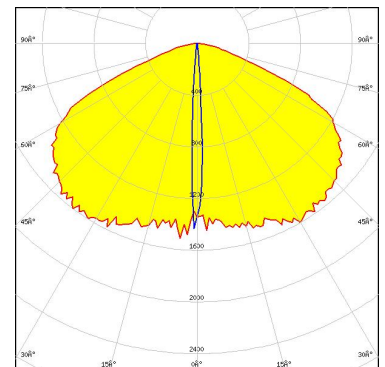

Light distribution files

OPTICAL RESULTS (SIMULATED):

OSRAM
Opto Semiconductors

LED OSLON SSL 150
 FWHM / FWTM 132.0 + 6.0° / 156.0 + 13.0°
 Efficiency 51 %
 Peak intensity 1.5 cd/lm
 LEDs/each optic 6
 Light colour/type Red
 Required components:

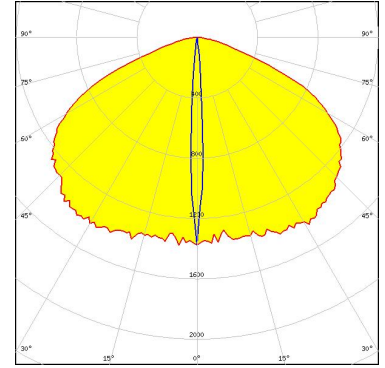

Light distribution files

OSRAM
Opto Semiconductors

LED OSLON SSL 150
 FWHM / FWTM 130.0 + 6.0° / 153.0 + 14.0°
 Efficiency 52 %
 Peak intensity 1.4 cd/lm
 LEDs/each optic 8
 Light colour/type Red
 Required components:

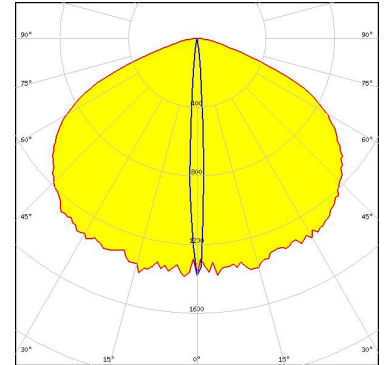

Light distribution files

OSRAM
Opto Semiconductors

LED OSLON SSL 150
 FWHM / FWTM 118.0 + 6.0° / 154.0 + 13.0°
 Efficiency 53 %
 Peak intensity 1.8 cd/lm
 LEDs/each optic 7
 Light colour/type White
 Required components:

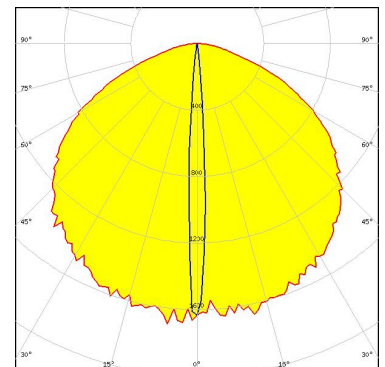

Light distribution files

OPTICAL RESULTS (SIMULATED):

OSRAM
Opto Semiconductors

LED OSLON SSL 150
FWHM / FWTM 131.0 + 6.0° / 162.0 + 12.0°
Efficiency 51 %
Peak intensity 1.9 cd/lm
LEDs/each optic 1
Light colour/type White
Required components:

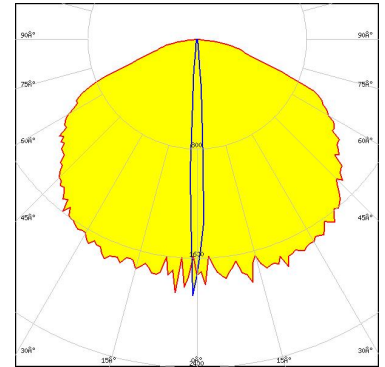

Light distribution files

OSRAM
Opto Semiconductors

LED OSLON SSL 150
FWHM / FWTM 137.0 + 6.0° / 161.0 + 12.0°
Efficiency 49 %
Peak intensity 1.6 cd/lm
LEDs/each optic 1
Light colour/type Red
Required components:

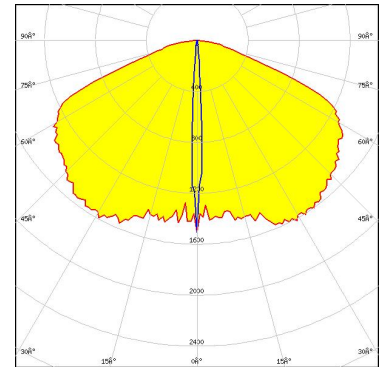

Light distribution files

OSRAM
Opto Semiconductors

LED OSLON SSL 150
FWHM / FWTM 132.0 + 6.0° / 154.0 + 14.0°
Efficiency 51 %
Peak intensity 1.5 cd/lm
LEDs/each optic 7
Light colour/type Red
Required components:

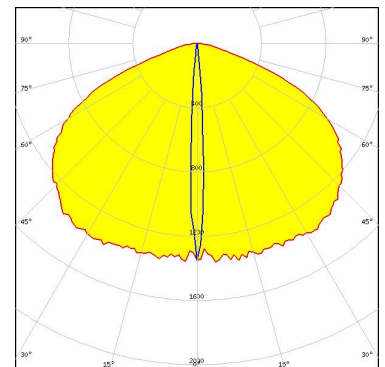

Light distribution files

OPTICAL RESULTS (SIMULATED):

OSRAM
Opto Semiconductors

LED OSLON SSL 150
FWHM / FWTM 119.0 + 6.0° / 156.0 + 14.0°
Efficiency 52 %
Peak intensity 1.8 cd/lm
LEDs/each optic 6
Light colour/type White
Required components:

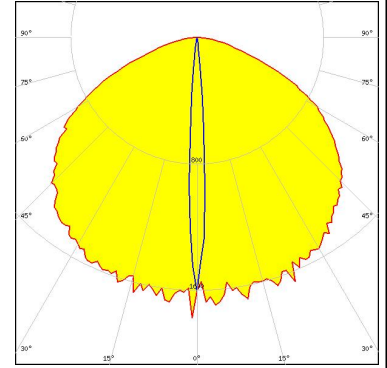

Light distribution files

OSRAM
Opto Semiconductors

LED OSTAR Stage (S2WN)
FWHM / FWTM 108.0 + 8.0° / 146.0 + 14.0°
Efficiency 56 %
Peak intensity 1.9 cd/lm
LEDs/each optic 4
Light colour/type RGBW
Required components:

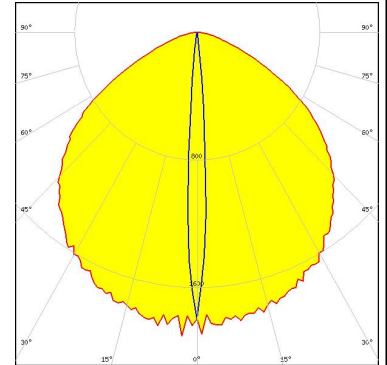

Light distribution files

GENERAL INFORMATION:

NOTE: The typical beam angle will be changed by different color, chip size and chip position tolerance. The typical total beam angle is the full angle measured where the luminous intensity is half of the peak value.

MATERIALS:

As part of our continuous research and improvement processes, and to ensure the best possible quality and availability of our products, LEDiL reserves the right to change material grades without notice.

PRODUCT DATA USER AGREEMENT AND DISCLAIMER:

The measured data in the provided downloadable LEDiL Product Datasheets and Mechanical 2D-Drawings is rounded and provided as reference for planning. LEDiL Oy's optical specifications have been verified by conducting performance testing of the products in accordance with the company's quality system. The reported data are averaged results of multiple measurements with typical variation. LEDiL Oy reserves the right to without prior notification make changes and improvements to its products.

LEDiL Oy assumes neither warranty, nor guarantee nor any other liability of any kind for the contents and correctness of the provided data. The provided data has been generated with highest diligence but the provided data may in reality not represent the complete possible variation range of all intrinsic parameters. Therefore, in certain cases a deviation from the provided data could occur.

LEDiL Oy reserves the right to undertake technical changes of its products without further notification which could lead to changes in the provided data. LEDiL Oy assumes no liability of any kind for the possible deviation from any provided data or any other damage resulting from the usage of the provided data.

The user agrees to this disclaimer and user agreement with the download or usage of the provided files.

LEDiL Oy

Joensuunkatu 7
FI-24100 SALO
Finland

LEDiL Inc.

228 West Page Street
Suite D
Sycamore IL 60178
USA

Ledil Optics Technology (Shenzhen) Co., Ltd.

405 , Block B
Casic Motor Building
Shenzhen 518057
P.R.CHINA

Local sales and technical support

[www.ledil.com/
where_to_buy](http://www.ledil.com/where_to_buy)

Shipping locations

Poznan, Poland
Hong Kong, China

Distribution Partners

[www.ledil.com/
where_to_buy](http://www.ledil.com/where_to_buy)

Mouser Electronics

Authorized Distributor

Click to View Pricing, Inventory, Delivery & Lifecycle Information:

[Ledil:](#)

[CS19838_CORAL-IP-OW](#)