

Zener Diode Silicon Epitaxial Planar

XCEZ series

1. Applications

- (1) Automotive
- (2) Voltage surge protection

2. Features

- (1) AEC-Q101 qualified
- (2) Small package
- (3) The typical voltage of VZ is accorded to E24 series.

3. Packaging and Internal Circuit

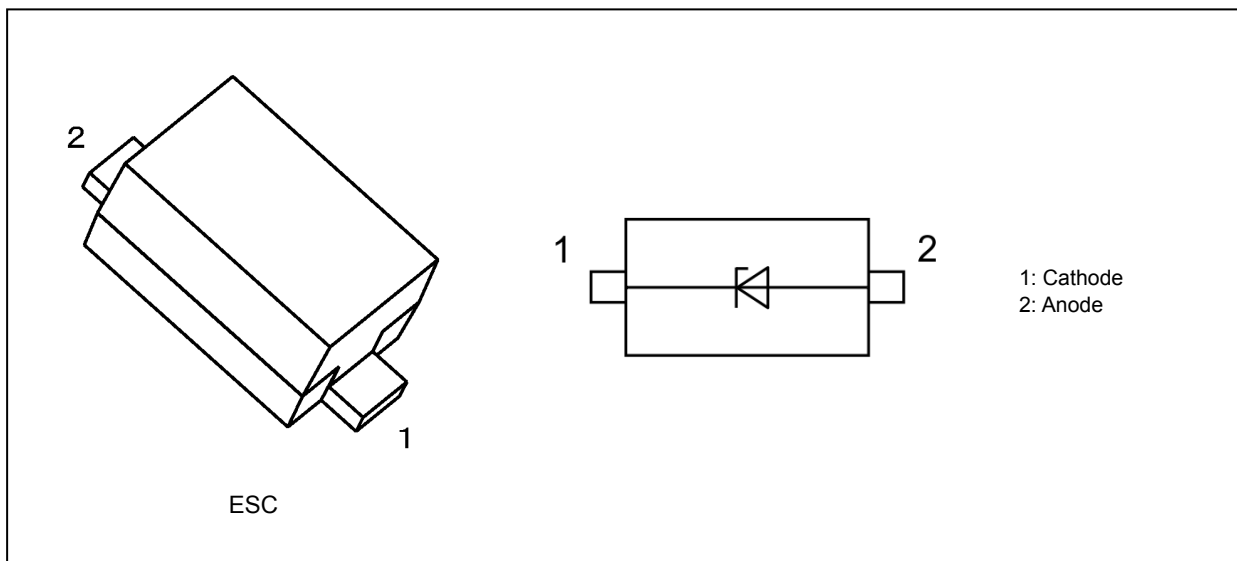

4. Absolute Maximum Ratings 1 (Note) (Unless otherwise specified, $T_a = 25\text{ }^\circ\text{C}$)

Characteristics	Symbol	Note	Rating	Unit
Power dissipation	P_D	(Note 1)	150	mW
		(Note 2)	300	
Junction temperature	T_j		150	$^\circ\text{C}$
Storage temperature	T_{stg}		-55 to 150	

Note: Using continuously under heavy loads (e.g. the application of high temperature/current/voltage and the significant change in temperature, etc.) may cause this product to decrease in the reliability significantly even if the operating conditions (i.e. operating temperature/current/voltage, etc.) are within the absolute maximum ratings.

Please design the appropriate reliability upon reviewing the Toshiba Semiconductor Reliability Handbook ("Handling Precautions"/"Derating Concept and Methods") and individual reliability data (i.e. reliability test report and estimated failure rate, etc).

Note 1: Mounted on a glass epoxy circuit board of 20 mm × 20 mm, pad dimensions of 16 mm²

Note 2: Mounted on a glass epoxy circuit board of 25.4 mm × 25.4 mm × 1.6 mm, Cu pad: 645 mm²

Start of commercial production

2025-06

5. Absolute Maximum Ratings 2 (Note) (Unless otherwise specified, $T_a = 25\text{ }^\circ\text{C}$)

Type No.	Electrostatic discharge voltage IEC61000-4-2 (Contact, Air) $V_{ESD}(kV)$ (Note 1)	Electrostatic discharge voltage ISO10605 (Cotact, Air) $V_{ESD}(kV)$ (Note 2)	Peak pulse power $P_{PK}(W)$ (Note 3)	Peak pulse current $I_{PP}(A)$ (Note 3)
XCEZ5V6	±30	±30	155	12.0
XCEZ6V2	±30	±30	175	11.0
XCEZ6V8	±30	±30	180	10.0
XCEZ7V5	±30	±30	190	9.5
XCEZ8V2	±30	±30	200	8.5
XCEZ9V1	±30	±30	200	8.0
XCEZ10V	±30	±30	200	7.5
XCEZ11V	±30	±30	200	7.25
XCEZ12V	±30	±30	200	7.0
XCEZ13V	±30	±30	200	6.5
XCEZ15V	±30	±30	200	5.6
XCEZ16V	±30	±30	200	5.5
XCEZ18V	±30	±30	200	5.1
XCEZ20V	±30	±30	200	5.0
XCEZ22V	±30	±30	200	4.75
XCEZ24V	±30	±30	200	4.5
XCEZ27V	±20	±30	200	4.1
XCEZ30V	±20	±30	200	4.0
XCEZ33V	±17	±25	200	3.5
XCEZ36V	±12	±20	200	3.0

Note: Using continuously under heavy loads (e.g. the application of high temperature/current/voltage and the significant change in temperature, etc.) may cause this product to decrease in the reliability significantly even if the operating conditions (i.e. operating temperature/current/voltage, etc.) are within the absolute maximum ratings.

Please design the appropriate reliability upon reviewing the Toshiba Semiconductor Reliability Handbook ("Handling Precautions"/"Derating Concept and Methods") and individual reliability data (i.e. reliability test report and estimated failure rate, etc).

Note1: according to IEC61000-4-2(C = 150 pF / R = 330 Ω)

Note2: according to ISO10605(C = 330 pF / R = 2 k Ω)

Note3: according to IEC61000-4-5(tp = 8 / 20 μ s)

6. Electrical Characteristics 1 (Unless otherwise specified, $T_a = 25\text{ }^\circ\text{C}$)

Type No.	Zener Voltage V_Z (V)				Dynamic Impedance Z_Z (Ω)		Reverse Current $I_R(1)$ (μA)		Reverse Current $I_R(2)$ (μA)	
	Min	Typ.	Max	Test Current I_Z (mA)	Max	Test Current I_Z (mA)	Max	Test Voltage V_R (V)	Max	Test Voltage V_R (V)
XCEZ5V6	5.3	5.6	6.0	5	30	5	1.0	2.5	1.0	3.5
XCEZ6V2	5.8	6.2	6.6	5	30	5	1.0	3.0	2.5	5.0
XCEZ6V8	6.4	6.8	7.2	5	30	5	0.5	3.5	1.5	5.5
XCEZ7V5	7.0	7.5	7.9	5	30	5	0.1	4.0	0.1	6.0
XCEZ8V2	7.7	8.2	8.7	5	30	5	0.1	5.0	0.1	7.0
XCEZ9V1	8.5	9.1	9.6	5	30	5	0.1	6.0	0.1	7.5
XCEZ10V	9.4	10.0	10.6	5	30	5	0.1	7.0	0.1	8.0
XCEZ11V	10.4	11.0	11.6	5	30	5	0.1	8.0	0.1	9.0
XCEZ12V	11.4	12.0	12.6	5	30	5	0.1	9.0	0.1	10.0
XCEZ13V	12.4	13.0	14.1	5	30	5	0.1	10.0	0.1	11.0
XCEZ15V	13.8	15.0	15.6	5	30	5	0.1	11.0	0.1	12.0
XCEZ16V	15.3	16.0	17.1	5	35	5	0.1	12.0	0.1	14.0
XCEZ18V	16.8	18.0	19.1	5	45	5	0.1	13.0	0.1	16.0
XCEZ20V	18.8	20.0	21.2	5	70	5	0.1	15.0	0.1	17.6
XCEZ22V	20.8	22.0	23.3	5	70	5	0.1	17.0	0.1	18.0
XCEZ24V	22.8	24.0	25.6	5	70	5	0.1	19.0	0.1	19.0
XCEZ27V	25.1	27.0	28.9	2	70	2	0.1	21.0	0.1	23.0
XCEZ30V	28.0	30.0	32.0	2	100	2	0.1	23.0	0.1	27.0
XCEZ33V	31.0	33.0	35.0	2	100	2	0.1	25.0	0.1	30.0
XCEZ36V	34.0	36.0	38.0	2	100	2	0.1	27.0	0.1	32.5

7. Electrical Characteristics 2 (Unless otherwise specified, Ta = 25 °C)

Type No.	Dynamic Resistance R _{DYN} (Ω) (Note 1)	Clamp Voltage V _C (V) (Note 1) (Note 2)	Total Capacitance C _t (pF) (Note 3)
Type No.	Typ.	Typ.	Typ.
XCEZ5V6	0.16	9.0	125
XCEZ6V2	0.21	10.0	105
XCEZ6V8	0.27	13.0	88
XCEZ7V5	0.32	14.0	78
XCEZ8V2	0.37	16.5	67
XCEZ9V1	0.44	17.0	62
XCEZ10V	0.52	19.0	60
XCEZ11V	0.60	24.0	48
XCEZ12V	0.70	26.0	44
XCEZ13V	0.80	27.0	42
XCEZ15V	0.60	24.0	36
XCEZ16V	0.50	27.0	35
XCEZ18V	0.40	28.5	31
XCEZ20V	0.35	30.5	29
XCEZ22V	0.40	32.0	27
XCEZ24V	0.60	36.5	26
XCEZ27V	0.90	45.0	23
XCEZ30V	1.25	47.5	21
XCEZ33V	1.80	57.0	19
XCEZ36V	2.60	63.0	18

Note1: TLP parameters: Z₀ = 50 Ω, t_p = 100 ns, t_r = 300 ps, averaging window: t₁ = 30 ns to t₂ = 60 ns, extraction of dynamic resistance using least squares fit of TLP characteristics between I_{TLP1} = 16 A and I_{TLP2} = 30 A.

Note2: I_{TLP} = 16 A

Note3: V_R = 0 V, f = 1 MHz

8. Marking List

Type No.	Marking	Type No.	Marking	Type No.	Marking
XCEZ5V6	NL	XCEZ11V	P3	XCEZ22V	PA
XCEZ6V2	NM	XCEZ12V	P4	XCEZ24V	PB
XCEZ6V8	NN	XCEZ13V	P5	XCEZ27V	PC
XCEZ7V5	NP	XCEZ15V	P6	XCEZ30V	PD
XCEZ8V2	NQ	XCEZ16V	P7	XCEZ33V	PE
XCEZ9V1	NR	XCEZ18V	P8	XCEZ36V	PF
XCEZ10V	P2	XCEZ20V	P9	—	—

9. Marking

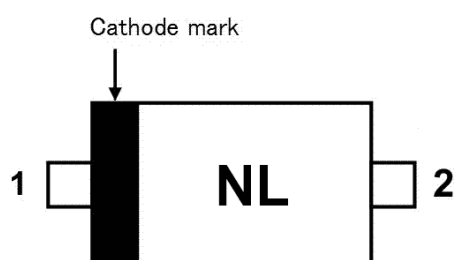

Fig. 9.1 XCEZ5V6

10. Land Pattern Dimensions (for reference only)

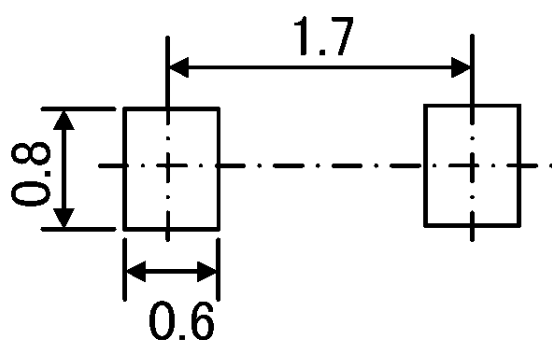

Fig. 10.1 Land Pattern Dimensions
(for reference only) (Unit: mm)

11. Characteristics Curves

11.1. XCEZ series Characteristics Curves(Note)

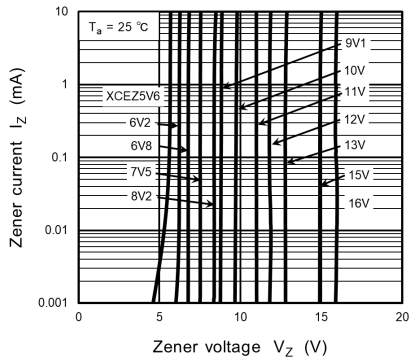

Fig. 11.1.1 $I_Z - V_Z(1)$

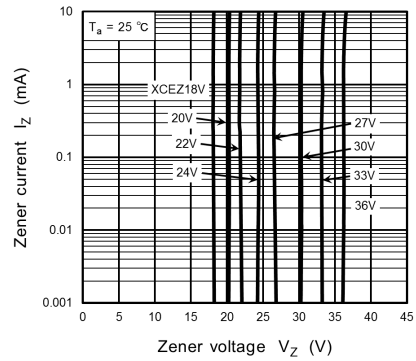

Fig. 11.1.2 $I_Z - V_Z(2)$

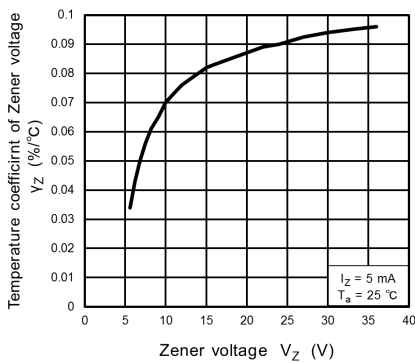

Fig. 11.1.3 $\gamma_Z - V_Z$

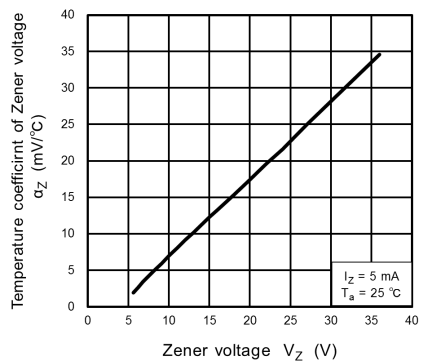

Fig. 11.1.4 $\alpha_Z - V_Z$

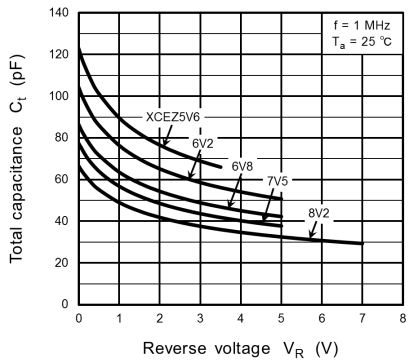

Fig. 11.1.5 $C_t - V_R (1)$

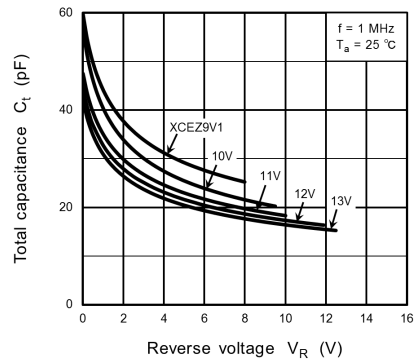

Fig. 11.1.6 $C_t - V_R (2)$

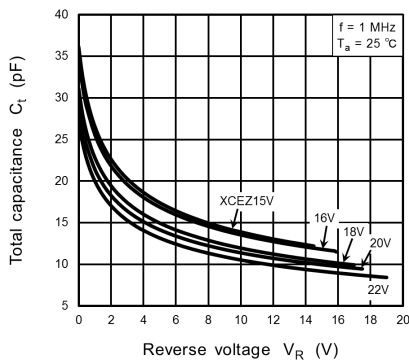

Fig. 11.1.7 $C_t - V_R (3)$

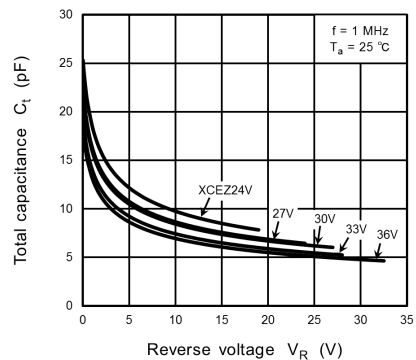

Fig. 11.1.8 $C_t - V_R (4)$

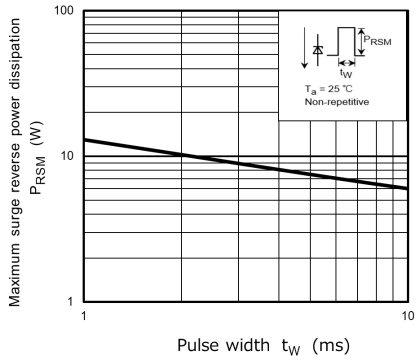

Fig. 11.1.9 $P_{RSM} - t_w$

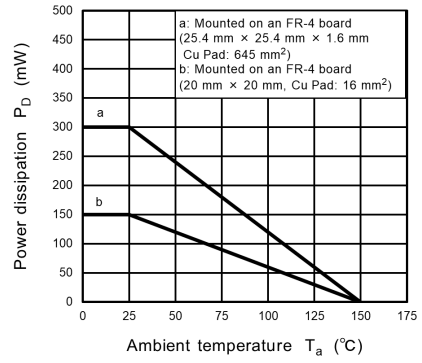

Fig. 11.1.10 $P_D - T_a$

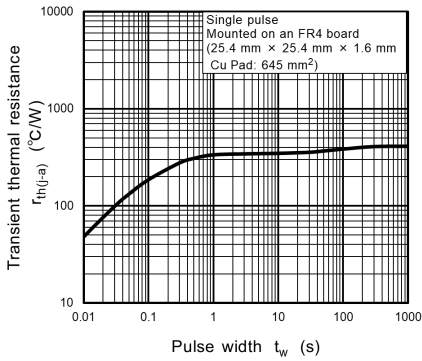

Fig. 11.1.11 $r_{th(j-a)} - t_w$

Note: The above characteristics curves are presented for reference only and not guaranteed by production test, unless otherwise noted.

11.2. XCEZ5V6 Characteristics Curves(Note)

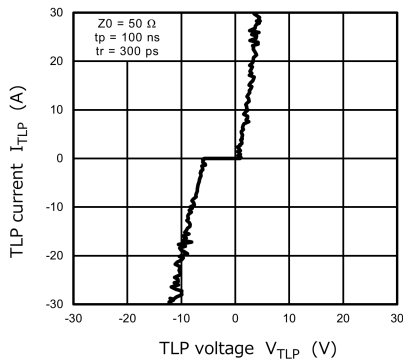

Fig. 11.2.1 $I_{TLP} - V_{TLP}$

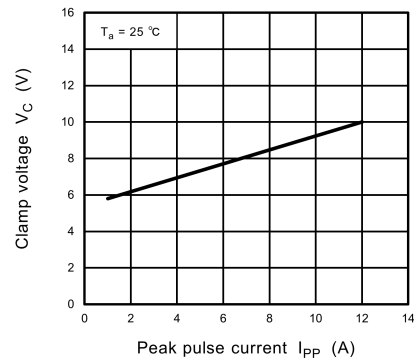

Fig. 11.2.2 $V_C - I_{PP}$

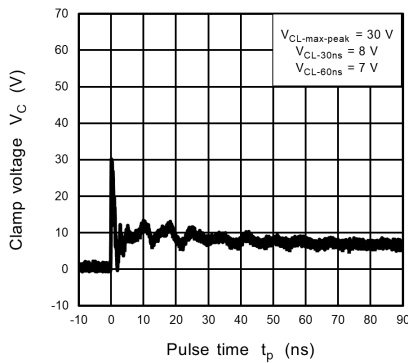

Fig. 11.2.3 IEC61000-4-2 Clamp Waveform +8 kV

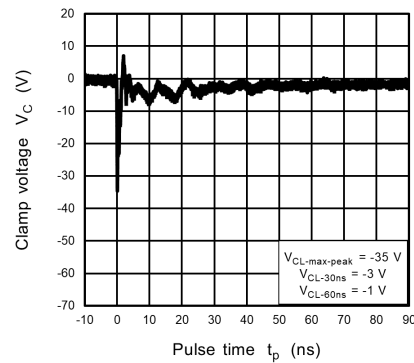

Fig. 11.2.4 IEC61000-4-2 Clamp Waveform -8 kV

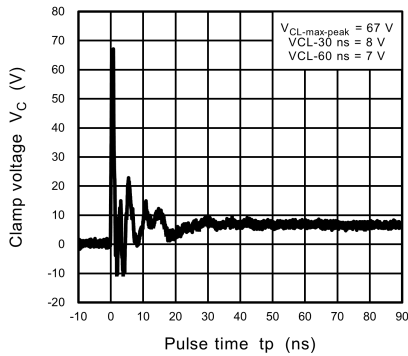

Fig. 11.2.5 ISO10605 Clamp Waveform +8 kV

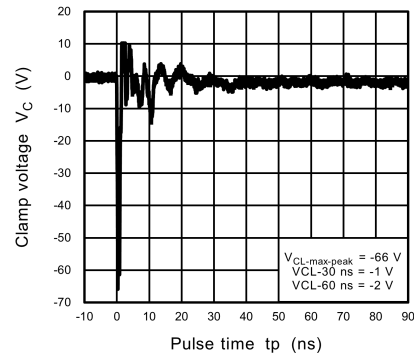

Fig. 11.2.6 ISO10605 Clamp Waveform -8 kV

Note: The above characteristics curves are presented for reference only and not guaranteed by production test, unless otherwise noted.

Refer to Fig.11.22.1, Fig.11.22.2, Fig.11.22.3 for peak pulse current(V_C-I_{PP}) and clamp waveform measurement circuit.

11.3. XCEZ6V2 Characteristics Curves(Note)

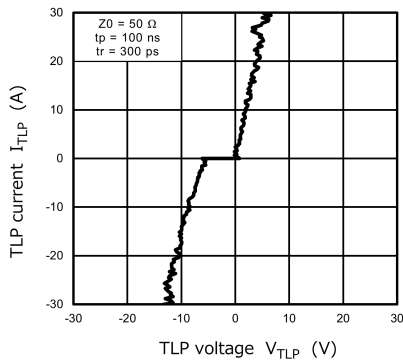

Fig. 11.3.1 $I_{TLP} - V_{TLP}$

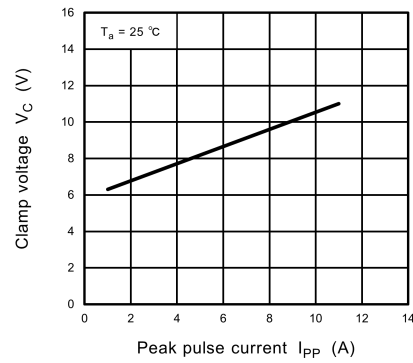
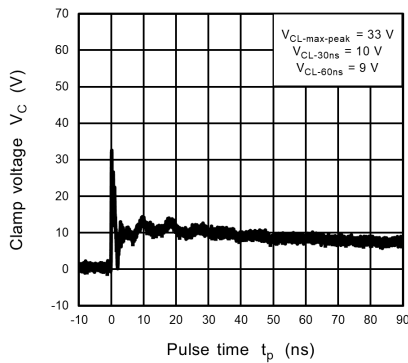
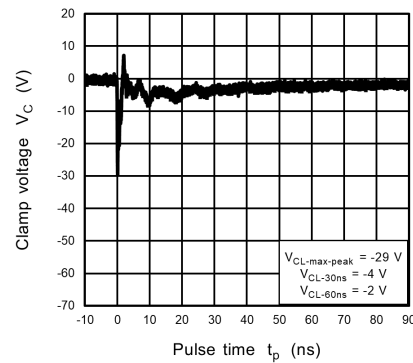

Fig. 11.3.2 $V_C - I_{PP}$



**Fig. 11.3.3 IEC61000-4-2
Clamp Waveform +8 kV**



**Fig. 11.3.4 IEC61000-4-2
Clamp Waveform -8 kV**

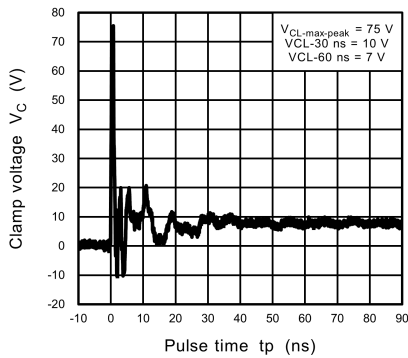

**Fig. 11.3.5 ISO10605
Clamp Waveform +8 kV**

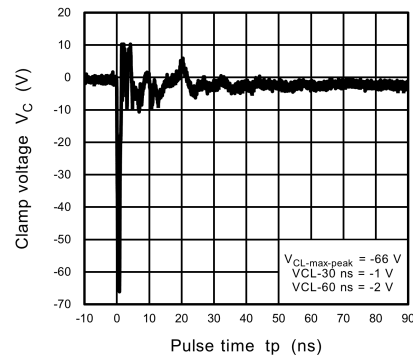

**Fig. 11.3.6 ISO10605
Clamp Waveform -8 kV**

Note: The above characteristics curves are presented for reference only and not guaranteed by production test, unless otherwise noted.

Refer to Fig.11.22.1, Fig.11.22.2, Fig.11.22.3 for peak pulse current(V_C-I_{PP}) and clamp waveform measurement circuit.

11.4. XCEZ6V8 Characteristics Curves(Note)

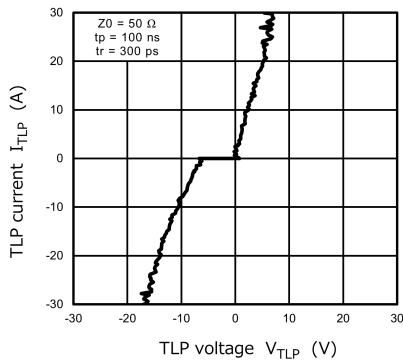

Fig. 11.4.1 $I_{TLP} - V_{TLP}$

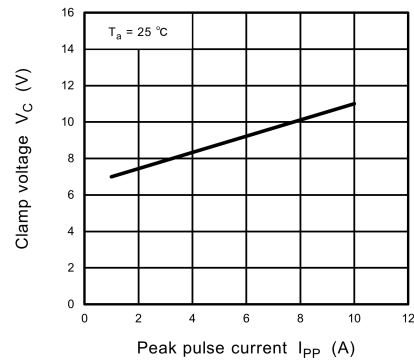
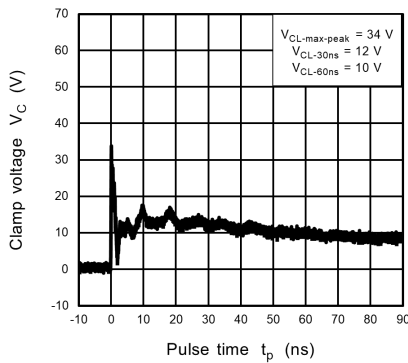
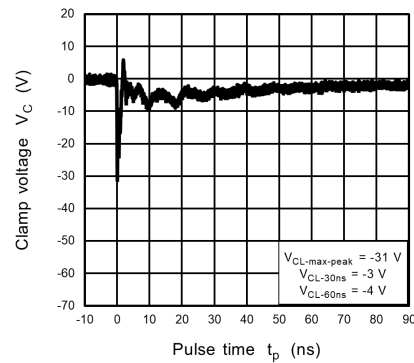

Fig. 11.4.2 $V_C - I_{PP}$



**Fig. 11.4.3 IEC61000-4-2
Clamp Waveform +8 kV**



**Fig. 11.4.4 IEC61000-4-2
Clamp Waveform -8 kV**

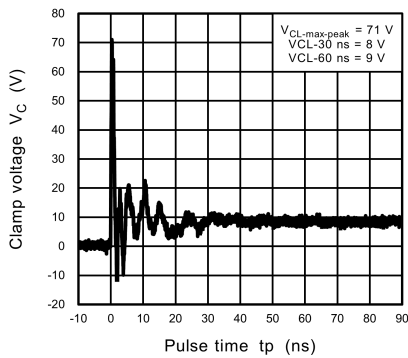

**Fig. 11.4.5 ISO10605
Clamp Waveform +8 kV**

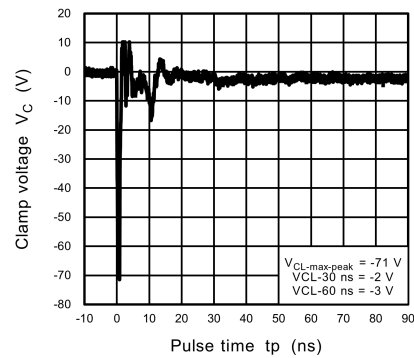

**Fig. 11.4.6 ISO10605
Clamp Waveform -8 kV**

Note: The above characteristics curves are presented for reference only and not guaranteed by production test, unless otherwise noted.

Refer to Fig.11.22.1, Fig.11.22.2, Fig.11.22.3 for peak pulse current(V_C-I_{PP}) and clamp waveform measurement circuit.

11.5. XCEZ7V5 Characteristics Curves(Note)

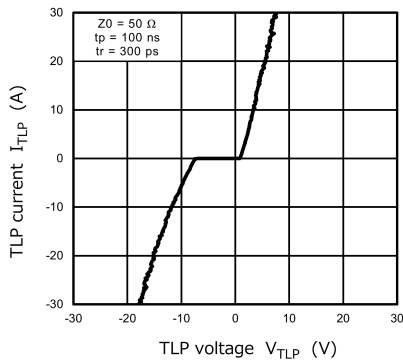

Fig. 11.5.1 $I_{TLP} - V_{TLP}$

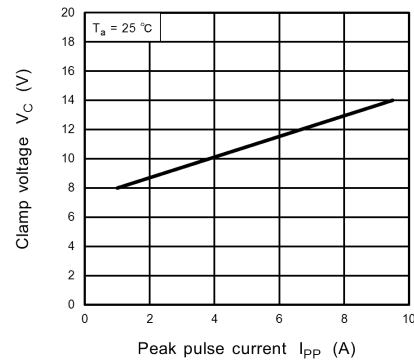
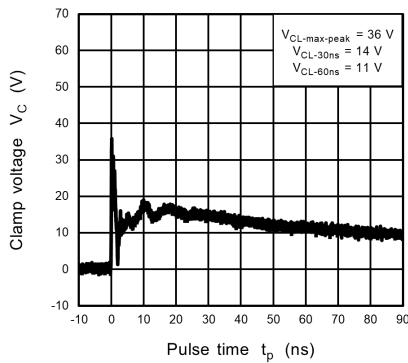
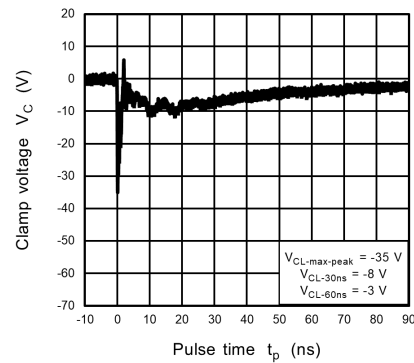

Fig. 11.5.2 $V_C - I_{PP}$



**Fig. 11.5.3 IEC61000-4-2
Clamp Waveform +8 kV**



**Fig. 11.5.4 IEC61000-4-2
Clamp Waveform -8 kV**

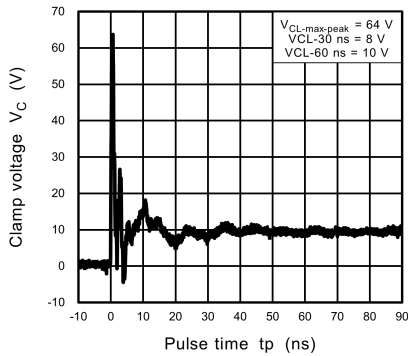

**Fig. 11.5.5 ISO10605
Clamp Waveform +8 kV**

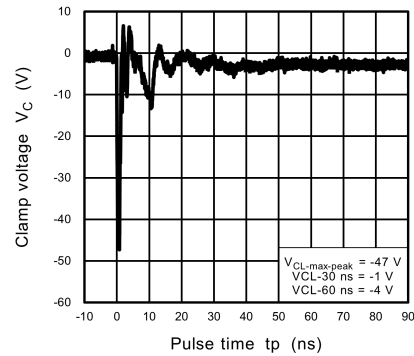

**Fig. 11.5.6 ISO10605
Clamp Waveform -8 kV**

Note: The above characteristics curves are presented for reference only and not guaranteed by production test, unless otherwise noted.

Refer to Fig.11.22.1, Fig.11.22.2, Fig.11.22.3 for peak pulse current(V_C-I_{PP}) and clamp waveform measurement circuit.

11.6. XCEZ8V2 Characteristics Curves(Note)

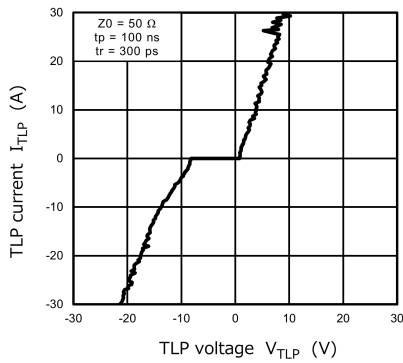

Fig. 11.6.1 $I_{TLP} - V_{TLP}$

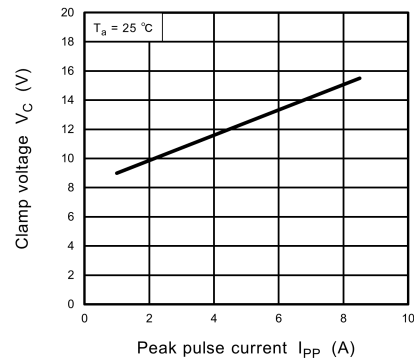
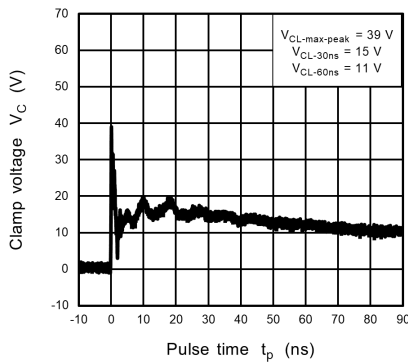
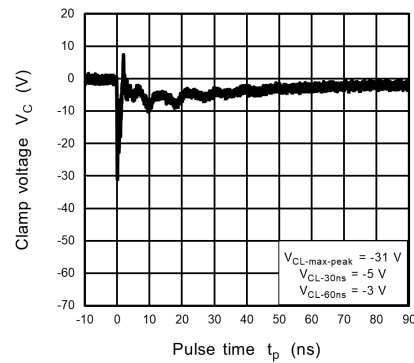

Fig. 11.6.2 $V_C - I_{PP}$



**Fig. 11.6.3 IEC61000-4-2
Clamp Waveform +8 kV**



**Fig. 11.6.4 IEC61000-4-2
Clamp Waveform -8 kV**

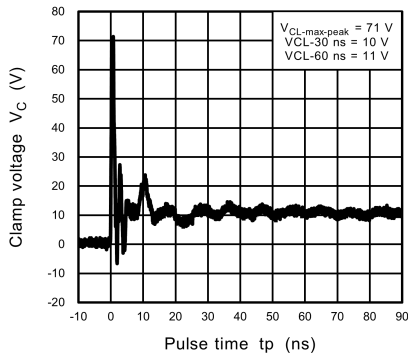

**Fig. 11.6.5 ISO10605
Clamp Waveform +8 kV**

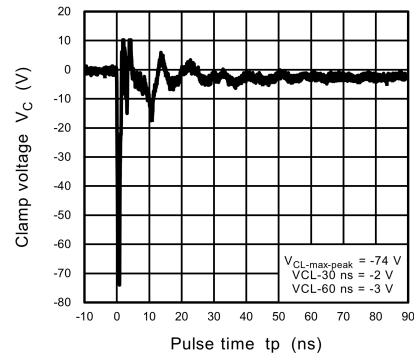

**Fig. 11.6.6 ISO10605
Clamp Waveform -8 kV**

Note: The above characteristics curves are presented for reference only and not guaranteed by production test, unless otherwise noted.

Refer to Fig.11.22.1, Fig.11.22.2, Fig.11.22.3 for peak pulse current(V_C-I_{PP}) and clamp waveform measurement circuit.

11.7. XCEZ9V1 Characteristics Curves(Note)

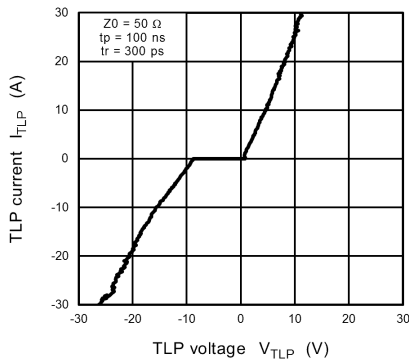

Fig. 11.7.1 $I_{TLP} - V_{TLP}$

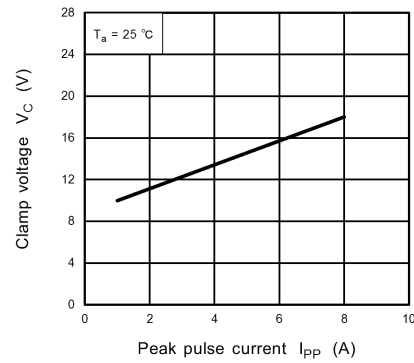
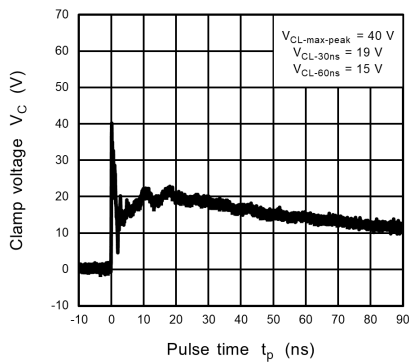
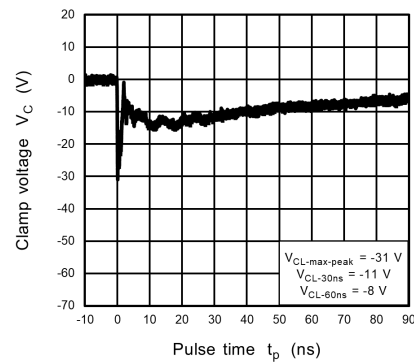

Fig. 11.7.2 $V_C - I_{PP}$



**Fig. 11.7.3 IEC61000-4-2
Clamp Waveform +8 kV**



**Fig. 11.7.4 IEC61000-4-2
Clamp Waveform -8 kV**

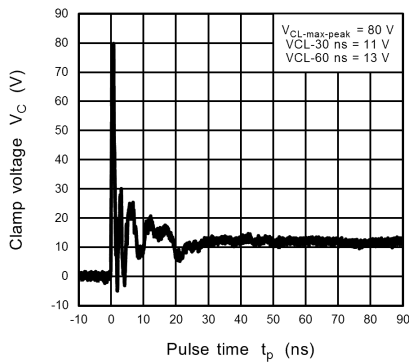

**Fig. 11.7.5 ISO10605
Clamp Waveform +8 kV**

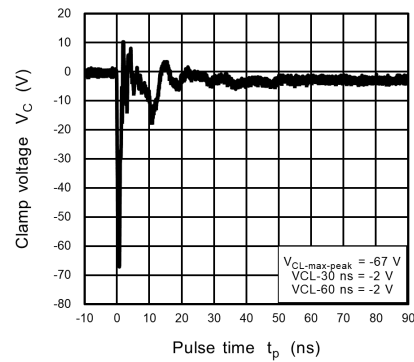

**Fig. 11.7.6 ISO10605
Clamp Waveform -8 kV**

Note: The above characteristics curves are presented for reference only and not guaranteed by production test, unless otherwise noted.

Refer to Fig.11.22.1, Fig.11.22.2, Fig.11.22.3 for peak pulse current(V_C-I_{PP}) and clamp waveform measurement circuit.

11.8. XCEZ10V Characteristics Curves(Note)

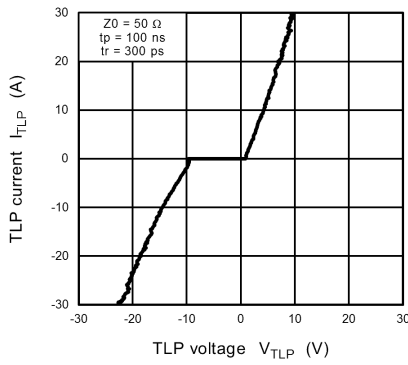

Fig. 11.8.1 $I_{TLP} - V_{TLP}$

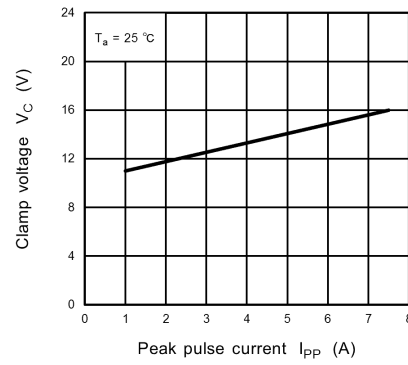
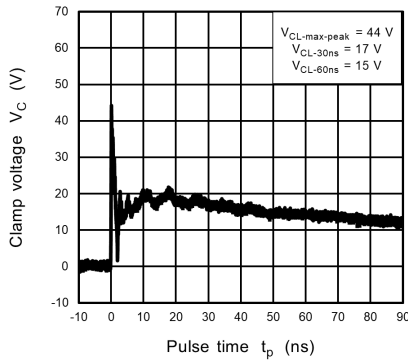
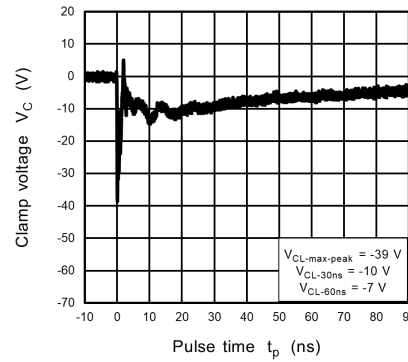

Fig. 11.8.2 $V_C - I_{PP}$



**Fig. 11.8.3 IEC61000-4-2
Clamp Waveform +8 kV**



**Fig. 11.8.4 IEC61000-4-2
Clamp Waveform -8 kV**

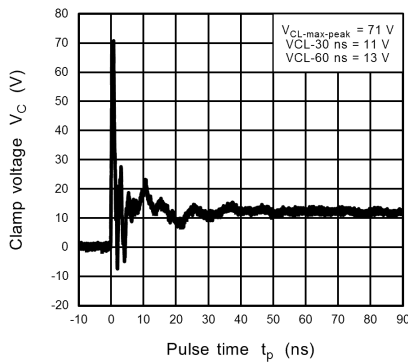

**Fig. 11.8.5 ISO10605
Clamp Waveform +8 kV**

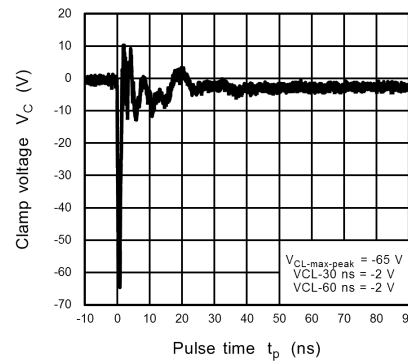

**Fig. 11.8.6 ISO10605
Clamp Waveform -8 kV**

Note: The above characteristics curves are presented for reference only and not guaranteed by production test, unless otherwise noted.

Refer to Fig.11.22.1, Fig.11.22.2, Fig.11.22.3 for peak pulse current(V_C-I_{PP}) and clamp waveform measurement circuit.

11.9. XCEZ11V Characteristics Curves(Note)

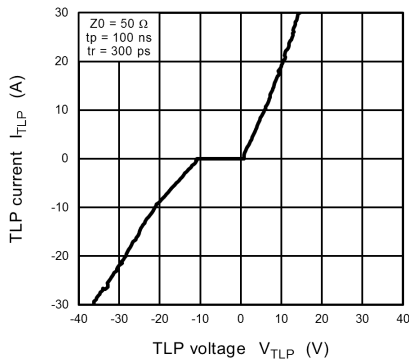

Fig. 11.9.1 $I_{TLP} - V_{TLP}$

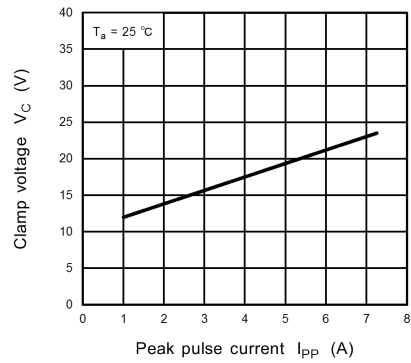
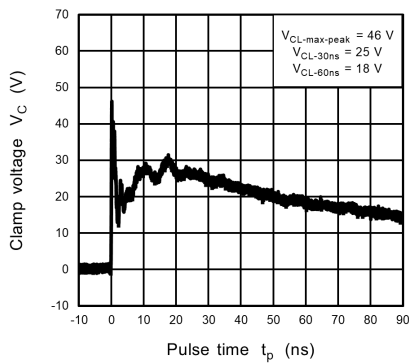
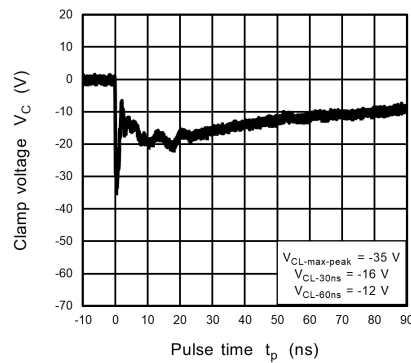

Fig. 11.9.2 $V_C - I_{PP}$



**Fig. 11.9.3 IEC61000-4-2
Clamp Waveform +8 kV**



**Fig. 11.9.4 IEC61000-4-2
Clamp Waveform -8 kV**

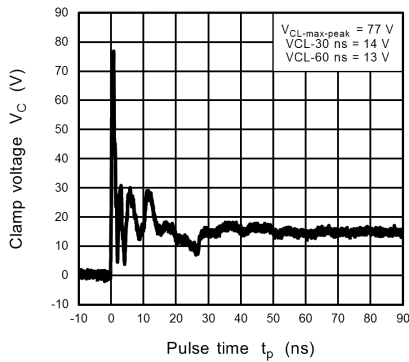

**Fig. 11.9.5 ISO10605
Clamp Waveform +8 kV**

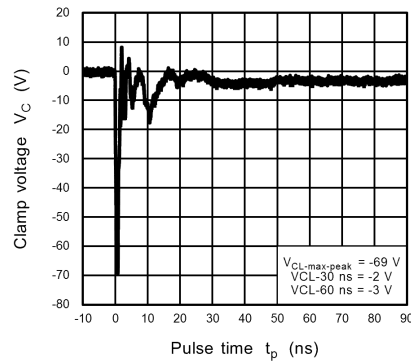

**Fig. 11.9.6 ISO10605
Clamp Waveform -8 kV**

Note: The above characteristics curves are presented for reference only and not guaranteed by production test, unless otherwise noted.

Refer to Fig.11.22.1, Fig.11.22.2, Fig.11.22.3 for peak pulse current(V_C-I_{PP}) and clamp waveform measurement circuit.

11.10. XCEZ12V Characteristics Curves(Note)

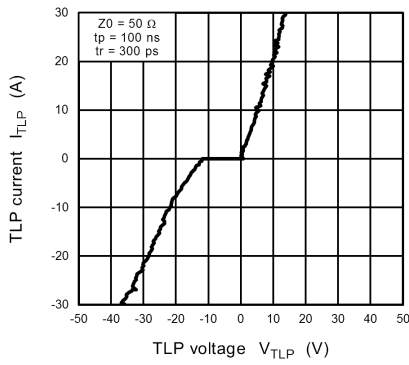

Fig. 11.10.1 $I_{TLP} - V_{TLP}$

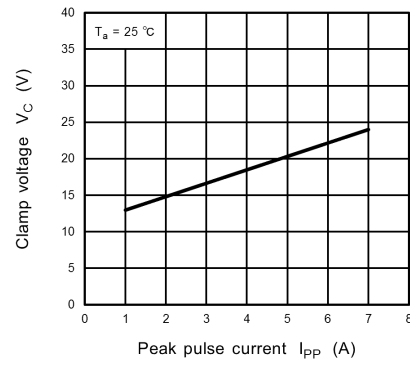
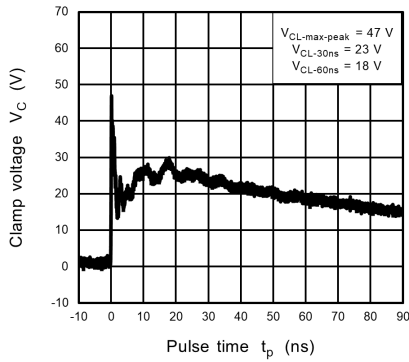
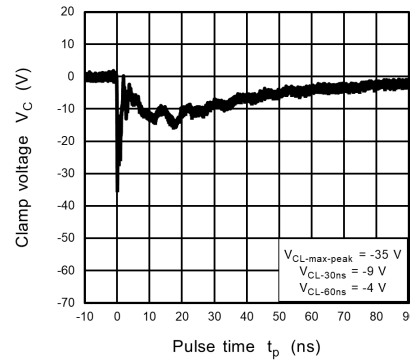

Fig. 11.10.2 $V_C - I_{PP}$



**Fig. 11.10.3 IEC61000-4-2
Clamp Waveform +8 kV**



**Fig. 11.10.4 IEC61000-4-2
Clamp Waveform -8 kV**

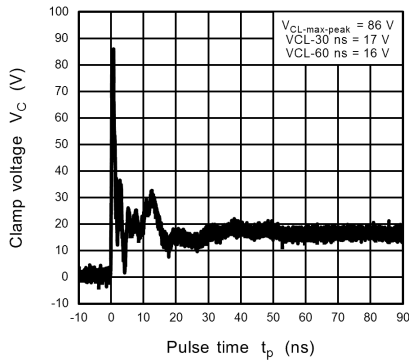

**Fig. 11.10.5 ISO10605
Clamp Waveform +8 kV**

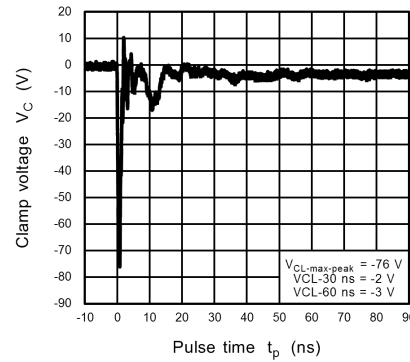

**Fig. 11.10.6 ISO10605
Clamp Waveform -8 kV**

Note: The above characteristics curves are presented for reference only and not guaranteed by production test, unless otherwise noted.

Refer to Fig.11.22.1, Fig.11.22.2, Fig.11.22.3 for peak pulse current(V_C-I_{PP}) and clamp waveform measurement circuit.

11.11. XCEZ13V Characteristics Curves(Note)

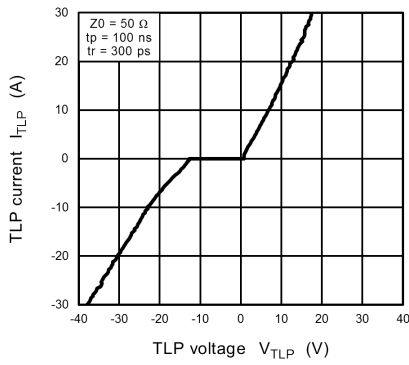

Fig. 11.11.1 $I_{TLP} - V_{TLP}$

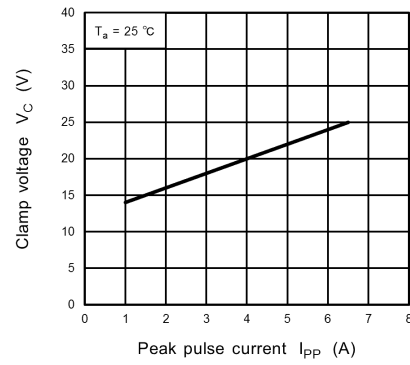
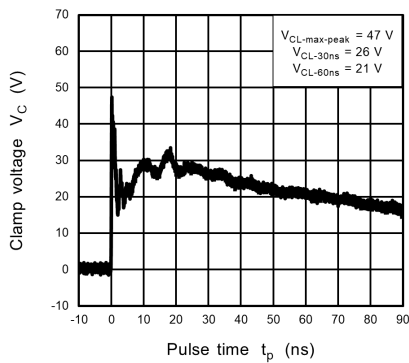
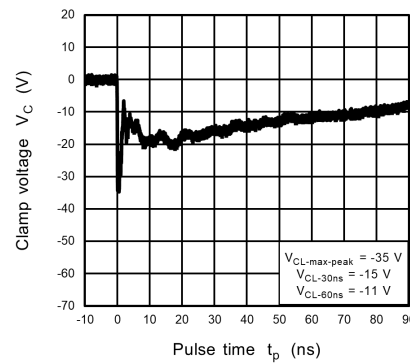

Fig. 11.11.2 $V_C - I_{PP}$



**Fig. 11.11.3 IEC61000-4-2
Clamp Waveform +8 kV**



**Fig. 11.11.4 IEC61000-4-2
Clamp Waveform -8 kV**

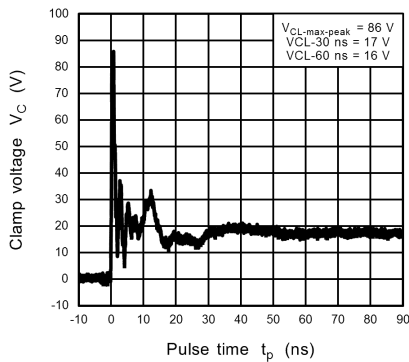

**Fig. 11.11.5 ISO10605
Clamp Waveform +8 kV**

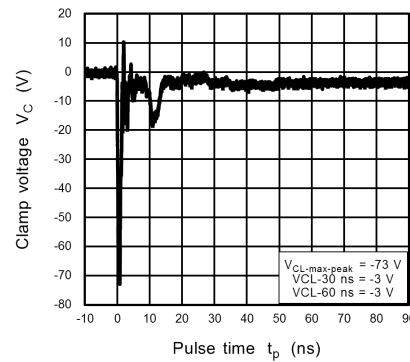

**Fig. 11.11.6 ISO10605
Clamp Waveform -8 kV**

Note: The above characteristics curves are presented for reference only and not guaranteed by production test, unless otherwise noted.

Refer to Fig.11.22.1, Fig.11.22.2, Fig.11.22.3 for peak pulse current(V_C-I_{PP}) and clamp waveform measurement circuit.

11.12. XCEZ15V Characteristics Curves(Note)

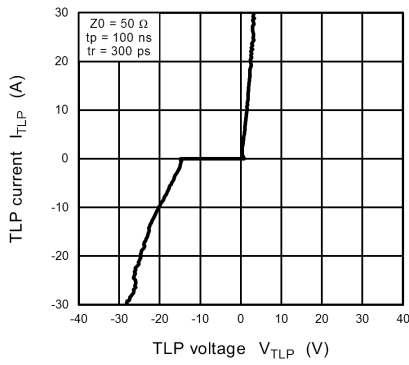

Fig. 11.12.1 $I_{TLP} - V_{TLP}$

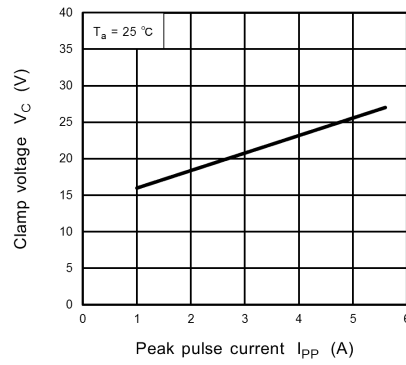
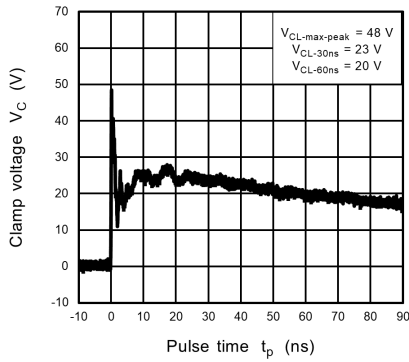
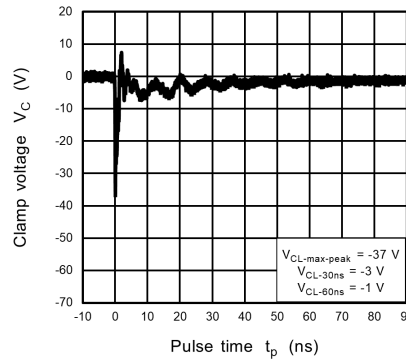

Fig. 11.12.2 $V_C - I_{PP}$



**Fig. 11.12.3 IEC61000-4-2
Clamp Waveform +8 kV**



**Fig. 11.12.4 IEC61000-4-2
Clamp Waveform -8 kV**

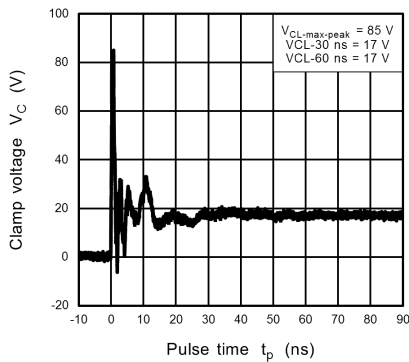

**Fig. 11.12.5 ISO10605
Clamp Waveform +8 kV**

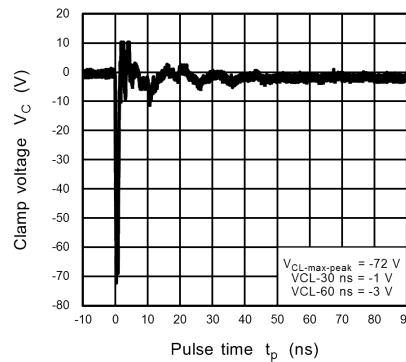

**Fig. 11.12.6 ISO10605
Clamp Waveform -8 kV**

Note: The above characteristics curves are presented for reference only and not guaranteed by production test, unless otherwise noted.

Refer to Fig.11.22.1, Fig.11.22.2, Fig.11.22.3 for peak pulse current(V_C-I_{PP}) and clamp waveform measurement circuit.

11.13. XCEZ16V Characteristics Curves(Note)

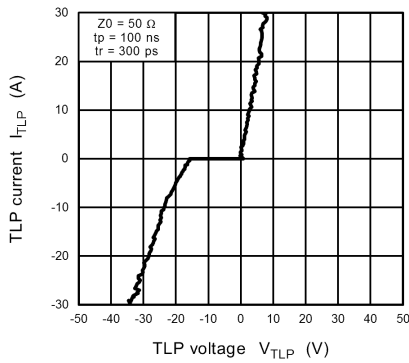

Fig. 11.13.1 $I_{TLP} - V_{TLP}$

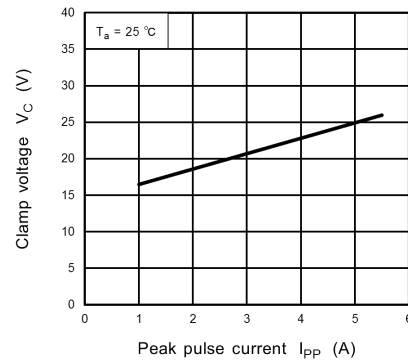

Fig. 11.13.2 $V_C - I_{PP}$

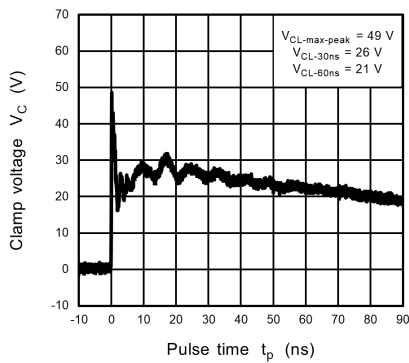

Fig. 11.13.3 IEC61000-4-2
Clamp Waveform +8 kV

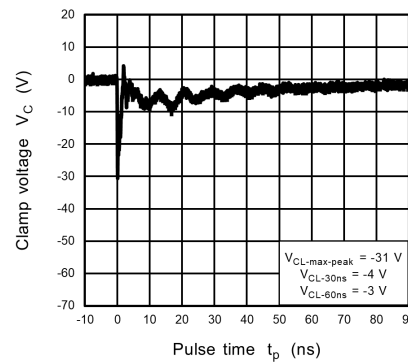

Fig. 11.13.4 IEC61000-4-2
Clamp Waveform -8 kV

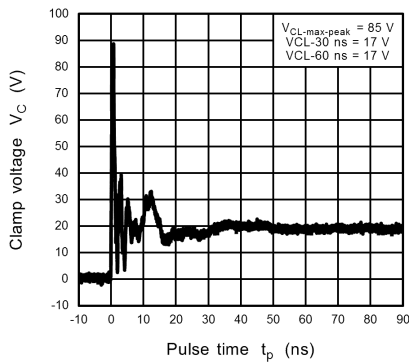

Fig. 11.13.5 ISO10605
Clamp Waveform +8 kV

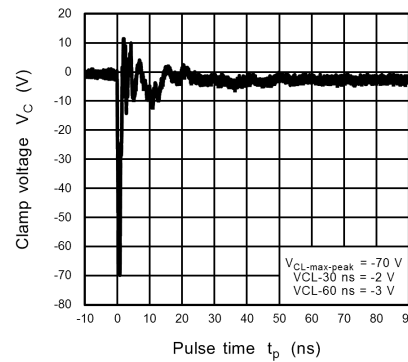

Fig. 11.13.6 ISO10605
Clamp Waveform -8 kV

Note: The above characteristics curves are presented for reference only and not guaranteed by production test, unless otherwise noted.

Refer to Fig.11.22.1, Fig.11.22.2, Fig.11.22.3 for peak pulse current(V_C-I_{PP}) and clamp waveform measurement circuit.

11.14. XCEZ18V Characteristics Curves(Note)

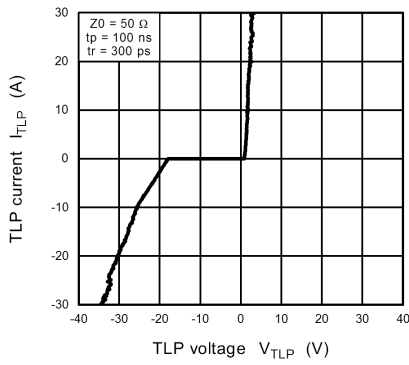

Fig. 11.14.1 $I_{TLP} - V_{TLP}$

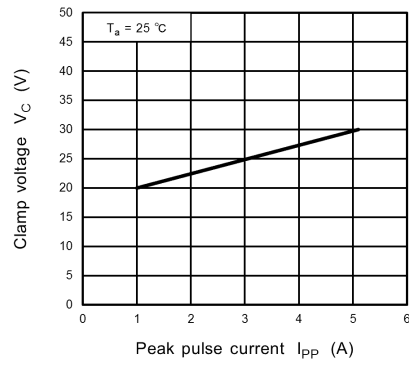

Fig. 11.14.2 $V_C - I_{PP}$

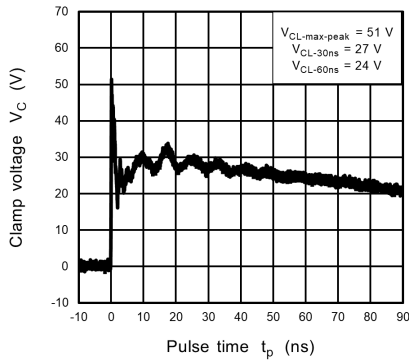

Fig. 11.14.3 IEC61000-4-2
Clamp Waveform +8 kV

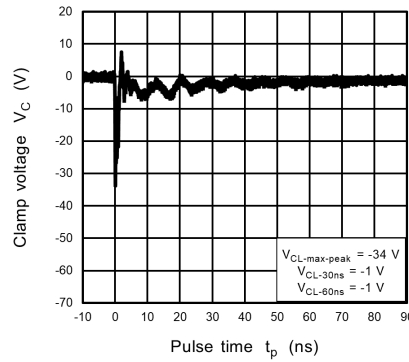

Fig. 11.14.4 IEC61000-4-2
Clamp Waveform -8 kV

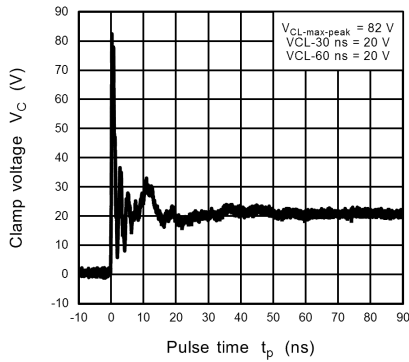

Fig. 11.14.5 ISO10605
Clamp Waveform +8 kV

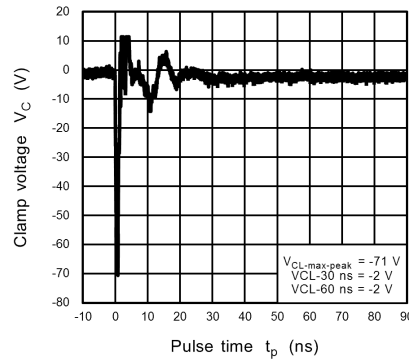

Fig. 11.14.6 ISO10605
Clamp Waveform -8 kV

Note: The above characteristics curves are presented for reference only and not guaranteed by production test, unless otherwise noted.

Refer to Fig.11.22.1, Fig.11.22.2, Fig.11.22.3 for peak pulse current(V_C-I_{PP}) and clamp waveform measurement circuit.

11.15. XCEZ20V Characteristics Curves(Note)

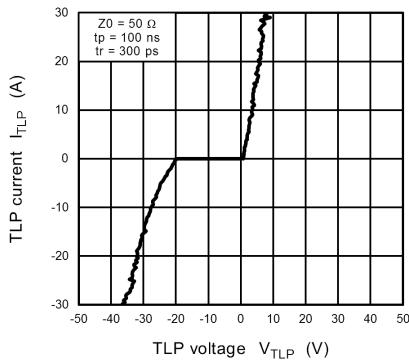

Fig. 11.15.1 $I_{TLP} - V_{TLP}$

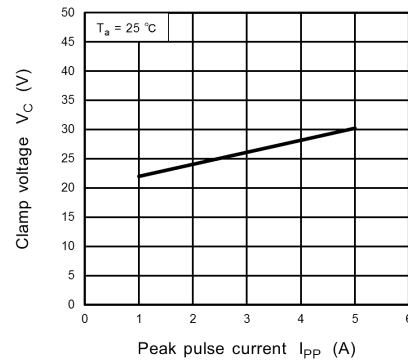

Fig. 11.15.2 $V_C - I_{PP}$

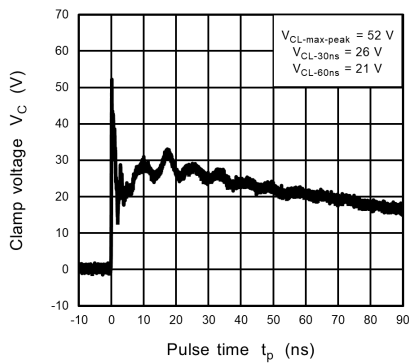

Fig. 11.15.3 IEC61000-4-2
Clamp Waveform +8 kV

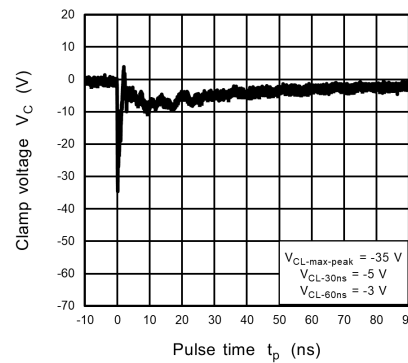

Fig. 11.15.4 IEC61000-4-2
Clamp Waveform -8 kV

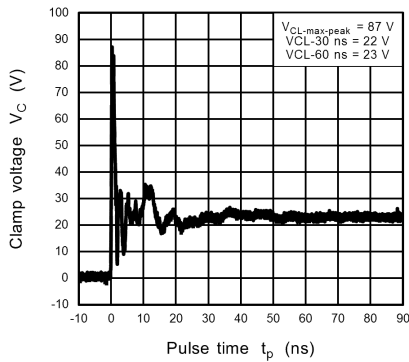

Fig. 11.15.5 ISO10605
Clamp Waveform +8 kV

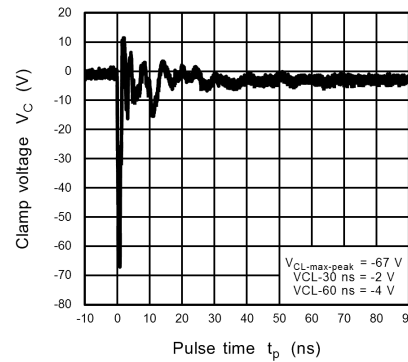

Fig. 11.15.6 ISO10605
Clamp Waveform -8 kV

Note: The above characteristics curves are presented for reference only and not guaranteed by production test, unless otherwise noted.

Refer to Fig.11.22.1, Fig.11.22.2, Fig.11.22.3 for peak pulse current(V_C-I_{PP}) and clamp waveform measurement circuit.

11.16. XCEZ22V Characteristics Curves(Note)

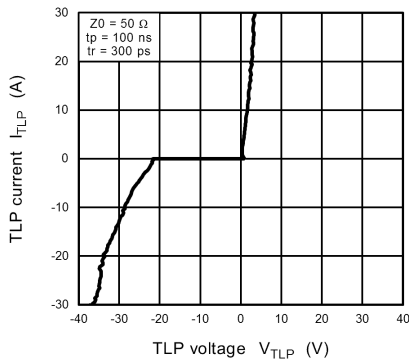

Fig. 11.16.1 $I_{TLP} - V_{TLP}$

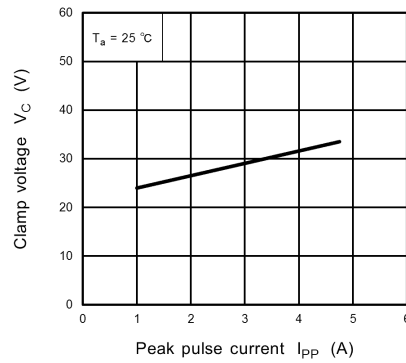
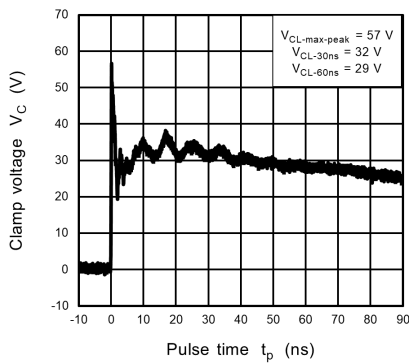
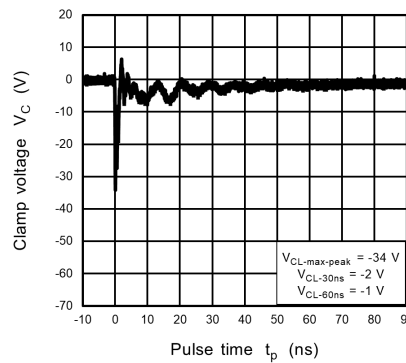

Fig. 11.16.2 $V_C - I_{PP}$



**Fig. 11.16.3 IEC61000-4-2
Clamp Waveform +8 kV**



**Fig. 11.16.4 IEC61000-4-2
Clamp Waveform -8 kV**

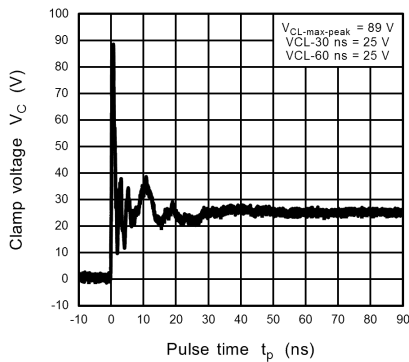

**Fig. 11.16.5 ISO10605
Clamp Waveform +8 kV**

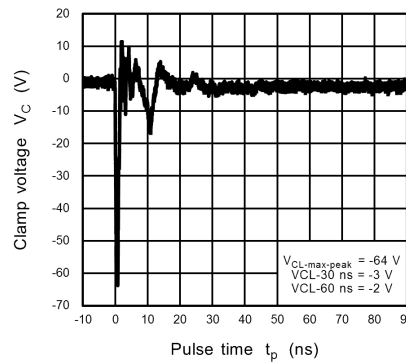

**Fig. 11.16.6 ISO10605
Clamp Waveform -8 kV**

Note: The above characteristics curves are presented for reference only and not guaranteed by production test, unless otherwise noted.

Refer to Fig.11.22.1, Fig.11.22.2, Fig.11.22.3 for peak pulse current(V_C-I_{PP}) and clamp waveform measurement circuit.

11.17. XCEZ24V Characteristics Curves(Note)

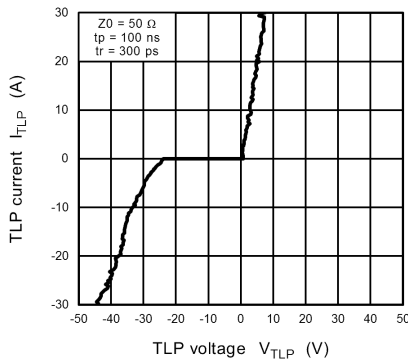

Fig. 11.17.1 $I_{TLP} - V_{TLP}$

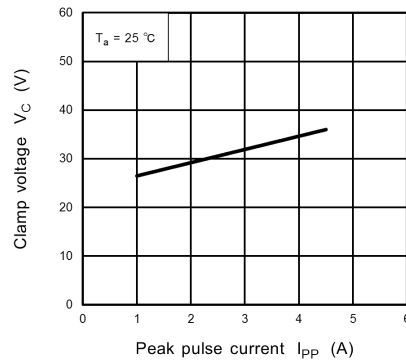

Fig. 11.17.2 $V_C - I_{PP}$

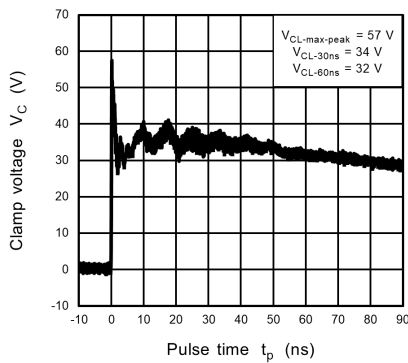

Fig. 11.17.3 IEC61000-4-2
Clamp Waveform +8 kV

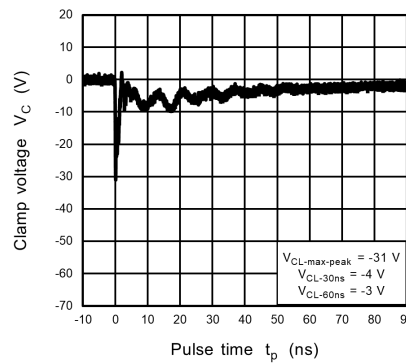

Fig. 11.17.4 IEC61000-4-2
Clamp Waveform -8 kV

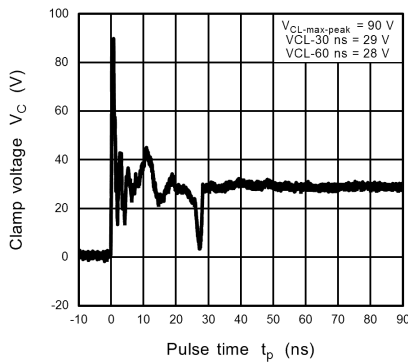

Fig. 11.17.5 ISO10605
Clamp Waveform +8 kV

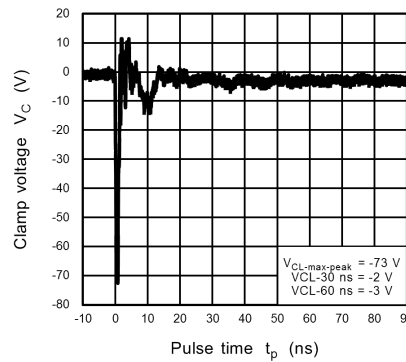

Fig. 11.17.6 ISO10605
Clamp Waveform -8 kV

Note: The above characteristics curves are presented for reference only and not guaranteed by production test, unless otherwise noted.

Refer to Fig.11.22.1, Fig.11.22.2, Fig.11.22.3 for peak pulse current(V_C-I_{PP}) and clamp waveform measurement circuit.

11.18. XCEZ27V Characteristics Curves(Note)

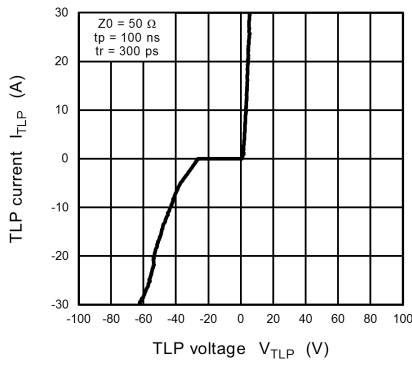

Fig. 11.18.1 $I_{TLP} - V_{TLP}$

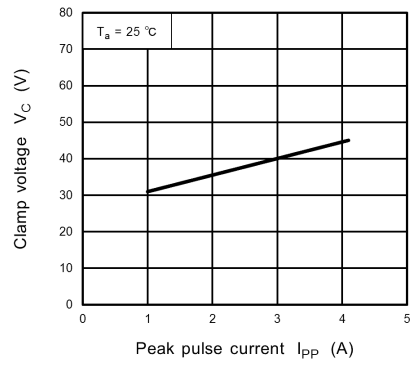

Fig. 11.18.2 $V_C - I_{PP}$

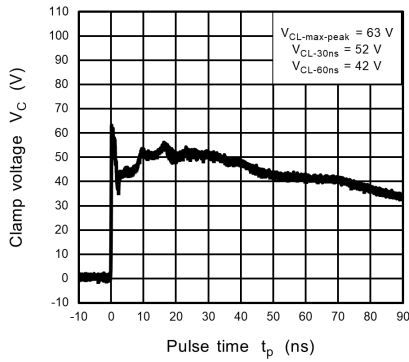

Fig. 11.18.3 IEC61000-4-2
Clamp Waveform +8 kV

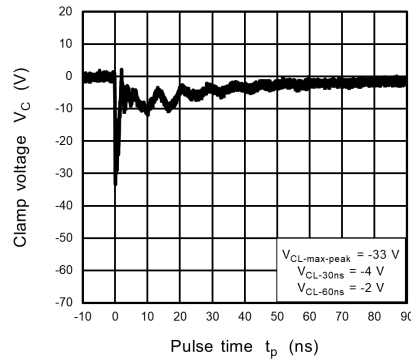

Fig. 11.18.4 IEC61000-4-2
Clamp Waveform -8 kV

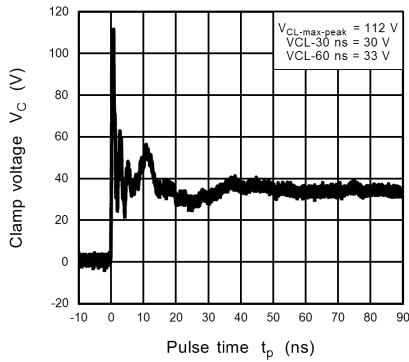

Fig. 11.18.5 ISO10605
Clamp Waveform +8 kV

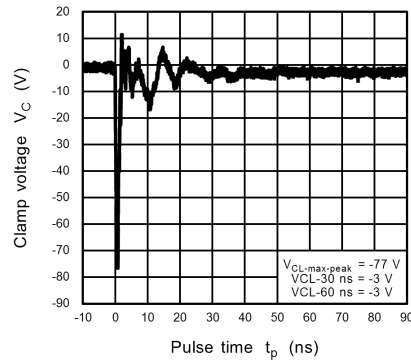

Fig. 11.18.6 ISO10605
Clamp Waveform -8 kV

Note: The above characteristics curves are presented for reference only and not guaranteed by production test, unless otherwise noted.

Refer to Fig.11.22.1, Fig.11.22.2, Fig.11.22.3 for peak pulse current(V_C-I_{PP}) and clamp waveform measurement circuit.

11.19. XCEZ30V Characteristics Curves(Note)

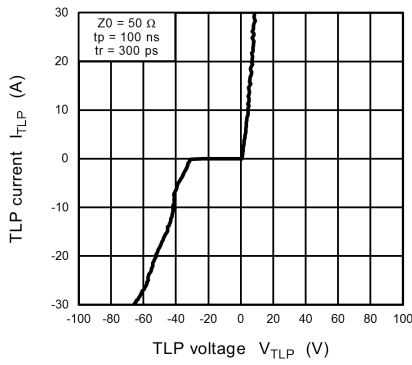

Fig. 11.19.1 $I_{TLP} - V_{TLP}$

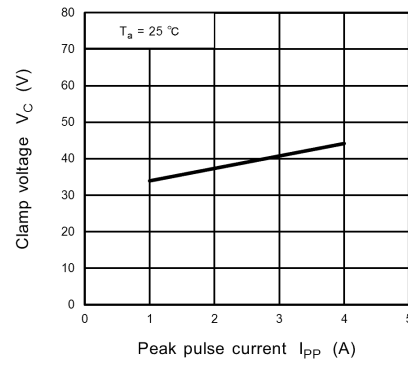

Fig. 11.19.2 $V_C - I_{PP}$

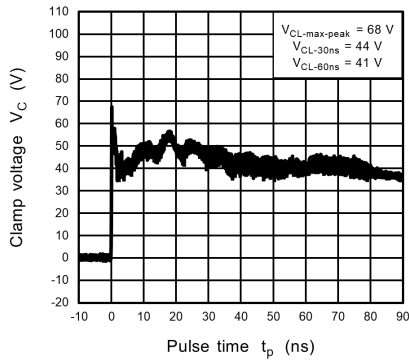

Fig. 11.19.3 IEC61000-4-2
Clamp Waveform +8 kV

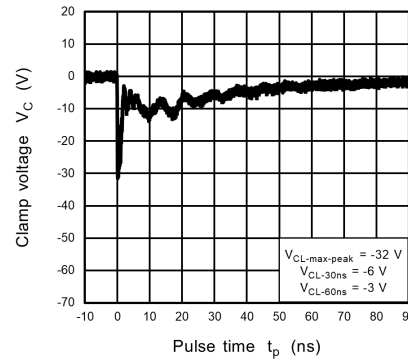

Fig. 11.19.4 IEC61000-4-2
Clamp Waveform -8 kV

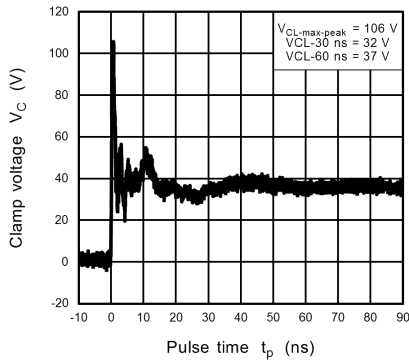

Fig. 11.19.5 ISO10605
Clamp Waveform +8 kV

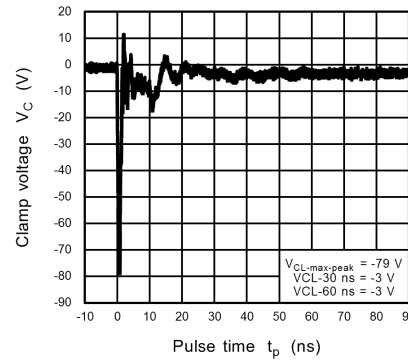

Fig. 11.19.6 ISO10605
Clamp Waveform -8 kV

Note: The above characteristics curves are presented for reference only and not guaranteed by production test, unless otherwise noted.

Refer to Fig.11.22.1, Fig.11.22.2, Fig.11.22.3 for peak pulse current(V_C-I_{PP}) and clamp waveform measurement circuit.

11.20. XCEZ33V Characteristics Curves(Note)

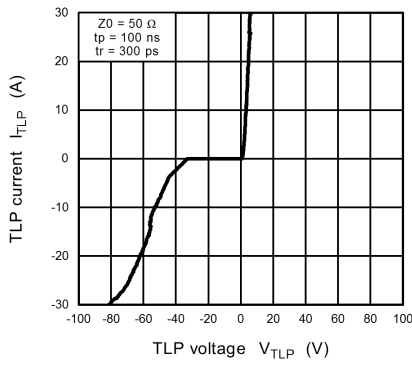

Fig. 11.20.1 $I_{TLP} - V_{TLP}$

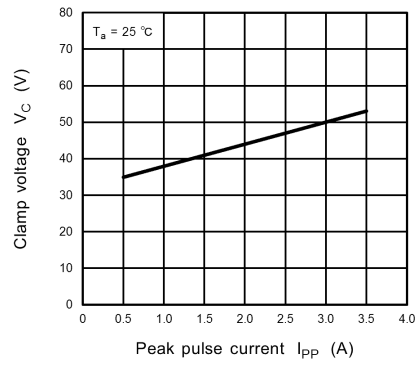
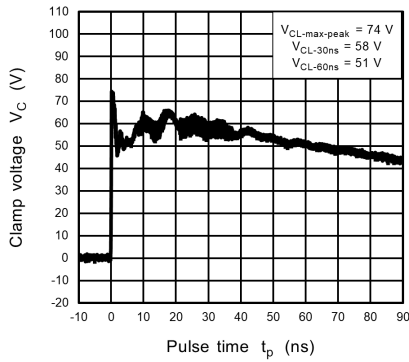
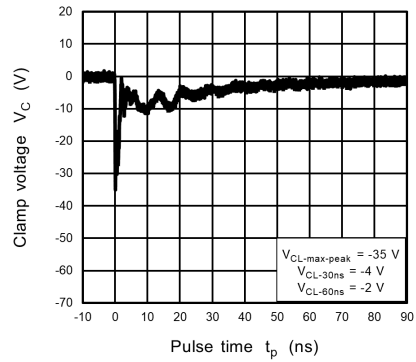

Fig. 11.20.2 $V_C - I_{PP}$



**Fig. 11.20.3 IEC61000-4-2
Clamp Waveform +8 kV**



**Fig. 11.20.4 IEC61000-4-2
Clamp Waveform -8 kV**

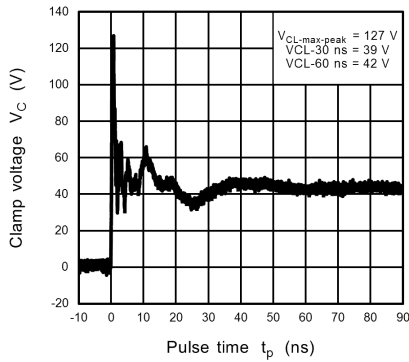

**Fig. 11.20.5 ISO10605
Clamp Waveform +8 kV**

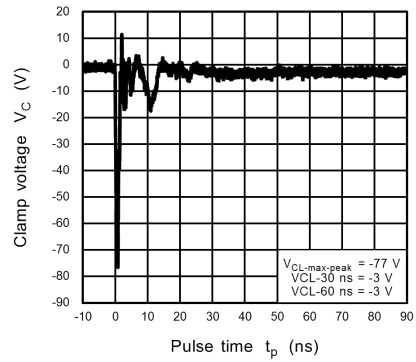

**Fig. 11.20.6 ISO10605
Clamp Waveform -8 kV**

Note: The above characteristics curves are presented for reference only and not guaranteed by production test, unless otherwise noted.

Refer to Fig.11.22.1, Fig.11.22.2, Fig.11.22.3 for peak pulse current(V_C-I_{PP}) and clamp waveform measurement circuit.

11.21. XCEZ36V Characteristics Curves(Note)

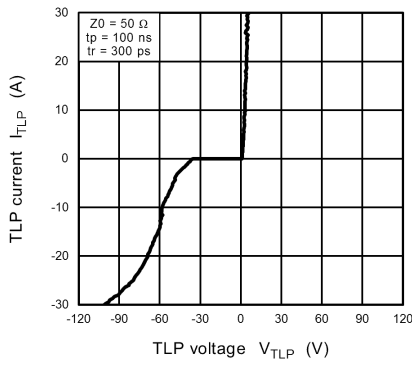

Fig. 11.21.1 $I_{TLP} - V_{TLP}$

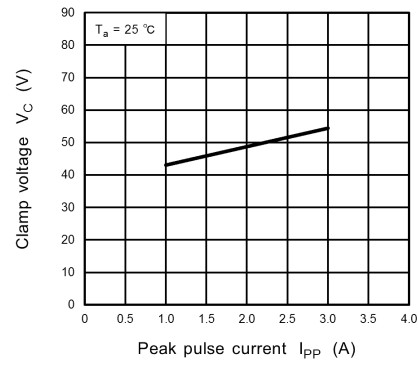
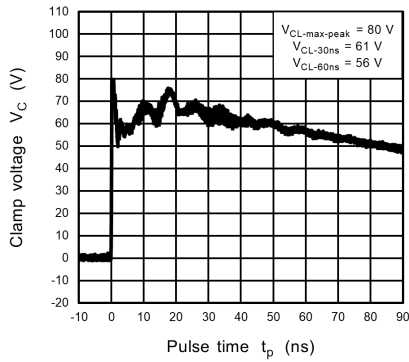
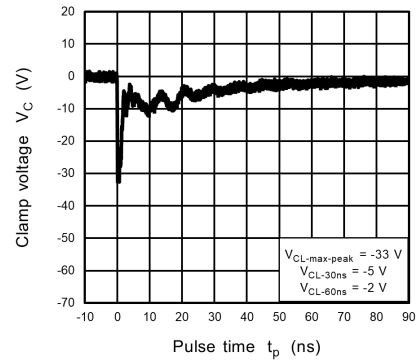

Fig. 11.21.2 $V_C - I_{PP}$



**Fig. 11.21.3 IEC61000-4-2
Clamp Waveform +8 kV**



**Fig. 11.21.4 IEC61000-4-2
Clamp Waveform -8 kV**

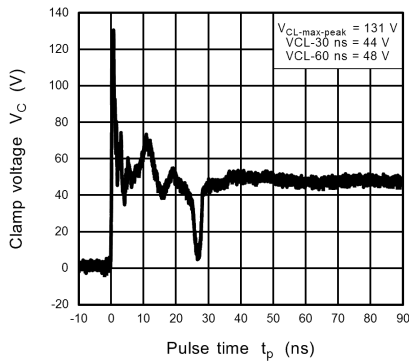

**Fig. 11.21.5 ISO10605
Clamp Waveform +8 kV**

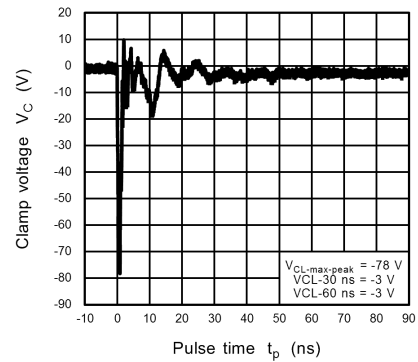

**Fig. 11.21.6 ISO10605
Clamp Waveform -8 kV**

Note: The above characteristics curves are presented for reference only and not guaranteed by production test, unless otherwise noted.

Refer to Fig.11.22.1, Fig.11.22.2, Fig.11.22.3 for peak pulse current(V_C-I_{PP}) and clamp waveform measurement circuit.

11.22. V_C - I_{PP} Peak Pulse and Clamp waveform measurement circuit

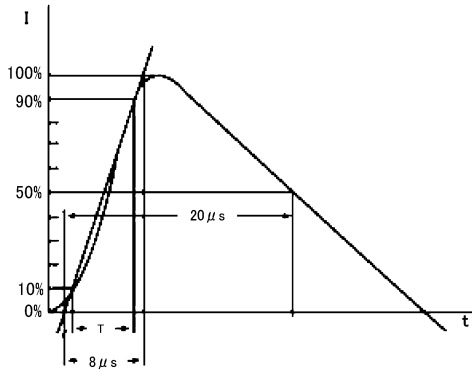

Fig. 11.22.1 V_C - I_{PP} Peak Pulse Current (according to IEC61000-4-5 8/20 μs pulse)

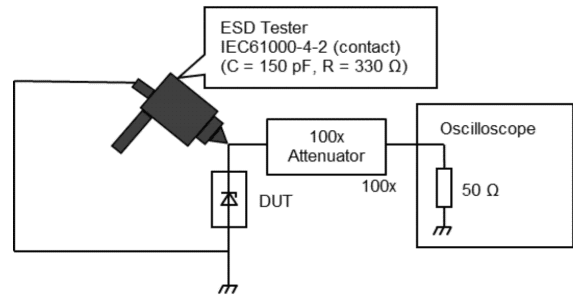

Fig. 11.22.2 Clamp waveform measurement circuit (according to IEC61000-4-2)

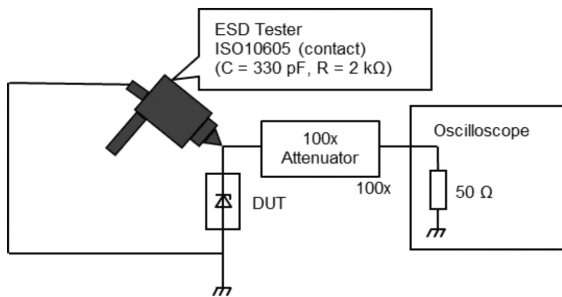
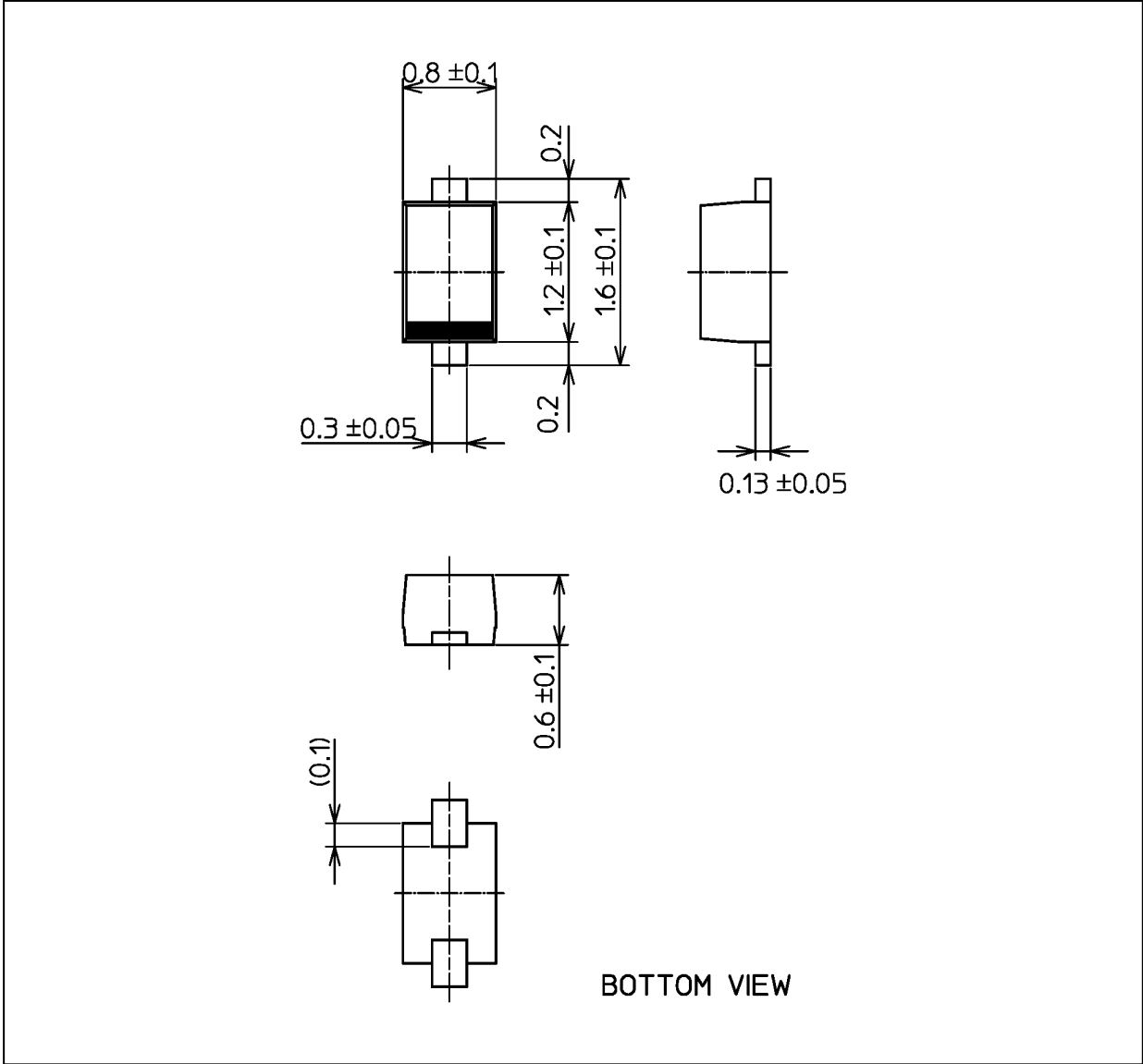

Fig. 11.22.3 Clamp waveform measurement circuit (according to ISO10605)

Package Dimensions

Unit: mm



Weight: 1.4 mg (typ.)

Package Name(s)
JEDEC: SOD-523
Nickname: ESC

RESTRICTIONS ON PRODUCT USE

Toshiba Corporation and its subsidiaries and affiliates are collectively referred to as "TOSHIBA".

Hardware, software and systems described in this document are collectively referred to as "Product".

- TOSHIBA reserves the right to make changes to the information in this document and related Product without notice.
- This document and any information herein may not be reproduced without prior written permission from TOSHIBA. Even with TOSHIBA's written permission, reproduction is permissible only if reproduction is without alteration/omission.
- Though TOSHIBA works continually to improve Product's quality and reliability, Product can malfunction or fail. Customers are responsible for complying with safety standards and for providing adequate designs and safeguards for their hardware, software and systems which minimize risk and avoid situations in which a malfunction or failure of Product could cause loss of human life, bodily injury or damage to property, including data loss or corruption. Before customers use the Product, create designs including the Product, or incorporate the Product into their own applications, customers must also refer to and comply with (a) the latest versions of all relevant TOSHIBA information, including without limitation, this document, the specifications, the data sheets and application notes for Product and the precautions and conditions set forth in the "TOSHIBA Semiconductor Reliability Handbook" and (b) the instructions for the application with which the Product will be used with or for. Customers are solely responsible for all aspects of their own product design or applications, including but not limited to (a) determining the appropriateness of the use of this Product in such design or applications; (b) evaluating and determining the applicability of any information contained in this document, or in charts, diagrams, programs, algorithms, sample application circuits, or any other referenced documents; and (c) validating all operating parameters for such designs and applications. **TOSHIBA ASSUMES NO LIABILITY FOR CUSTOMERS' PRODUCT DESIGN OR APPLICATIONS.**
- **PRODUCT IS NEITHER INTENDED NOR WARRANTED FOR USE IN EQUIPMENTS OR SYSTEMS THAT REQUIRE EXTRAORDINARILY HIGH LEVELS OF QUALITY AND/OR RELIABILITY, AND/OR A MALFUNCTION OR FAILURE OF WHICH MAY CAUSE LOSS OF HUMAN LIFE, BODILY INJURY, SERIOUS PROPERTY DAMAGE AND/OR SERIOUS PUBLIC IMPACT ("UNINTENDED USE").** Except for specific applications as expressly stated in this document, Unintended Use includes, without limitation, equipment used in nuclear facilities, equipment used in the aerospace industry, and lifesaving and/or life supporting medical equipment. **IF YOU USE PRODUCT FOR UNINTENDED USE, TOSHIBA ASSUMES NO LIABILITY FOR PRODUCT.** For details, please contact your TOSHIBA sales representative or contact us via our website.
- Do not disassemble, analyze, reverse-engineer, alter, modify, translate or copy Product, whether in whole or in part.
- Product shall not be used for or incorporated into any products or systems whose manufacture, use, or sale is prohibited under any applicable laws or regulations.
- The information contained herein is presented only as guidance for Product use. No responsibility is assumed by TOSHIBA for any infringement of patents or any other intellectual property rights of third parties that may result from the use of Product. No license to any intellectual property right is granted by this document, whether express or implied, by estoppel or otherwise.
- **ABSENT A WRITTEN SIGNED AGREEMENT, EXCEPT AS PROVIDED IN THE RELEVANT TERMS AND CONDITIONS OF SALE FOR PRODUCT, AND TO THE MAXIMUM EXTENT ALLOWABLE BY LAW, TOSHIBA (1) ASSUMES NO LIABILITY WHATSOEVER, INCLUDING WITHOUT LIMITATION, INDIRECT, CONSEQUENTIAL, SPECIAL, OR INCIDENTAL DAMAGES OR LOSS, INCLUDING WITHOUT LIMITATION, LOSS OF PROFITS, LOSS OF OPPORTUNITIES, BUSINESS INTERRUPTION AND LOSS OF DATA, AND (2) DISCLAIMS ANY AND ALL EXPRESS OR IMPLIED WARRANTIES AND CONDITIONS RELATED TO SALE, USE OF PRODUCT, OR INFORMATION, INCLUDING WARRANTIES OR CONDITIONS OF MERCHANTABILITY, FITNESS FOR A PARTICULAR PURPOSE, ACCURACY OF INFORMATION, OR NON-INFRINGEMENT.**
- Do not use or otherwise make available Product or related software or technology for any military purposes, including without limitation, for the design, development, use, stockpiling or manufacturing of nuclear, chemical, or biological weapons or missile technology products (mass destruction weapons). Product and related software and technology may be controlled under the applicable export laws and regulations including, without limitation, the Japanese Foreign Exchange and Foreign Trade Law and the U.S. Export Administration Regulations. Export and re-export of Product or related software or technology are strictly prohibited except in compliance with all applicable export laws and regulations.
- Please contact your TOSHIBA sales representative for details as to environmental matters such as the RoHS compatibility of Product. Please use Product in compliance with all applicable laws and regulations that regulate the inclusion or use of controlled substances, including without limitation, the EU RoHS Directive. **TOSHIBA ASSUMES NO LIABILITY FOR DAMAGES OR LOSSES OCCURRING AS A RESULT OF NONCOMPLIANCE WITH APPLICABLE LAWS AND REGULATIONS.**

Mouser Electronics

Authorized Distributor

Click to View Pricing, Inventory, Delivery & Lifecycle Information:

[Toshiba:](#)

[XCEZ9V1,L3XHF](#)