

POS. 1 PART-NO.: 15494612
CODING / CODIERUNG Z

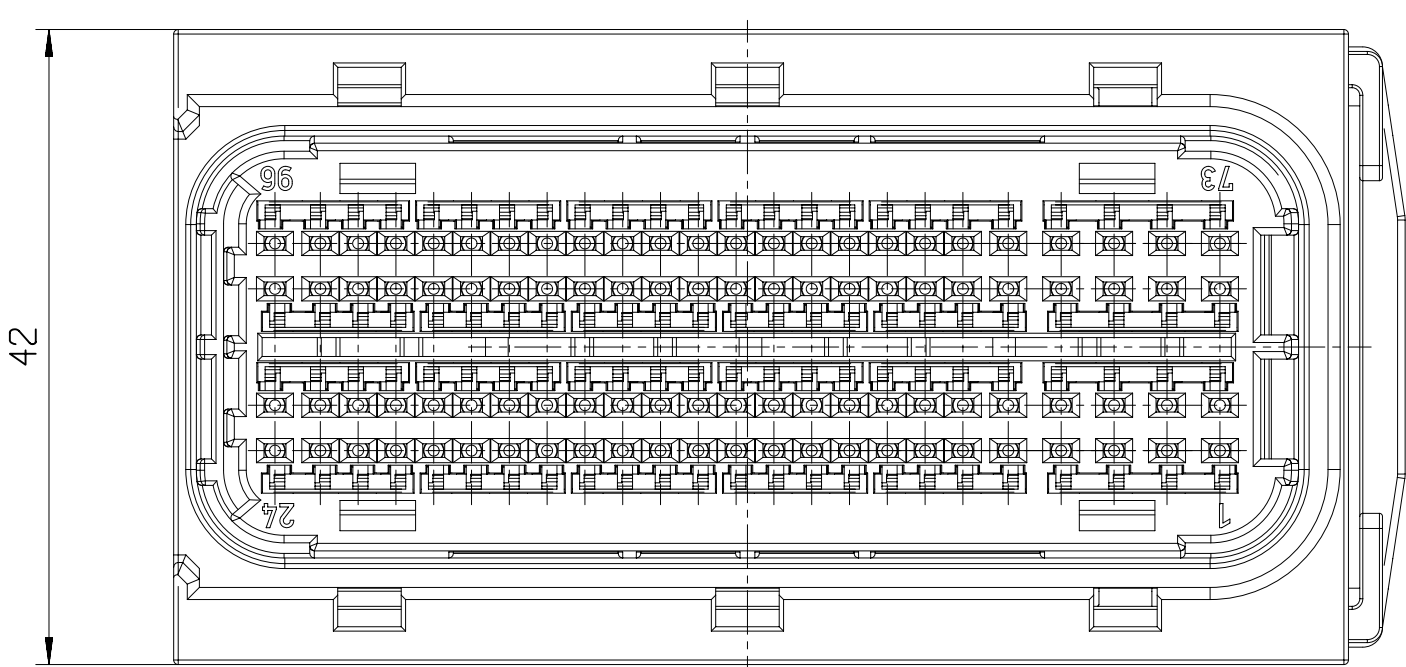

POS	TITLE	PART-NO.:	PART-REV	DATE	DATE	AMOUNT	CUSTOMER-NO.:	MATERIAL	NOTES
Z	BENENNUNG	REV	REV	DATUM	DATUM	ANZAHL	KUNDENNUMMER	WERKSTOFF	BEMERKUNG
1	CONNECTOR 96 WAY	15494612	01	25JUN07	42	1	---	---	CONDITION OF DELIVERY POS. 1-2 ASSEMBLED
2	RECEPTACLE HOUSING 96 WAY	15494612	---	---	---	1	---	---	LIEFERZUSTAND POS. 1-2 MONTIERT
2	FLACHSTECKHUELSENGEHAUESE 96 POL.	15494612	---	---	---	1	---	---	ONLY ASSEMBLED PARTS AVAILABLE
2	COVER PLATE AND BLOCK/SEAL	---	---	---	---	1	---	---	NUR MONTIERT LIEFERBAR
2	ABDECKPLATTE UND BLOCKDICHTUNG	---	---	---	---	1	---	---	ONLY ASSEMBLED PARTS AVAILABLE
2	---	---	---	---	---	1	---	---	NUR MONTIERT LIEFERBAR

COD	PART-NO.:	PART-REV	DATE	VARIANT-NO.:	SCALE/ASSISTAB
Z	15494598	02	16DEC05	0	2:1
2	15494610	---	---	0	3

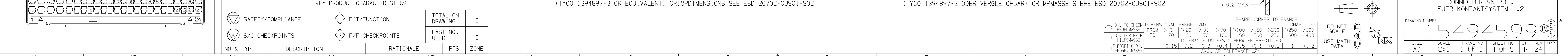
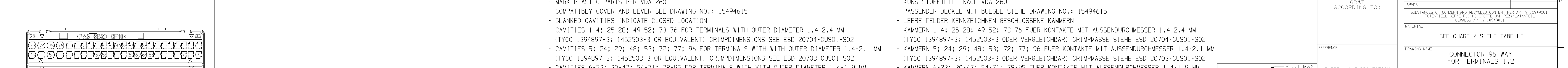
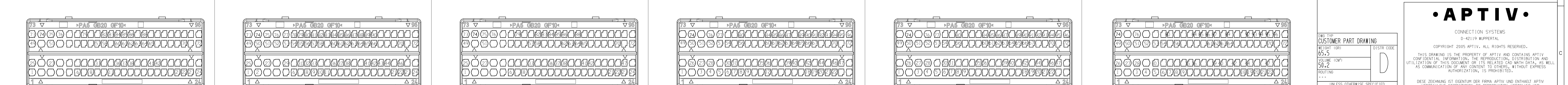
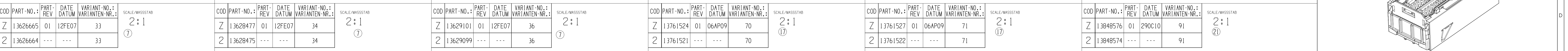
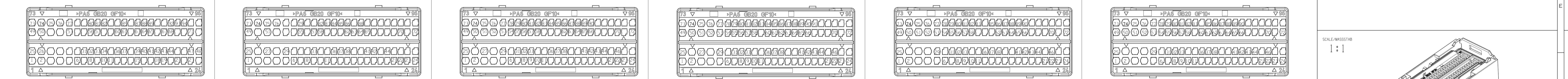
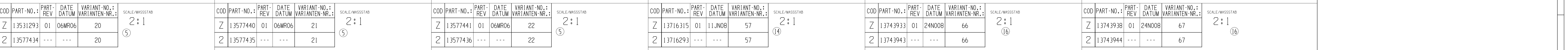
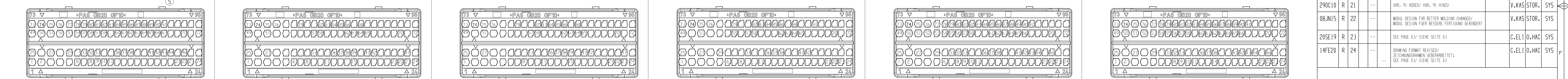
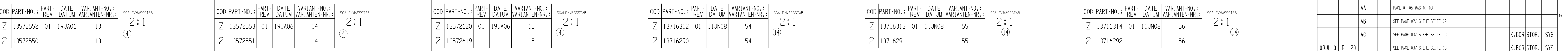
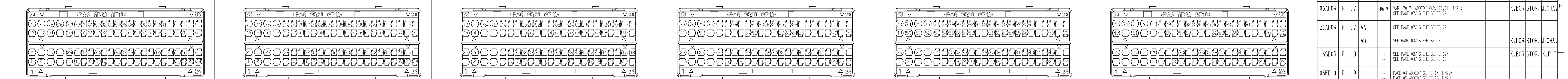
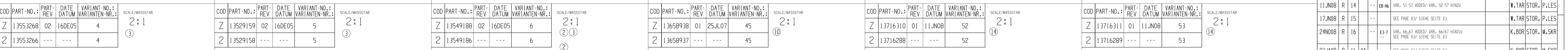
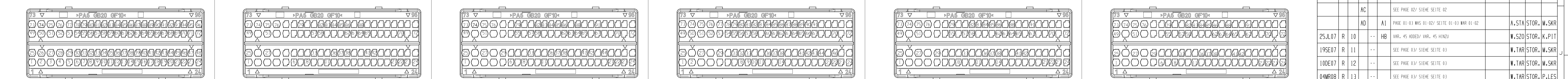

REMARKS:
 - IN CASE OF PART MODIFICATION CHECK ASSEMBLY TOOLS AND TEST EQUIPMENT AT THE CUSTOMER AND THE SUPPLIER
 - MARK PLASTIC PARTS PER VDA 260
 - COMPATIBLY COVER AND LEVER SEE DRAWING NO.: 15494615
 - BLANKED CAVITIES INDICATE CLOSED LOCATION
 - CAVITIES 1-4; 25-28; 49-52; 73-76 FOR TERMINALS WITH OUTER DIAMETER 1.4-2.4 MM (TYCO 1394897-3; 1452503-3 OR EQUIVALENT) CRIMP DIMENSIONS SEE ESD 20704-CUS01-502
 - CAVITIES 5; 24; 29; 48; 53; 72; 77; 96 FOR TERMINALS WITH WITH OUTER DIAMETER 1.4-2.1 MM (TYCO 1394897-3; 1452503-3 OR EQUIVALENT) CRIMP DIMENSIONS SEE ESD 20703-CUS01-502
 - CAVITIES 6-23; 30-47; 54-71; 78-95 FOR TERMINALS WITH WITH OUTER DIAMETER 1.4-1.9 MM (TYCO 1394897-3 OR EQUIVALENT) CRIMP DIMENSIONS SEE ESD 20702-CUS01-502

BEMERKUNGEN:
 - BEI ARTIKELÄNDERUNG AUF MONTAGE UND PRUEFEQUIPMENT BEIM KUNDEN SOWIE BEIM LIEFERANTEN ACHTEN
 - KUNSTSTOFFTEILE NACH VDA 260
 - PASSENDER DECKEL MIT BUEGEL SIEHE DRAWING-NO.: 15494615
 - LEERE FELDER KENNZEICHNEN GESCHLOSSENE KAMMERN
 - KAMMERN 1-4; 25-28; 49-52; 73-76 FUER KONTAKTE MIT AUSSENDENDURCHMESSER 1.4-2.4 MM (TYCO 1394897-3; 1452503-3 ODER VERGLEICHBARI) CRIMPMASSSE SIEHE ESD 20704-CUS01-502
 - KAMMERN 5; 24; 29; 48; 53; 72; 77; 96 FUER KONTAKTE MIT AUSSENDENDURCHMESSER 1.4-2.1 MM (TYCO 1394897-3; 1452503-3 ODER VERGLEICHBARI) CRIMPMASSSE SIEHE ESD 20703-CUS01-502
 - KAMMERN 6-23; 30-47; 54-71; 78-95 FUER KONTAKTE MIT AUSSENDENDURCHMESSER 1.4-1.9 MM (TYCO 1394897-3 ODER VERGLEICHBARI) CRIMPMASSSE SIEHE ESD 20702-CUS01-502

NO & TYPE	DESCRIPTION	RATIONALE	PTS	ZONE
SAFETY/COMPLIANCE	FIT/FUNCTION		0	
S/C CHECKPOINTS	F/F CHECKPOINTS		0	
TOTAL ON DRAWING	LAST NO. USED		0	

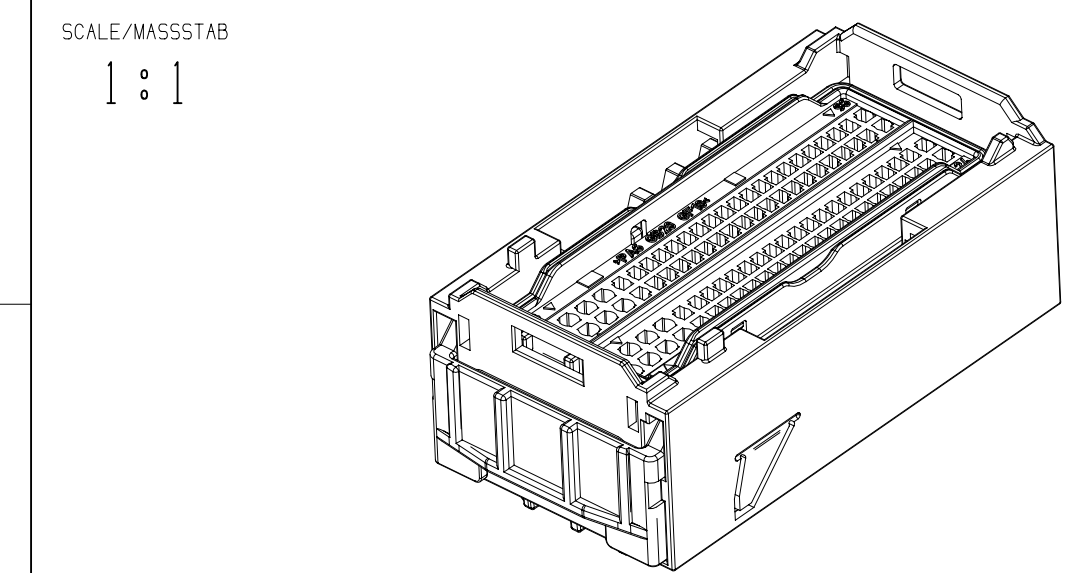

APTIV

CONNECTION SYSTEMS
 D-42119 WUPPERTAL

CUSTOMER PART DRAWING
 REF: 05.5
 DATE: 18JAN05
 DRAWING NO.: 15494599

UNLESS OTHERWISE SPECIFIED

GENERAL TOLERANCES ACCORDING TO:

GD&T ACCORDING TO:

REFERENCE:

FIRST ANGLE PROJECTION

DO NOT SCALE
 USE MATH DATA

MATERIAL: SEE CHART / SIEHE TABELLE

DRAWING NAME: CONNECTOR 96 WAY FOR TERMINALS 1.2
 FUER KONTAKTSTYPER 1.2

DRAWING NUMBER: 15494599 (9)

DATE: 18JAN05
 APD01: M.SKR
 APD02: M.SKR
 APD03: M.SKR
 APD04: M.SKR

SUBSTANCES OF CONCERN AND RECYCLED CONTENT PER APTIV 10040001
 POTENTIAL BEFÄHRIGUNGSGEFÄHRDUNG UND REZUKLANTEIL
 GEWISS APTIV 10040001

SIZE: A2
 SCALE: 2:1
 SHEET NO: 1 OF 1
 STB: 1
 REV: 1
 NVP: 24

Mouser Electronics

Authorized Distributor

Click to View Pricing, Inventory, Delivery & Lifecycle Information:

[Aptiv:](#)

[13535335](#)