

# Antenna

# YKB001AA Datasheet

OC:YKB001AA



# About the Document

## Revision History

Version	Date	Author	Note
1.0	2020-11-02	Kenny YIN	Initial

---

---

## Contents

About the Document.....	1
Contents.....	1
<b>1 Product Description.....</b>	<b>2</b>
<b>2 Product Features.....</b>	<b>2</b>
<b>3 Product Specifications.....</b>	<b>3</b>
<b>4 Overall Performance.....</b>	<b>4</b>
4.1. Test Environment.....	4
4.2. VSWR.....	5
4.3. Efficiency.....	6
4.4. Gain.....	7
4.5. Radiation Patterns.....	8
<b>5 Product Size.....</b>	<b>14</b>

## 1 Product Description

The antenna is designed for superior performance, and can be widely used for wireless applications.

We provide comprehensive antenna design support such as simulation, testing and manufacturing for custom antenna solutions to meet your specific application needs.

## 2 Product Features

- Cellular LTE
- High efficiency
- Excellent performance

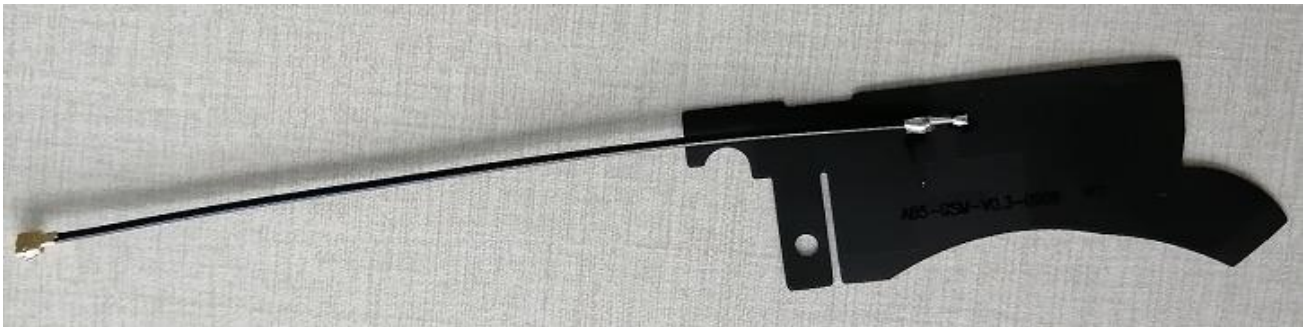

### 3 Product Specifications

#### Passive Electrical Specifications

Frequency Range	824–2700 MHz
Input Impedence	50 $\Omega$
VSWR	$\leq 3.0$
Gain	$\leq 5$ dBi
Polarization Type	Linear

#### Mechanical Specifications

Antenna Size (mm)	69.32 mm $\times$ 24.96 mm
Connect Type	IPEX MHF I
Working Temperature	-20 $^{\circ}$ C to +85 $^{\circ}$ C
Radome Color	Black

## 4 Overall Performance

### 4.1. Test Environment

- KEYSIGHT VNA Network Analyzer E5063A 100 kHz – 6.5 GHz
- RayZone® 2800 Chamber 5G (FR1) SISO/MIMO, 400 MHz – 6.0 GHz



## 4.2. VSWR

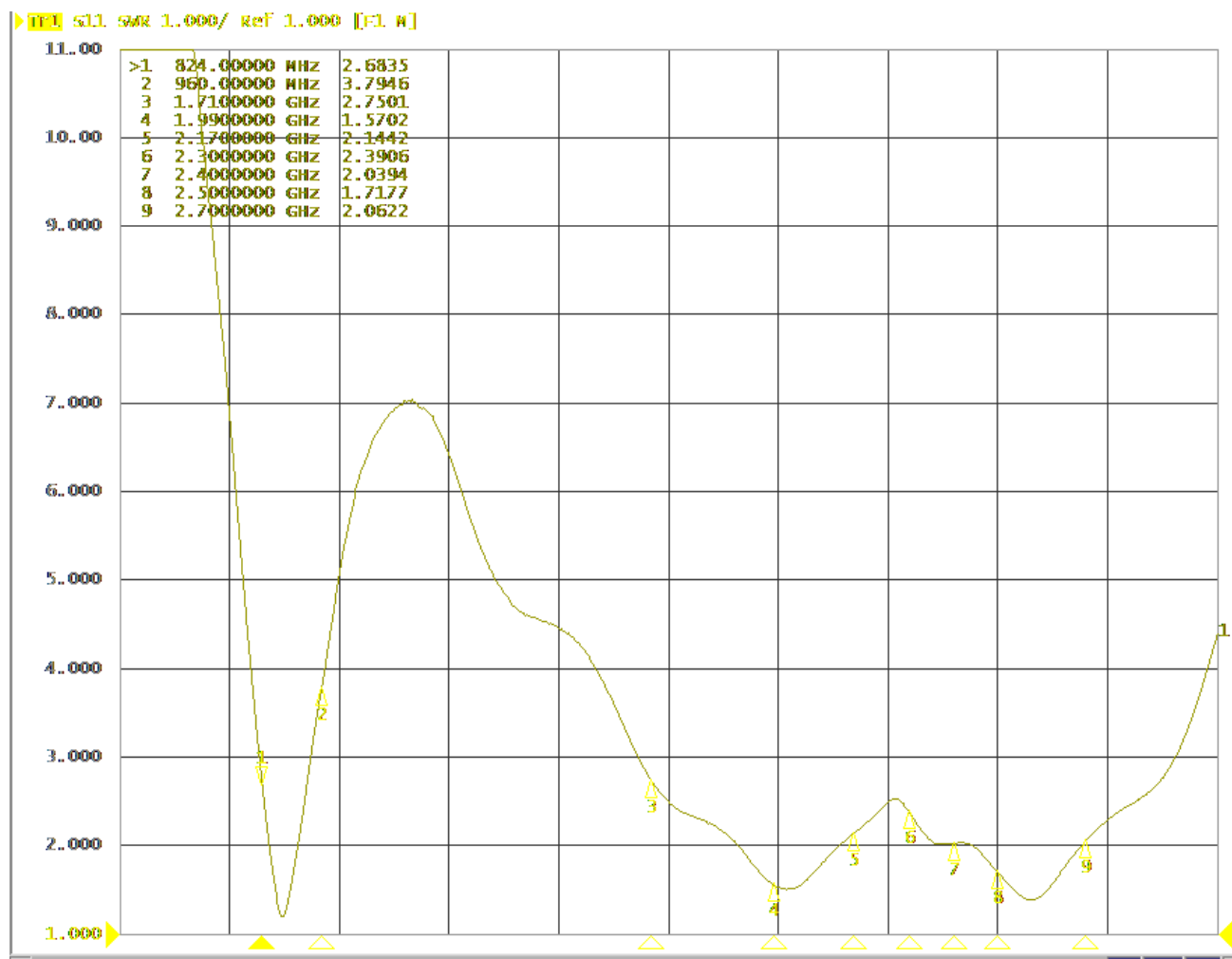

Frequency (MHz)	824	960	1710	2170	2300	2700
VSWR	2.6	3.7	2.7	2.1	2.3	2.0

### 4.3. Efficiency

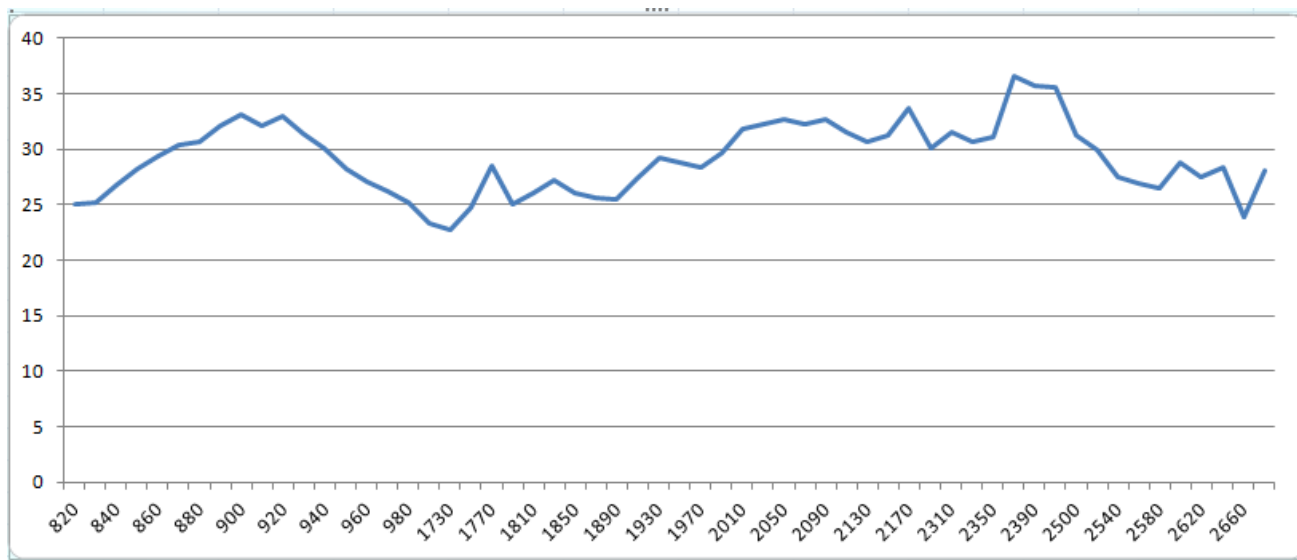

<b>Frequency (MHz)</b>	824	960	1710	2170	2300	2700
<b>Efficiency (%)</b>	25	27	23	33	30	28

## 4.4. Gain

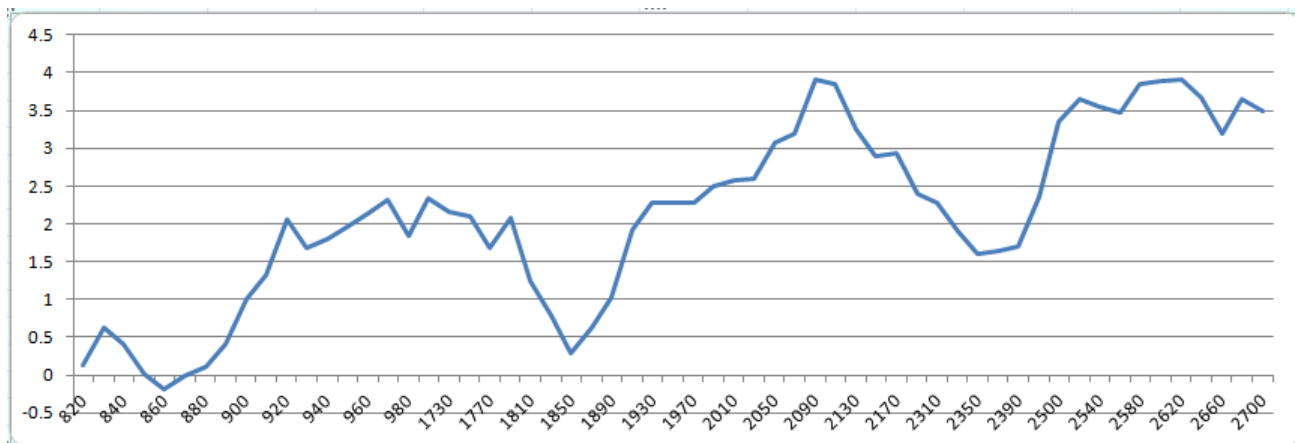

<b>Frequency (MHz)</b>	824	960	1710	2170	2300	2700
<b>Gain (dBi)</b>	0.16	2.12	2.34	2.97	2.3	3.4

### 4.5. Radiation Patterns

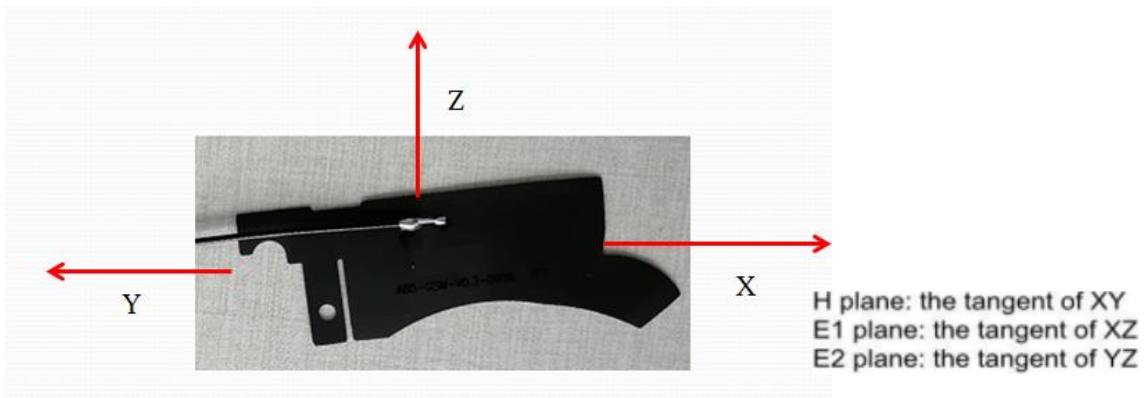

824MHz

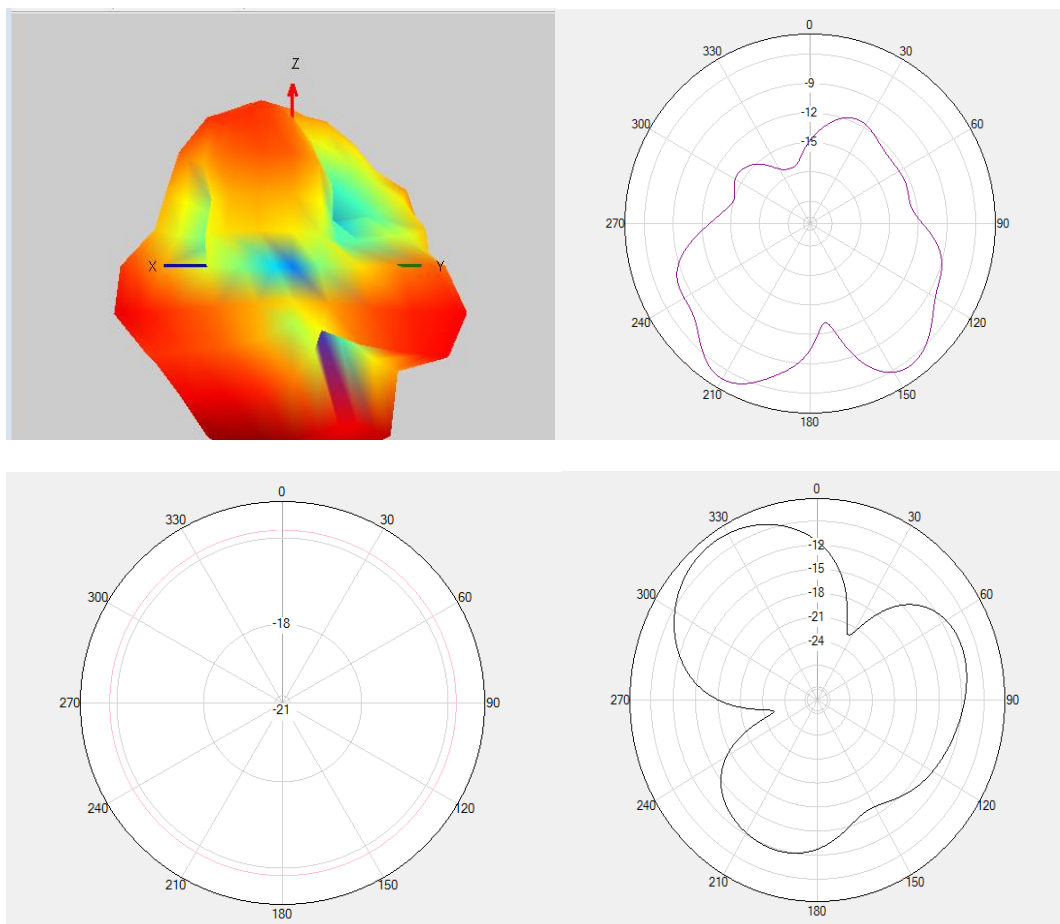

# 960MHz

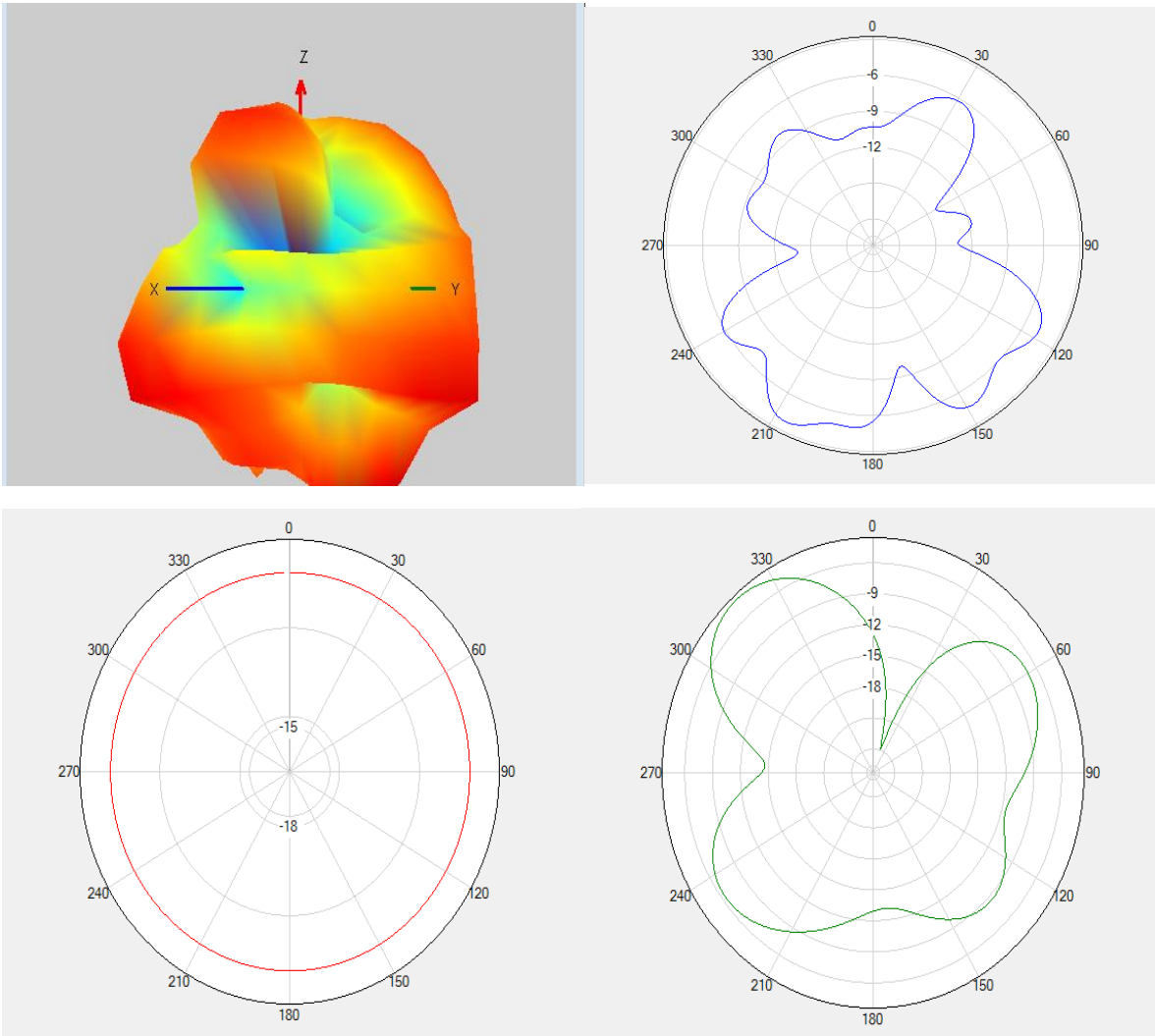

# 1710MHz

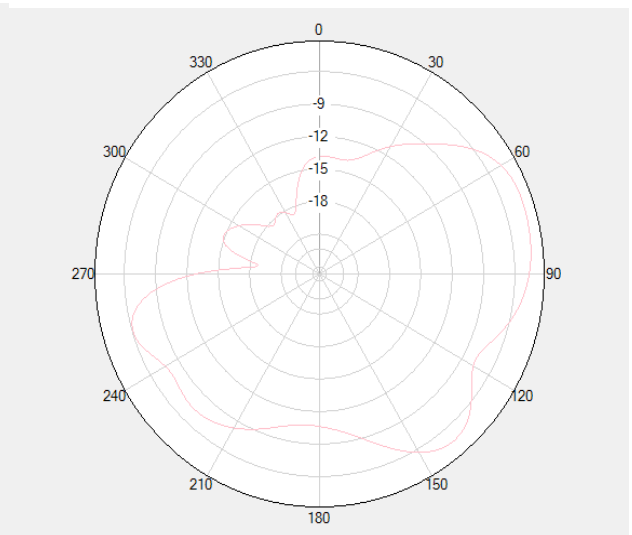
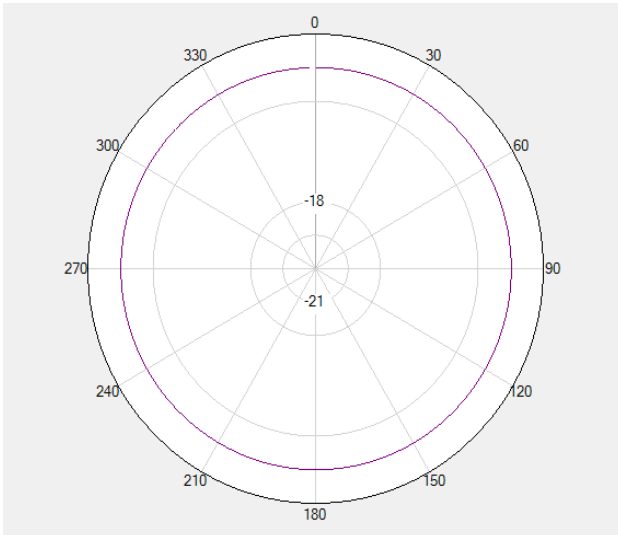
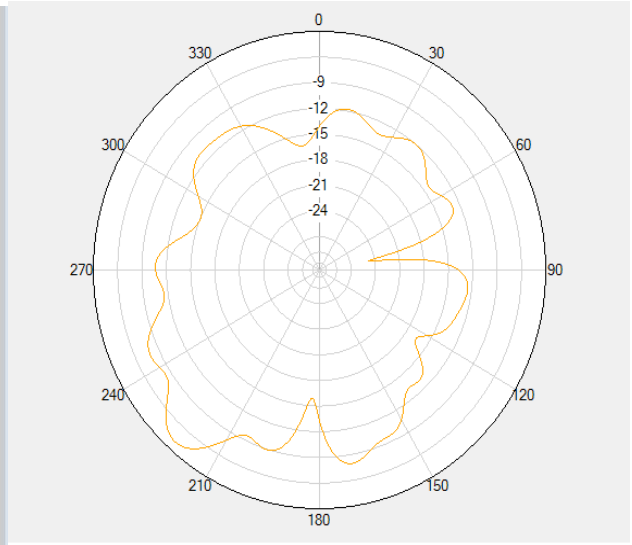
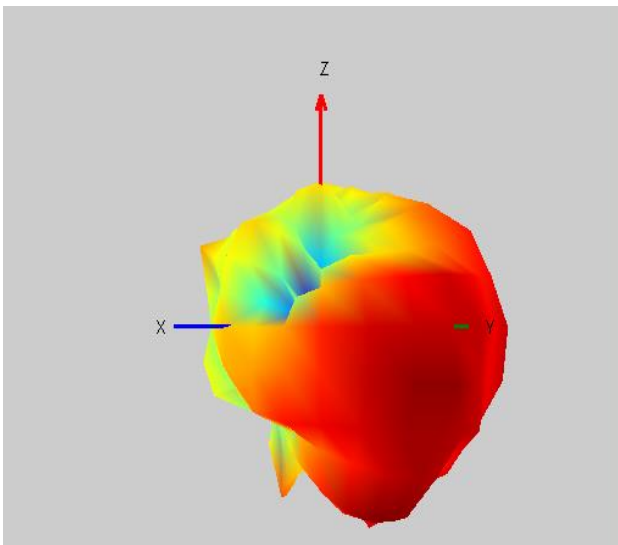

# 2170MHz

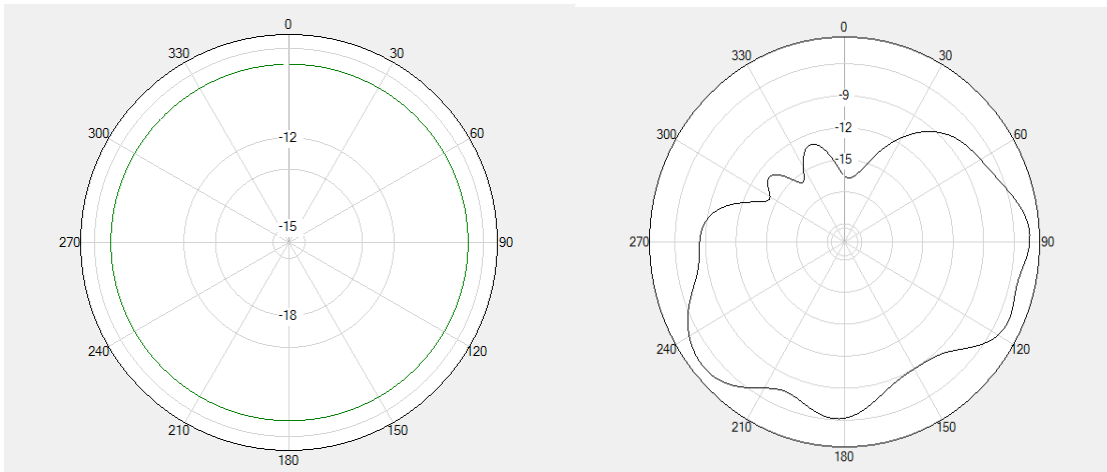
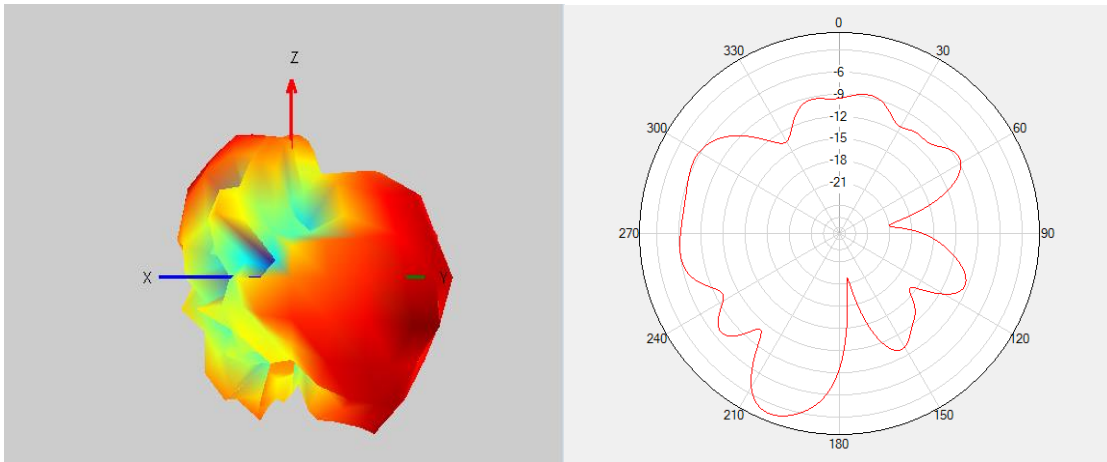

# 2300MHz

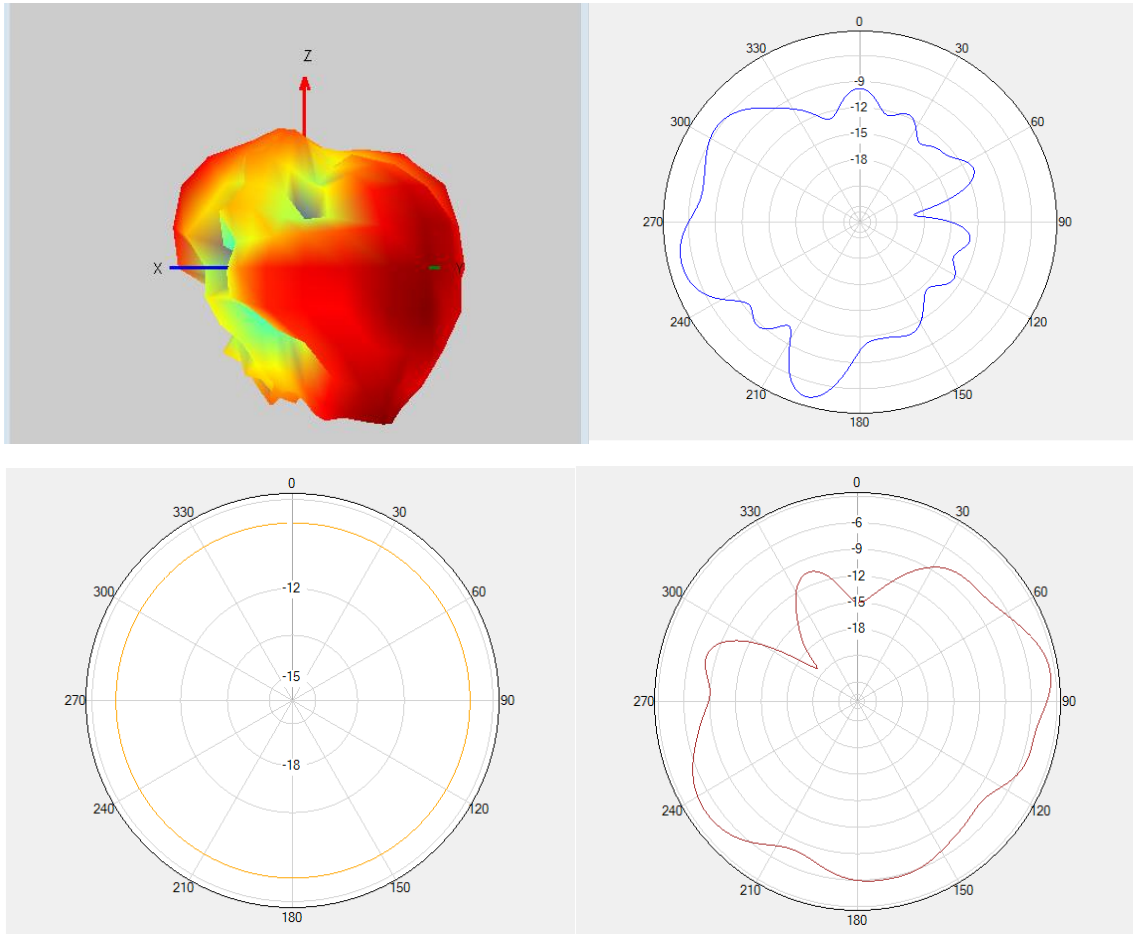

## 2700MHz

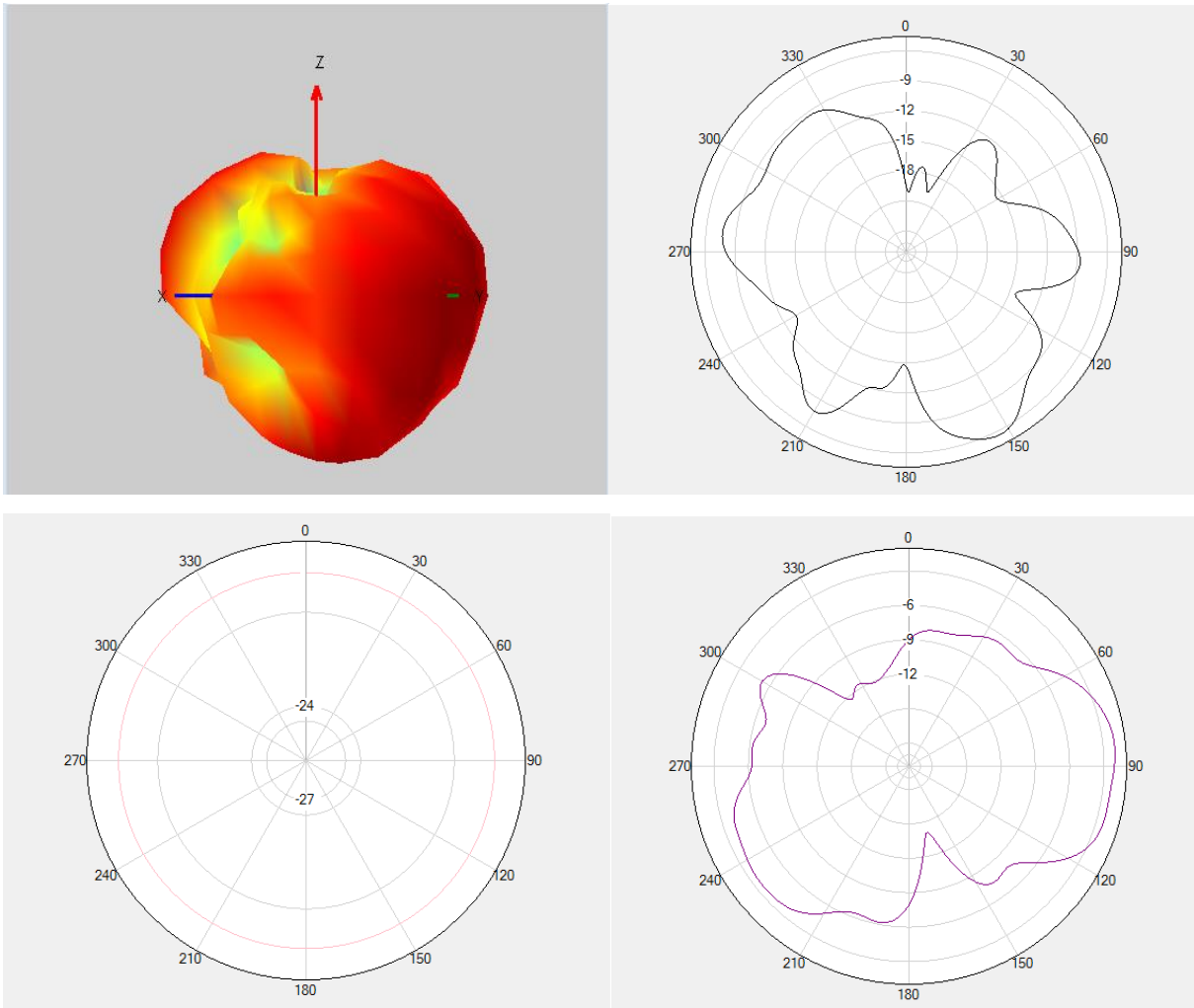

## 5 Product Size

RoHS

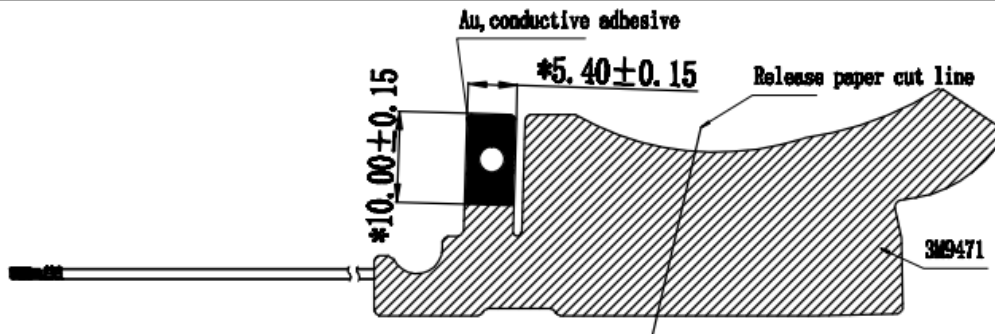
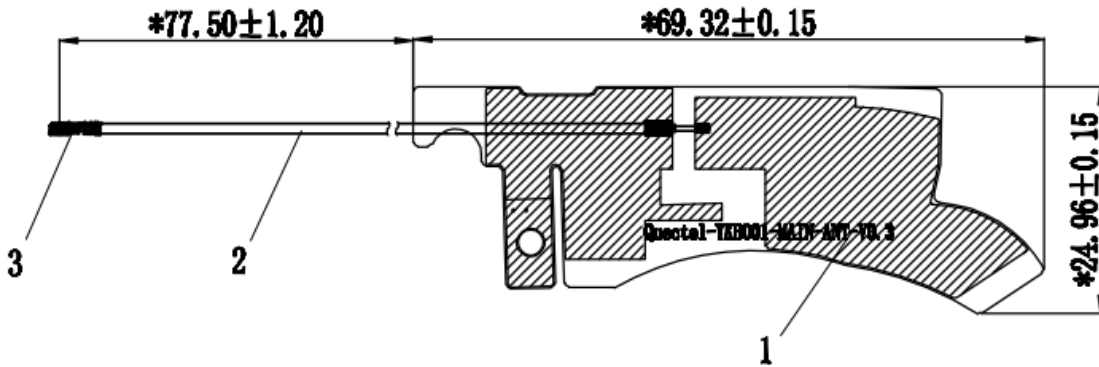

No	Item	Spec
1	FPC	PI, 3M9471, Double Side
2	Cable	∅1.13mm, Black, L=110mm
3	Connector	MHF I-IPEX