

LMK6x Low Jitter, High-Performance BAW Oscillator

1 Features

- High-performance differential and single-ended output Oscillator, supporting any fixed frequency within the below range:
 - LMK6D: 1MHz to 400MHz, LVDS output
 - LMK6H: 1MHz to 400MHz, HCSL output
 - LMK6P: 1MHz to 400MHz, LVPECL output
 - LMK6C: 1MHz to 200MHz, LVCMOS output
- Ultra-low jitter:
 - LMK6D/LMK6H/LMK6P: 100fs typical / 125fs maximum RMS jitter at 156.25MHz (12kHz to 20MHz)
 - LMK6C: 350fs typical / 500fs maximum RMS jitter at 100MHz (12kHz to 20MHz)
 - LMK6H: PCIe Gen 1 to Gen 7 compliant
- ±25ppm total frequency stability inclusive of 10 years aging and all other factors
- Smallest industry standard DLE and DLF packages
- Support extended industrial temperature grade:
 - LMK6P/LMK6D/LMK6H: –40°C to 85°C
 - LMK6C: –40°C to 105°C
- Integrated LDO for robust supply noise immunity:
 - 72dBc PSRR at 500kHz ripple
- Start-up time: < 5ms
- Standard frequencies:
 - LVCMOS (MHz): 1, 2.04, 4, 8.192, 10, 12, 12.288, 16, 19.2, 20, 23.5, 24, 24.57, 25, 25.6, 26, 26.21, 27, 28.12, 32.768, 33.333, 40, 48, 49.15, 50, 54, 60, 65.53, 66, 74.25, 76.8, 80, 100, 108, 125, 133.330 and 156.25
 - Differential (MHz): 25, 26, 32.5, 50, 51.84, 54, 65, 76.8, 80, 100, 108, 122.88, 125, 133.330, 148.35, 148.5, 150, 155.52, 156.25, 161.1328125, 200, 312.5, and 400
- Device can support any frequency between 1MHz to 400MHz. Contact TI representative for any frequency and samples needed

2 Applications

- 56G/112G PAM4 clocking
- 100G/200G/400G/800G Optical Transport Network and Coherent Optics
- Wired Networking, switches, routers, line cards, SAN, data centers and baseband units (BBU)
- PCIe Gen 1 to Gen 7 compliant reference clock
- Industrial applications
- Test and measurement
- ASIC, FPGA, MCU reference clocking
- High-performance crystal oscillator replacement

3 Description

Texas Instruments' Bulk-Acoustic Wave (BAW) is a micro-resonator technology that enables integration of high-precision BAW resonator directly into packages with ultra-low jitter clock circuitry. BAW is fully designed and manufactured at TI factories like other silicon-based fabrication processes.

The LMK6x device is an ultra-low jitter, fixed-frequency oscillator which incorporates the BAW as the resonator source. The device is factory-programmed per specific operation mode, including frequency, voltage, output type, and function pin. With a high-performance fractional frequency divider, the LMK6x is capable of producing any frequency within the specified range providing a single device family for all frequency needs.

The high-performance clocking, mechanical stability, flexibility, and small package options for this device are designed for reference and core clocks in high-speed SERDES used in telecommunications, data and enterprise network, and industrial applications.

Package Information

PART NUMBER	OUTPUT TYPE	PACKAGE ⁽¹⁾	PACKAGE SIZE ⁽²⁾
LMK6C	LVCMOS	VSON (DLE-4)	3.2mm × 2.5mm
LMK6C		VSON (DLF-4)	2.5mm × 2mm
LMK6D LMK6H LMK6P	LVDS, HCSL, LVPECL	VSON (DLE-6)	3.2mm × 2.5mm
LMK6D LMK6H LMK6P		VSON (DLF-6)	2.5mm × 2mm

- For all available packages, see [Section 12](#).
- The package size (length × width) is a nominal value and includes pins, where applicable.

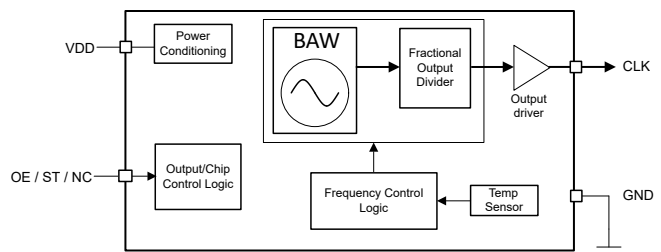

LMK6C Simplified Block Diagram



Table of Contents

1 Features	1	8.2 Functional Block Diagram.....	22
2 Applications	1	8.3 Feature Description.....	22
3 Description	1	8.4 Device Functional Modes.....	28
4 Device Ordering Information	3	9 Application and Implementation	28
5 Pin Configuration and Functions	5	9.1 Application Information.....	28
6 Specifications	6	9.2 Typical Application.....	28
6.1 Absolute Maximum Ratings.....	6	9.3 Power Supply Recommendations.....	32
6.2 ESD Ratings.....	6	9.4 Layout.....	32
6.3 Environmental Compliance.....	6	10 Device and Documentation Support	36
6.4 Recommended Operating Conditions.....	6	10.1 Documentation Support.....	36
6.5 Thermal Information.....	7	10.2 Receiving Notification of Documentation Updates..	36
6.6 Thermal Information.....	7	10.3 Support Resources.....	36
6.7 Electrical Characteristics.....	8	10.4 Trademarks.....	36
6.8 Timing Diagrams.....	14	10.5 Electrostatic Discharge Caution.....	36
6.9 Typical Characteristics.....	15	10.6 Glossary.....	36
7 Parameter Measurement Information	20	11 Revision History	36
7.1 Device Output Configurations.....	20	12 Mechanical, Packaging, and Orderable Information	37
8 Detailed Description	22		
8.1 Overview.....	22		

4 Device Ordering Information

Use [Figure 4-1](#) and [Figure 4-2](#) to understand the device nomenclature of the LMK6x orderable options.

The [LMK6x OPN Decoder](#) application note lists all orderable part numbers and the corresponding output frequencies, device top markings, and packaging information.

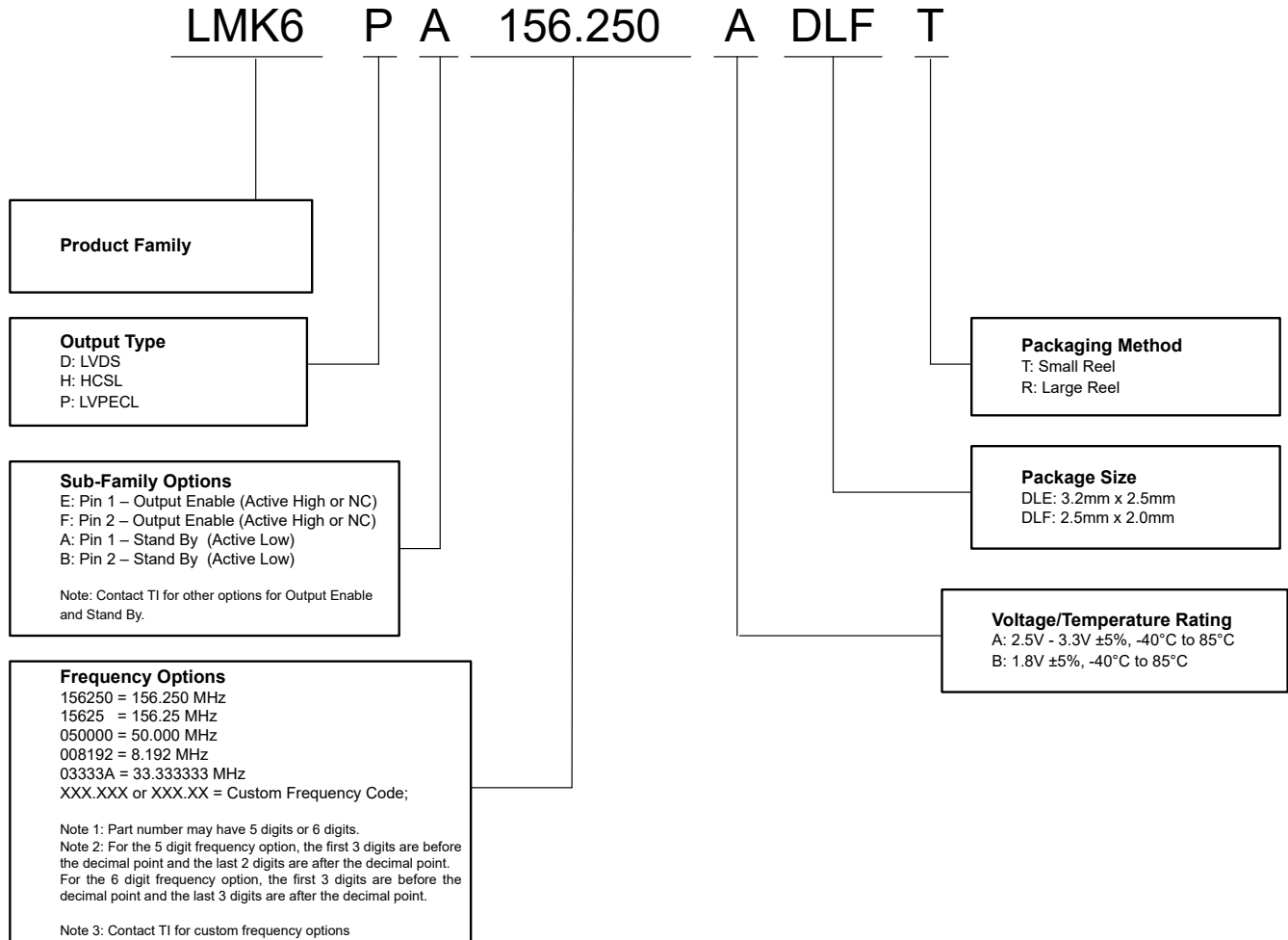

Figure 4-1. Part Number Guide: LMK6D, LMK6H, and LMK6P

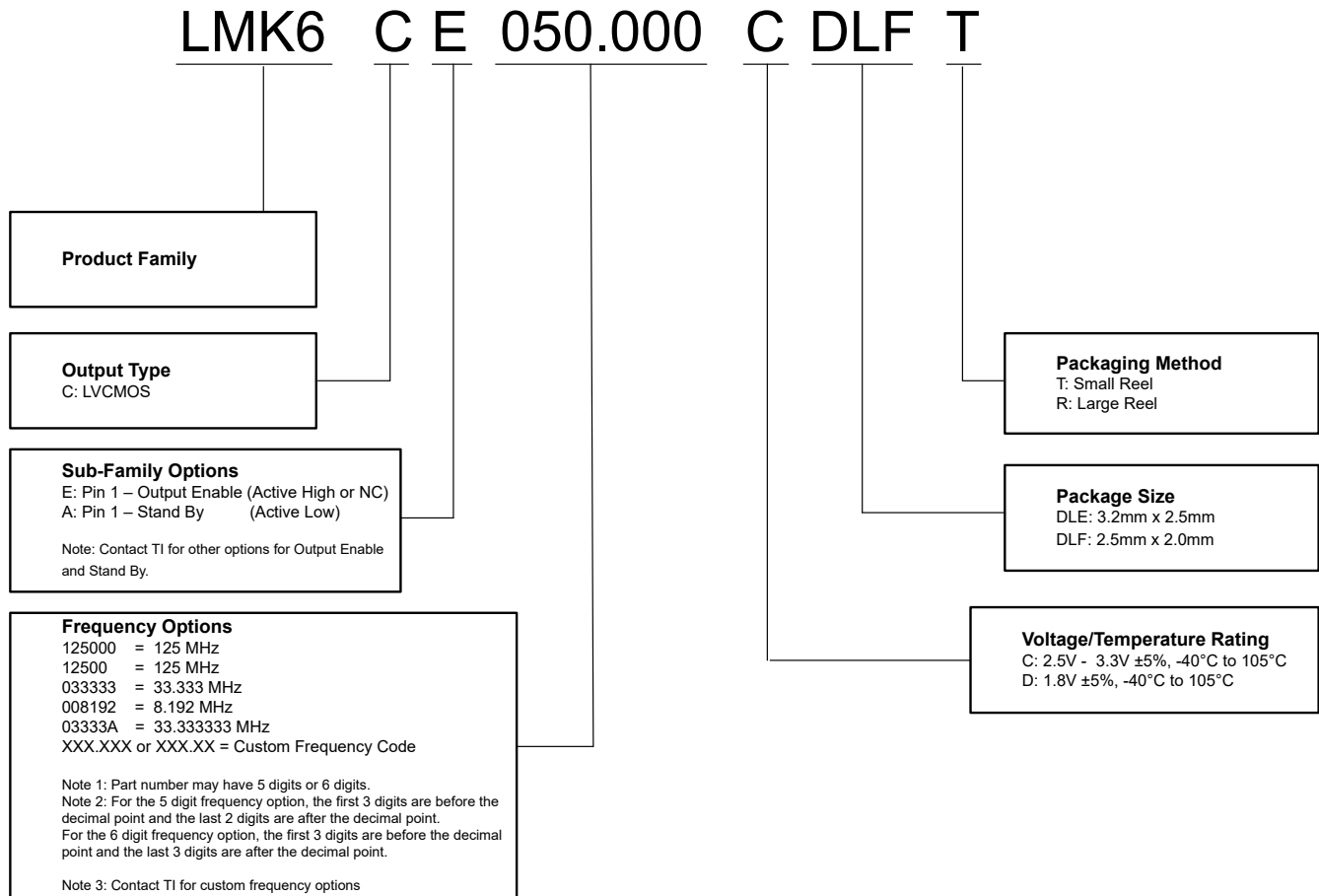

Figure 4-2. Part Number Guide: LMK6C

5 Pin Configuration and Functions

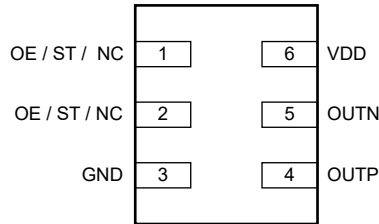

Figure 5-1. LMK6P, LMK6D, or LMK6H 6-Pin VSON (Top View)

Table 5-1. LMK6P, LMK6D, or LMK6H Pin Functions

PIN		Type ⁽¹⁾	DESCRIPTION
NAME	DLE/DLF		
OE / ST / NC	1	I / NC	Output Enable (OE) or Standby (ST) pin or No Connect (NC). See Table 8-1 for more details.
OE / ST / NC	2	NC / I	Output Enable (OE) or Standby (ST) pin or No Connect (NC). See Table 8-1 for more details.
GND	3	G	Device ground
OUTP	4	O	Positive differential output clock
OUTN	5	O	Negative differential output clock
VDD	6	P	Device power supply

(1) I = Input, O = Output, I/O = Input or Output, G = Ground, P = Power, NC = No Connect (can be left floating).

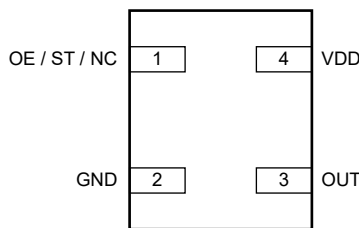

Figure 5-2. LMK6C 4-Pin VSON (Top View)

Table 5-2. LMK6C Pin Functions

PIN		Type ⁽¹⁾	DESCRIPTION
NAME	DLE/DLF		
OE / ST / NC	1	I / NC	Output Enable (OE) or Standby (ST) pin or No Connect (NC). See Table 8-2 for more details.
GND	2	G	Device ground
OUT	3	O	LVCMOS output clock
VDD	4	P	Device power supply

(1) I = Input, O = Output, I/O = Input or Output, G = Ground, P = Power, NC = No Connect (can be left floating).

6 Specifications

6.1 Absolute Maximum Ratings

over operating free-air temperature range (unless otherwise noted)⁽¹⁾

		MIN	MAX	UNIT
VDD	Device Supply Voltage ⁽²⁾	-0.3	3.63	V
	Device Supply Voltage ⁽³⁾	-0.3	1.98	V
EN	Logic Input Voltage	-0.3	VDD + 0.3	V
OUTP, OUTN	Clock Output Voltage ⁽⁴⁾	-0.3	VDD + 0.3	V
OUT	Clock Output Voltage ⁽⁵⁾	-0.3	VDD + 0.3	V
T _J	Junction Temperature		125	°C
T _{STG}	Storage Temperature		150	°C

(1) Operation outside the Absolute Maximum Ratings may cause permanent device damage. Absolute Maximum Ratings do not imply functional operation of the device at these or any other conditions beyond those listed under Recommended Operating Conditions. If used outside the Recommended Operating Conditions but within the Absolute Maximum Ratings, the device may not be fully functional, and this may affect device reliability, functionality, performance, and shorten the device lifetime.

(2) For all devices with Recommended Operating Voltage of 2.5V ± 5% and 3.3V ± 5%

(3) For all devices with Recommended Operating Voltage of 1.8V ± 5%

(4) For all differential outputs - LMK6D, LMK6H, and LMK6P.

(5) For single ended outputs - LMK6C.

6.2 ESD Ratings

			VALUE	UNIT
V _(ESD)	Electrostatic discharge	Human body model (HBM), per ANSI/ESDA/ JEDEC JS-001, all pins ⁽¹⁾	±2000	V
		Charged device model (CDM), per JEDEC JS-002, all pins ⁽²⁾	±500	

(1) JEDEC document JEP155 states that 500V HBM allows safe manufacturing with a standard ESD control process.

(2) JEDEC document JEP157 states that 250V CDM allows safe manufacturing with a standard ESD control process.

6.3 Environmental Compliance

		VALUE	UNIT
Mechanical Shock Resistance	MIL-STD-883F, Method 2002, Condition A	1500	g
Mechanical Vibration Resistance	MIL-STD-883F, Method 2026, Condition C	10	g
	MIL-STD-883F, Method 2007, Condition A	20	g
Moisture Sensitivity Level (MSL)		MSL1	

6.4 Recommended Operating Conditions

over operating free-air temperature range (unless otherwise noted)

		MIN	NOM	MAX	UNIT
VDD	Device Supply Voltage ⁽¹⁾	1.7	1.8	1.9	V
	Device Supply Voltage ⁽²⁾	2.37	2.5, 3.3	3.5	V
T _A	Ambient temperature ⁽³⁾	-40		85	°C
	Ambient temperature ⁽⁴⁾	-40		105	°C
T _J	Junction temperature			125	°C
t _{RAMP}	VDD power-up ramp time ^{(1) (2)}	0.1		100	ms

(1) For all devices with Recommended Operating Voltage of 1.8V ± 5%

(2) For all devices with Recommended Operating Voltage of 2.5V ± 5% and 3.3V ± 5%

(3) For all differential outputs - LMK6D, LMK6H and LMK6P.

(4) For single-ended output - LMK6C.

6.5 Thermal Information

THERMAL METRIC ⁽¹⁾		LMK6D/H/P		UNIT
		DLE (VSON)	DLF (VSON)	
		6 PINS	6 PINS	
$R_{\theta JA}$	Junction-to-ambient thermal resistance	101.2	107.9	°C/W
$R_{\theta JC(top)}$	Junction-to-case (top) thermal resistance	58.6	70.1	°C/W
$R_{\theta JB}$	Junction-to-board thermal resistance	31.3	39.4	°C/W
Ψ_{JT}	Junction-to-top characterization parameter	2.7	2.3	°C/W
Ψ_{JB}	Junction-to-board characterization parameter	31.1	39.2	°C/W

(1) For more information about traditional and new thermal metrics, see the [Semiconductor and IC Package Thermal Metrics](#) application note.

6.6 Thermal Information

THERMAL METRIC ⁽¹⁾		LMK6C		UNIT
		DLE (VSON)	DLF (VSON)	
		4 PINS	4 PINS	
$R_{\theta JA}$	Junction-to-ambient thermal resistance	124.8	128.1	°C/W
$R_{\theta JC(top)}$	Junction-to-case (top) thermal resistance	61.2	73.2	°C/W
$R_{\theta JB}$	Junction-to-board thermal resistance	42.5	39.8	°C/W
Ψ_{JT}	Junction-to-top characterization parameter	2.8	2.4	°C/W
Ψ_{JB}	Junction-to-board characterization parameter	42.3	39.5	°C/W

(1) For more information about traditional and new thermal metrics, see the [Semiconductor and IC Package Thermal Metrics](#) application note.

6.7 Electrical Characteristics

over Recommended Operating Conditions, Typical Temp = 25°C, Frequency output = 156.25MHz, VDD = 3.3V, LVCMOS Output Capacitor load = 2.2pF (unless otherwise specified)⁽⁴⁾

PARAMETER		TEST CONDITIONS	MIN	TYP	MAX	UNIT
Current Consumption Characteristics						
I _{DD}	Device Power Consumption (LVPECL, VDD = 2.5V or 3.3V, Excluding load current)	100MHz		65	82	mA
		156.25MHz		69	87	mA
		200MHz		67	85	mA
		312.5MHz		76	95	mA
		400MHz		88	108	mA
	Device Power Consumption (LVPECL, VDD = 1.8V, Excluding load current)	100MHz		61	79	mA
		156.25MHz		66	83	mA
		200MHz		64	82	mA
		312.5MHz		73	91	mA
		400MHz		84	104	mA
	Device Power Consumption (HCSL, VDD = 2.5V or 3.3V, Excluding load current)	100MHz		65	82	mA
		156.25MHz		69	87	mA
		200MHz		67	86	mA
		312.5MHz		76	96	mA
		400MHz		88	108	mA
	Device Power Consumption (HCSL, VDD = 1.8V, Excluding load current)	100MHz		58	75	mA
		156.25MHz		62	80	mA
		200MHz		60	78	mA
		312.5MHz		69	88	mA
		400MHz		77	97	mA
	Device Power Consumption (LVDS, VDD = 2.5V or 3.3V, Excluding load current)	100MHz		54	71	mA
		156.25MHz		58	75	mA
		200MHz		56	74	mA
		312.5MHz		65	84	mA
		400MHz		76	96	mA
	Device Power Consumption (LVDS, VDD = 1.8V, Excluding load current)	100MHz		52	68	mA
		156.25MHz		56	72	mA
		200MHz		54	71	mA
		312.5MHz		63	80	mA
		400MHz		74	92	mA
	Device Power Consumption (LVCMOS, VDD = 2.5V or 3.3V, with load)	100MHz		45	62	mA
		156.25MHz		55	71	mA
200MHz			61	77	mA	
Device Power Consumption (LVCMOS, VDD = 1.8V, with load)	100MHz		44	59	mA	
	156.25MHz		50	65	mA	
	200MHz		56	72	mA	
I _{DD-STBY}	Device Stand By current	ST (Stand By) = GND		6	13	mA
I _{DD-PD}	Device current with output disabled (100MHz)	OE = GND, LVPECL mode, VDD = 3.3V		48	67	mA
		OE = GND, HCSL mode, VDD = 3.3V		49	67	mA
		OE = GND, LVDS mode, VDD = 3.3V		49	66	mA
		OE = GND, LVCMOS mode, VDD = 3.3V		40	56	mA
LVPECL Output Characteristics						

over Recommended Operating Conditions, Typical Temp = 25°C, Frequency output = 156.25MHz, VDD = 3.3V, LVCMOS Output Capacitor load = 2.2pF (unless otherwise specified)⁽⁴⁾

PARAMETER		TEST CONDITIONS	MIN	TYP	MAX	UNIT
F _{out}	Output Frequency		1		400	MHz
V _{OD}	Output Voltage Swing (V _{OH} - V _{OL})	AC coupled, VDD = 3.3V	525	645	765	mV
		AC coupled, VDD = 2.5V	450	555	660	mV
		AC coupled, VDD = 1.8V	280	375	470	mV
		DC coupled, VDD = 2.5V or 3.3V ⁽¹⁾	650	800	950	mV
		DC coupled, VDD = 1.8V ⁽¹⁾	450	600	750	mV
V _{OD,DIFF}	Differential Output peak-peak swing		2× V _{OD}			V _{pp}
V _{OS}	Output Common-Mode Voltage	VDD = 3.3V ⁽¹⁾	1.5	1.6	1.7	V
		VDD = 2.5V ⁽¹⁾	0.825	0.9	0.975	V
		VDD = 1.8V ⁽¹⁾	0.45	0.5	0.55	V
t _R /t _F	Output Rise/Fall Time	20% to 80% of V _{OD,DIFF} , VDD = 2.5V or 3.3V		120	200	ps
		20% to 80% of V _{OD,DIFF} , VDD = 1.8V		120	200	ps
ODC	Output Duty Cycle	VDD = 2.5V or 3.3V, measured between 50% points on the waveform	45	50	55	%
		VDD = 1.8V, measured between 50% points on the waveform	45	50	55	%
LVDS Output Characteristics						
F _{out}	Output Frequency		1		400	MHz
V _{OD}	Output Voltage Swing (V _{OH} - V _{OL})	Under LVDS Load condition	250	350	450	mV
V _{OD,DIFF}	Differential Output peak-peak swing		2× V _{OD}			V _{pp}
V _{OS}	Output Common Mode Voltage	VDD = 2.5V or 3.3V	1.025	1.2	1.375	V
		VDD = 1.8V	0.80	0.9	1.0	V
t _R /t _F	Output Rise/Fall Time	20% to 80% of V _{OD,DIFF} , VDD = 2.5V or 3.3V		150	250	ps
		20% to 80% of V _{OD,DIFF} , VDD = 1.8V		150	250	ps
ODC	Output Duty Cycle	VDD = 2.5V or 3.3V, measured between 50% points on the waveform	45	50	55	%
		VDD = 1.8V, measured between 50% points on the waveform	45	50	55	%
HCSL Output characteristics						
F _{out}	Output Frequency		1		400	MHz
V _{OH}	Output High Voltage	DC coupled, 50Ω to ground, VDD = 2.5V or 3.3V	650	750	850	mV
		DC coupled, 50Ω to ground, VDD = 1.8V	460	560	660	mV
V _{OL}	Output Low Voltage	DC coupled, 50Ω to ground, VDD = 2.5V or 3.3V	-150	0	150	mV
		DC coupled, 50Ω to ground, VDD = 1.8V	-150	0	150	mV
V _{OD,DIFF}	Differential Output peak-peak swing		2× V _{OH} - V _{OL}			V
V _{cross}	Absolute Crossing Point Voltage	VDD = 3.3V or 2.5V, f _{out} = 100MHz	0.2	0.35	0.50	V _{pp}
		VDD = 1.8V, f _{out} = 100MHz	0.15	0.275	0.40	V _{pp}
V _{cross-delta}	Absolute Crossing Point Voltage variation	VDD = 3.3V or 2.5V or 1.8V, f _{out} = 100MHz		0.14		V
dV/dt	Output Slew Rate	50Ω to ground; DC coupled load; measured slew rate in ±150mV from Center.	2		12	V/ns
ΔdV/dt	Output Slew Rate variation				20	%

over Recommended Operating Conditions, Typical Temp = 25°C, Frequency output = 156.25MHz, VDD = 3.3V, LVCMOS Output Capacitor load = 2.2pF (unless otherwise specified)⁽⁴⁾

PARAMETER		TEST CONDITIONS	MIN	TYP	MAX	UNIT
ODC	Output Duty Cycle		45	50	55	%
LVCMOS Output Characteristics						
F _{out}	Output Frequency		1		200	MHz
V _{OL}	Output Low Voltage	I _{OL} = 3.6mA, VDD = 1.8V			0.36	V
		I _{OL} = 5.0mA, VDD = 2.5V			0.5	V
		I _{OL} = 6.6mA, VDD = 3.3V			0.66	V
V _{OH}	Output High Voltage	I _{OH} = 3.6mA, VDD = 1.8V	1.44			V
		I _{OH} = 5.0mA, VDD = 2.5V	2			V
		I _{OH} = 6.6mA, VDD = 3.3V	2.64			V
t _R /t _F	Output Rise/Fall Time	20% to 80% of V _{OH} -V _{OL} , C _L = 2pF		0.5	1	ns
ODC	Output Duty Cycle		45	50	55	%
R _{out}	Output Impedance	OE = HIGH	40	50	60	Ω
C _L	Maximum capacitive load	F _{out} > 50MHz ⁽³⁾			15	pF
		F _{out} < 50MHz ⁽³⁾			30	pF
Function Pin Input Characteristics (OE/ST pin)						
V _{IL}	Input Low Voltage				0.6	V
V _{IH}	Input High Voltage		1.3			V
I _{IL}	Input Low Current	OE = GND	-40			μA
I _{IH}	Input High Current	OE = VDD			40	μA
C _{IN}	Input Capacitance			2		pF
LVDS, HCSL and LVPECL Frequency Tolerance						
F _T	Total Frequency Stability	Inclusive of: solder shift, initial tolerance, variation over -40 °C to 85°C, variation over rated supply voltage range, and 10 year aging at 25°C.	-25		25	ppm
		Inclusive of: solder shift, initial tolerance, variation over -40°C to 85°C, variation over supply voltage range.	-20		20	ppm
LVCMOS Frequency Tolerance						
F _T	Total Frequency Stability	Inclusive of: solder shift, initial tolerance, variation over -40°C to 105°C, variation over rated supply voltage range, and 10 year aging at 25 °C.	-25		25	ppm
		Inclusive of: solder shift, initial tolerance, variation over -40°C to 105°C, variation over rated supply voltage range.	-20		20	ppm
Differential output PSRR Characteristics						
PSRR	Spur induced by 50mV power supply ripple at 156.25MHz output, VDD = 2.5V or 3.3V, No power supply decoupling capacitor	Sine wave at 50kHz		-71		dBc
		Sine wave at 100kHz		-71		dBc
		Sine wave at 500kHz		-72		dBc
		Sine wave at 1MHz		-70		dBc
PSRR	Spur induced by 50mV power supply ripple at 156.25MHz output, VDD = 1.8V, No power supply decoupling capacitor	Sine wave at 50kHz		-64		dBc
		Sine wave at 100kHz		-64		dBc
		Sine wave at 500kHz		-67		dBc
		Sine wave at 1MHz		-68		dBc
PSRR	Jitter sensitivity to Power supply ripple;	100kHz sine wave ripple, 3.3V Supply ⁽²⁾		4		fs/mV
LVCMOS PSRR Characteristics						

over Recommended Operating Conditions, Typical Temp = 25°C, Frequency output = 156.25MHz, VDD = 3.3V, LVCMOS Output Capacitor load = 2.2pF (unless otherwise specified)⁽⁴⁾

PARAMETER		TEST CONDITIONS	MIN	TYP	MAX	UNIT
PSRR	Spur induced by 50mV power supply ripple at 50MHz output, VDD = 2.5V or 3.3V, No power supply decoupling capacitor	Sine wave at 50kHz		-72		dBc
		Sine wave at 100kHz		-71		dBc
		Sine wave at 500kHz		-70		dBc
		Sine wave at 1MHz		-69		dBc
PSRR	Spur induced by 50mV power supply ripple at 50MHz output, VDD = 1.8V, No power supply decoupling capacitor	Sine wave at 50kHz		-50		dBc
		Sine wave at 100kHz		-50		dBc
		Sine wave at 500kHz		-52		dBc
		Sine wave at 1MHz		-55		dBc
PSRR	Jitter sensitivity to Power supply ripple;	100kHz sine wave ripple, 3.3V Supply ⁽²⁾		10		fs/mV
Power-On Characteristics						
t _{START_UP}	Start-up Time	Time elapsed from 0.95 x VDD until output is enabled and output is within specification; Tested with a VDD supply ramp time of approximately 200µs			5	ms
t _{OE-EN}	Output Enable Time	Time elapsed from OE = V _{IH} until output is enabled and output is within specification, F _{out} > 10MHz			25	µs
t _{OE-DIS}	Output Disable Time	Time elapsed from OE = V _{IL} until output is disabled, F _{out} > 10MHz			1	µs
LVPECL - Clock Output Jitter						
PN _{1k}	Phase Noise at 1kHz Offset	F _{out} = 156.25MHz.		-95		dBc/Hz
PN _{10k}	Phase Noise at 10kHz Offset			-127		dBc/Hz
PN _{100k}	Phase Noise at 100kHz Offset			-146		dBc/Hz
PN _{1M}	Phase Noise at 1MHz Offset			-156		dBc/Hz
PN _{10M}	Phase Noise at 10MHz Offset			-158		dBc/Hz
PN _{1k}	Phase Noise at 1kHz Offset	F _{out} = 312.5MHz.		-89		dBc/Hz
PN _{10k}	Phase Noise at 10kHz Offset			-121		dBc/Hz
PN _{100k}	Phase Noise at 100kHz Offset			-140		dBc/Hz
PN _{1M}	Phase Noise at 1MHz Offset			-150		dBc/Hz
PN _{10M}	Phase Noise at 10MHz Offset			-154		dBc/Hz
R _J	RMS Jitter (Integration BW: 12kHz to 20MHz)	F _{out} = 100MHz		125	170	fs
		F _{out} = 125MHz		100	125	fs
		F _{out} = 155.52MHz		100	125	fs
		F _{out} = 156.25MHz		100	125	fs
		F _{out} = 161.1328125MHz		110	150	fs
		F _{out} = 200MHz		120	150	fs
		F _{out} = 312.5MHz		100	125	fs
F _{out} = 400MHz		100	135	fs		
R _{PeriodJITT,RMS}	RMS Period Jitter	F _{out} ≥ 25MHz		1.7		ps
R _{JITT,PK-PK}	Peak-peak Period Jitter	F _{out} ≥ 25MHz		13		ps
LVDS - Clock Output Jitter						

over Recommended Operating Conditions, Typical Temp = 25°C, Frequency output = 156.25MHz, VDD = 3.3V, LVCMOS
Output Capacitor load = 2.2pF (unless otherwise specified)⁽⁴⁾

PARAMETER		TEST CONDITIONS	MIN	TYP	MAX	UNIT
PN _{1k}	Phase Noise at 1kHz Offset	F _{out} = 156.25MHz		-95		dBc/Hz
PN _{10k}	Phase Noise at 10kHz Offset			-128		dBc/Hz
PN _{100k}	Phase Noise at 100kHz Offset			-146		dBc/Hz
PN _{1M}	Phase Noise at 1MHz Offset			-156		dBc/Hz
PN _{10M}	Phase Noise at 10MHz Offset			-156.5		dBc/Hz
PN _{1k}	Phase Noise at 1kHz Offset	F _{out} = 312.5MHz.		-89		dBc/Hz
PN _{10k}	Phase Noise at 10kHz Offset			-122		dBc/Hz
PN _{100k}	Phase Noise at 100kHz Offset			-139		dBc/Hz
PN _{1M}	Phase Noise at 1MHz Offset			-150		dBc/Hz
PN _{10M}	Phase Noise at 10MHz Offset			-153.5		dBc/Hz
R _J	RMS Jitter (Integration BW: 12kHz to 20MHz)	F _{out} = 100MHz		140	170	fs
		F _{out} = 125MHz		110	125	fs
		F _{out} = 155.52MHz		105	140	fs
		F _{out} = 156.25MHz		100	125	fs
		F _{out} = 161.1328125MHz		125	160	fs
		F _{out} = 200MHz		125	150	fs
		F _{out} = 312.5MHz		100	125	fs
F _{out} = 400MHz		100	135	fs		
R _{PeriodJITT} ,RMS	RMS Period Jitter	F _{out} ≥ 25MHz		1.6		ps
R _{JITT,PK-PK}	Peak-peak Period Jitter	F _{out} ≥ 25MHz		13		ps
HCSL - Clock output jitter						

over Recommended Operating Conditions, Typical Temp = 25°C, Frequency output = 156.25MHz, VDD = 3.3V, LVCMOS Output Capacitor load = 2.2pF (unless otherwise specified)⁽⁴⁾

PARAMETER		TEST CONDITIONS	MIN	TYP	MAX	UNIT
J _{PCle1-cc}	PCIe Gen 1 Common Clock jitter (jitter limit = 86ps)	F _{out} = 100MHz	0.146		6.4	ps
J _{PCle1-SRNS}	PCIe Gen 1 SRNS jitter		0.447		6.99	ps
J _{PCle2-cc}	PCIe Gen 2 Common Clock jitter (jitter limit = 3ps)		0.103		0.554	ps
J _{PCle2-SRNS}	PCIe Gen 2 SRNS jitter		0.135		0.56	ps
J _{PCle3-cc}	PCIe Gen 3 Common Clock jitter (jitter limit = 1ps)		0.029		0.164	ps
J _{PCle3-SRNS}	PCIe Gen 3 SRNS jitter		0.033		0.180	ps
J _{PCle4-cc}	PCIe Gen 4 Common Clock jitter (jitter limit = 500fs)		0.029		0.164	ps
J _{PCle4-SRNS}	PCIe Gen 4 SRNS jitter		0.033		0.180	ps
J _{PCle5-cc}	PCIe Gen 5 Common Clock jitter (jitter limit = 150fs)		0.007		0.070	ps
J _{PCle5-SRNS}	PCIe Gen 5 SRNS jitter		0.007		0.074	ps
J _{PCle6-cc}	PCIe Gen 6 Common Clock jitter (jitter limit = 100fs)		0.007		0.042	ps
J _{PCle6-SRNS}	PCIe Gen 6 SRNS jitter		0.009		0.052	ps
J _{PCle7-cc}	PCIe Gen 7 Common Clock jitter (jitter limit = 67fs)		0.005		0.028	ps
J _{PCle7-SRNS}	PCIe Gen 7 SRNS jitter		0.006		0.034	ps
PN _{1k}	Phase Noise at 1kHz Offset	F _{out} = 156.25MHz.		-95		dBc/Hz
PN _{10k}	Phase Noise at 10kHz Offset			-127		dBc/Hz
PN _{100k}	Phase Noise at 100kHz Offset			-146		dBc/Hz
PN _{1M}	Phase Noise at 1MHz Offset			-156		dBc/Hz
PN _{10M}	Phase Noise at 10MHz Offset			-158		dBc/Hz
PN _{1k}	Phase Noise at 1kHz Offset	F _{out} = 312.5MHz.		-89		dBc/Hz
PN _{10k}	Phase Noise at 10kHz Offset			-121		dBc/Hz
PN _{100k}	Phase Noise at 100kHz Offset			-140		dBc/Hz
PN _{1M}	Phase Noise at 1MHz Offset			-150		dBc/Hz
PN _{10M}	Phase Noise at 10MHz Offset			-154		dBc/Hz
R _J	RMS Jitter (Integration BW: 12kHz to 20MHz)	F _{out} = 100MHz		125	170	fs
		F _{out} = 125MHz		100	125	fs
		F _{out} = 155.52MHz		100	125	fs
		F _{out} = 156.25MHz		100	125	fs
		F _{out} = 161.1328125MHz		110	150	fs
		F _{out} = 200MHz		120	150	fs
		F _{out} = 312.5MHz		100	125	fs
F _{out} = 400MHz		100	135	fs		
R _{PeriodJITT} ,RMS	RMS Period Jitter	F _{out} ≥ 25MHz		1.7		ps

over Recommended Operating Conditions, Typical Temp = 25°C, Frequency output = 156.25MHz, VDD = 3.3V, LVCMOS Output Capacitor load = 2.2pF (unless otherwise specified)⁽⁴⁾

PARAMETER		TEST CONDITIONS	MIN	TYP	MAX	UNIT
RJITT,PK-PK	Peak-peak Period Jitter	$F_{out} \geq 25\text{MHz}$		13		ps
LVCMOS - Clock Output Jitter						
PN _{1k}	Phase Noise at 1kHz Offset	$F_{out} = 156.25\text{MHz}$		-100		dBc/Hz
PN _{10k}	Phase Noise at 10kHz Offset			-128		dBc/Hz
PN _{100k}	Phase Noise at 100kHz Offset			-143		dBc/Hz
PN _{1M}	Phase Noise at 1MHz Offset			-150		dBc/Hz
PN _{10M}	Phase Noise at 10MHz Offset			-152		dBc/Hz
R _J	RMS Jitter (Integration BW: 12kHz to 5MHz)	$F_{out} = 24\text{MHz}$		0.25	0.5	ps
		$F_{out} = 25\text{MHz}$		0.25	0.5	ps
		$F_{out} = 33.33\text{MHz}$		0.25	1	ps
	RMS Jitter (Integration BW: 12kHz to 20MHz)	$F_{out} = 40\text{MHz}$		0.5	1	ps
		$F_{out} = 50\text{MHz}$		0.4	1	ps
		$F_{out} = 66.66\text{MHz}$		0.5	1	ps
		$F_{out} = 74.25\text{MHz}$		0.3	0.5	ps
		$F_{out} = 78\text{MHz}$		0.35	0.5	ps
		$F_{out} = 100\text{MHz}$		0.35	0.5	ps
		$F_{out} = 125\text{MHz}$		0.35	0.5	ps
	$F_{out} = 156.25\text{MHz}$		0.25	0.5	ps	
RPeriodJITT _{,RMS}	RMS Period Jitter	$F_{out} \geq 25\text{MHz}$		1.5		ps
RJITT,PK-PK	Peak-peak Period Jitter	$F_{out} \geq 25\text{MHz}$		13		ps

- (1) DC Load condition
- (2) Measured using TI LMK6x Evaluation Module;
- (3) Refer to *Application Curves* section for Rise time and fall time details for different capacitor load values.
- (4) The Jitter specifications are based on design and characterisation

6.8 Timing Diagrams

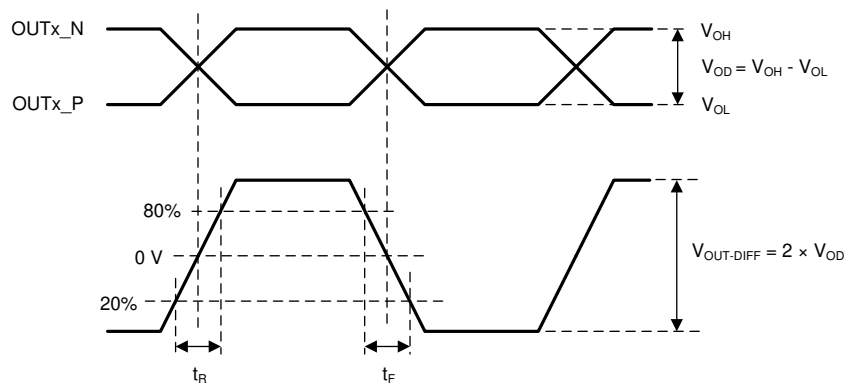

Figure 6-1. Differential Output Voltage and Rise/Fall Time

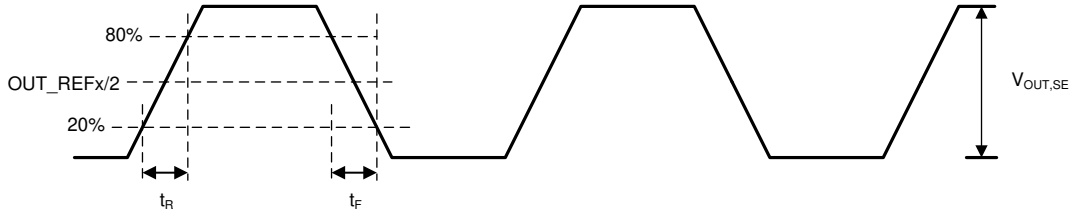

Figure 6-2. Single-Ended Output Voltage and Rise/Fall Time

6.9 Typical Characteristics

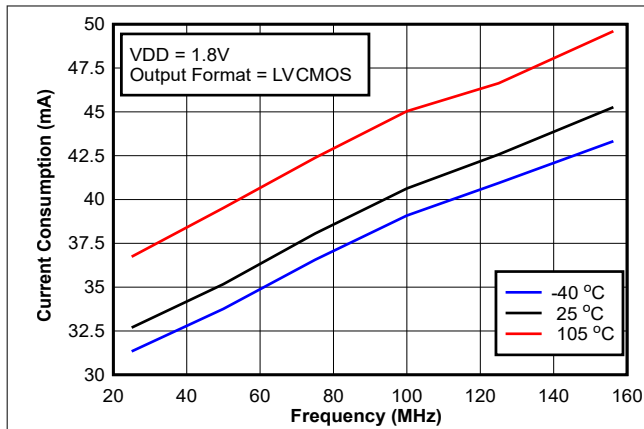

Figure 6-3. Current Consumption vs Frequency (LVCMOS, 1.8V)

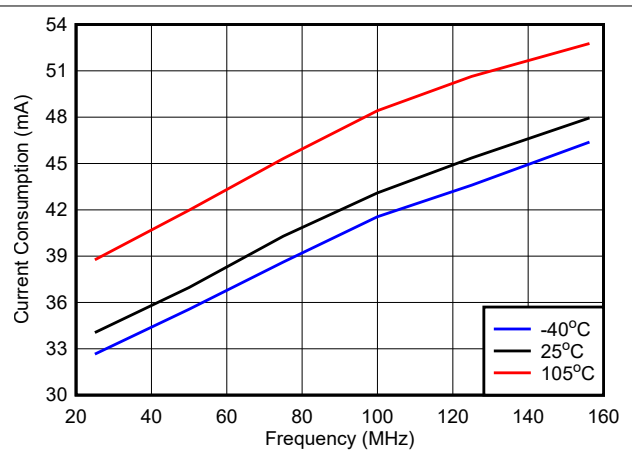

Figure 6-4. Current Consumption vs Frequency (LVCMOS, 2.5V)

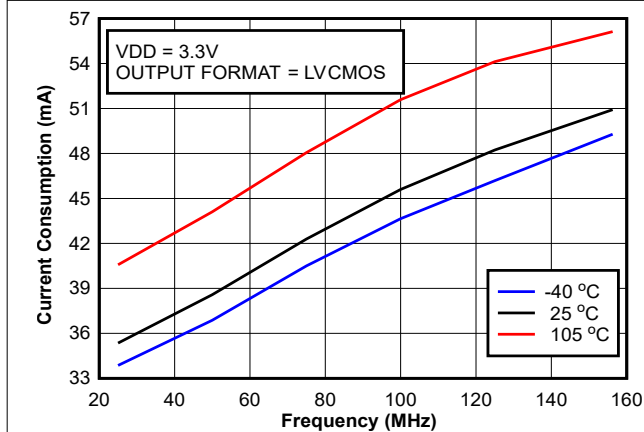

Figure 6-5. Current Consumption vs Frequency (LVCMOS, 3.3V)

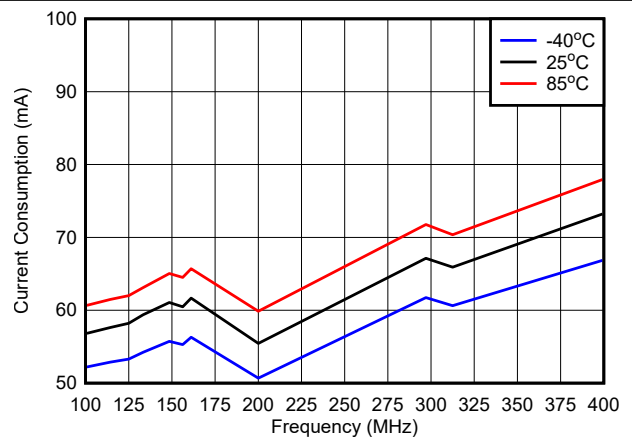

Figure 6-6. Current Consumption vs Frequency (HCSL, 1.8V)

6.9 Typical Characteristics (continued)

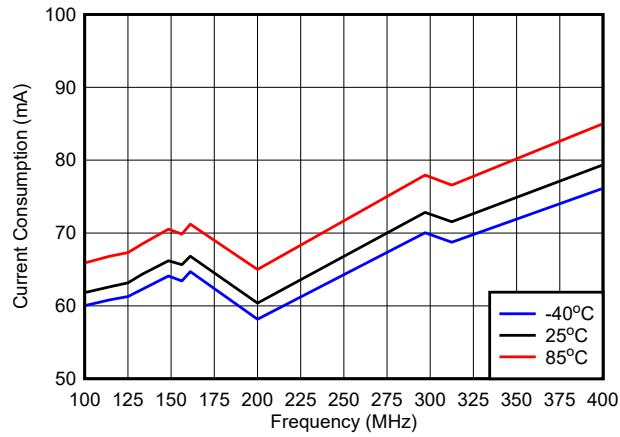

Figure 6-7. Current Consumption vs Frequency (HCSL, 2.5V)

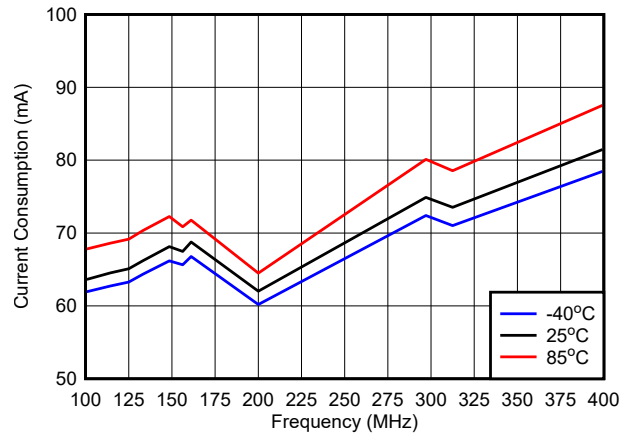

Figure 6-8. Current Consumption vs Frequency (HCSL, 3.3V)

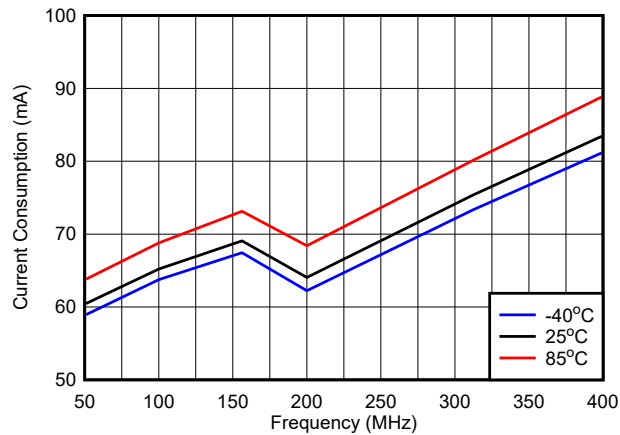

Figure 6-9. Current Consumption vs Frequency (LVPECL, 1.8V)

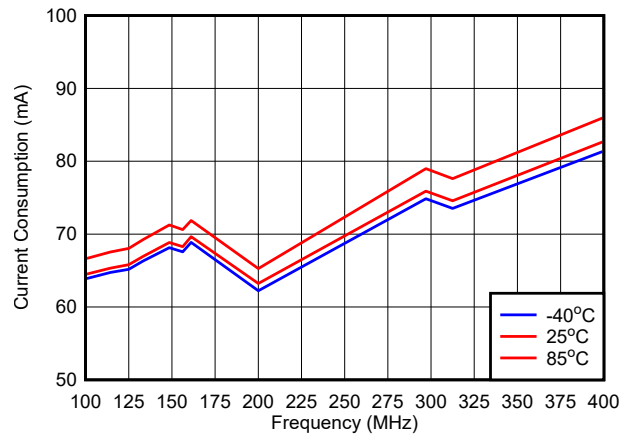

Figure 6-10. Current Consumption vs Frequency (LVPECL, 2.5V)

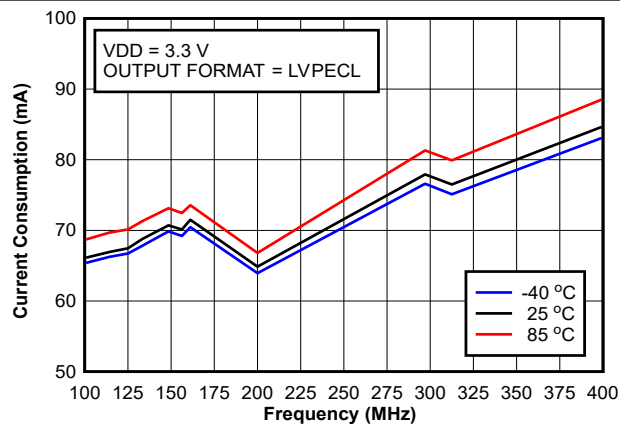

Figure 6-11. Current Consumption vs Frequency (LVPECL, 3.3V)

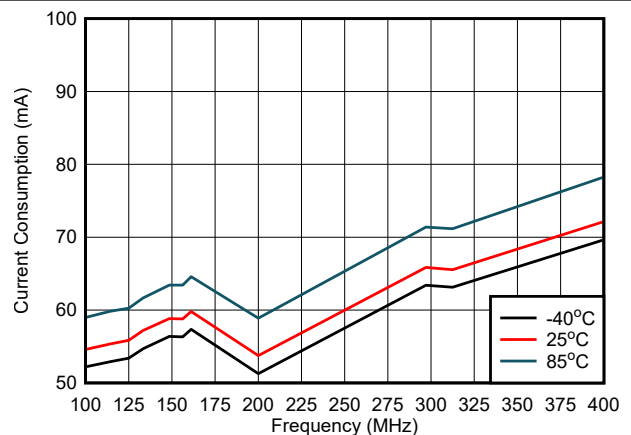

Figure 6-12. Current Consumption vs Frequency (LVDS, 1.8V)

6.9 Typical Characteristics (continued)

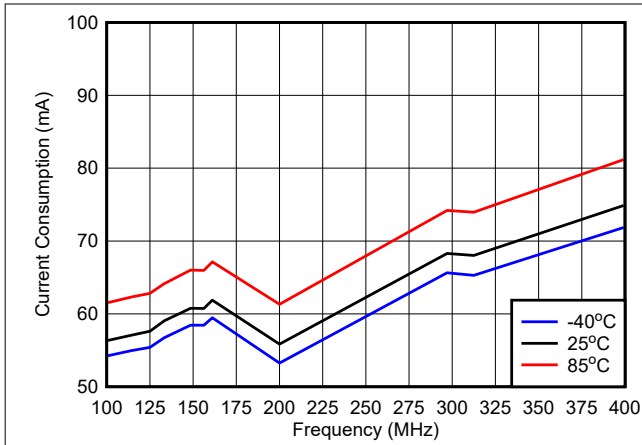

Figure 6-13. Current Consumption vs Frequency (LVDS, 2.5V)

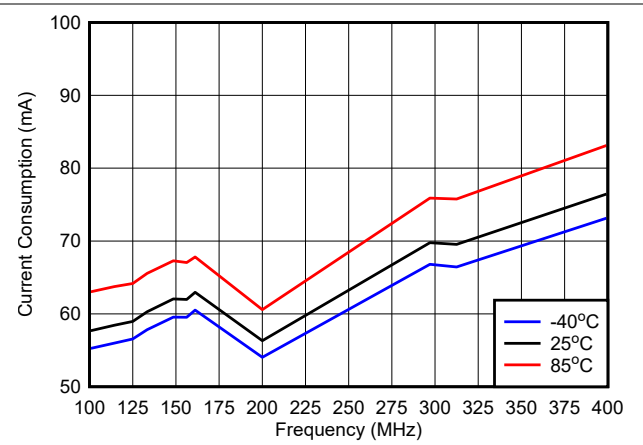

Figure 6-14. Current Consumption vs Frequency (LVDS, 3.3V)

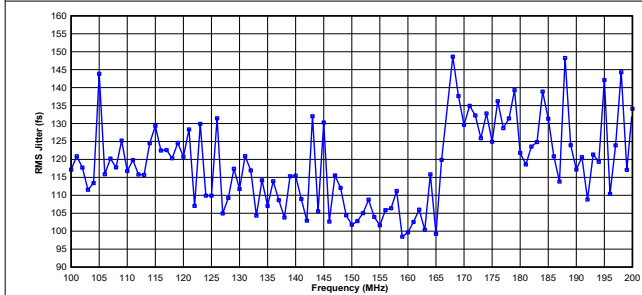

Figure 6-15. RMS Jitter vs Frequency (100MHz to 200MHz) for LVPECL, HCSL; TYPICAL 3.3V, 25°C

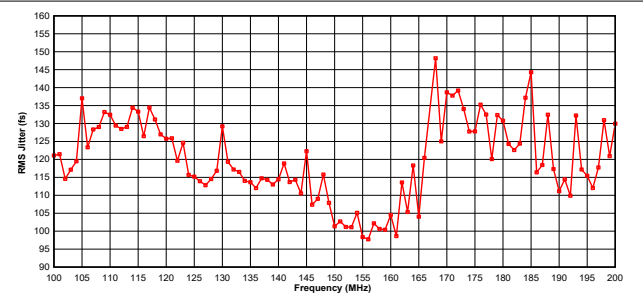

Figure 6-16. RMS Jitter vs Frequency (100MHz to 200MHz) for LVDS; TYPICAL 3.3V, 25°C

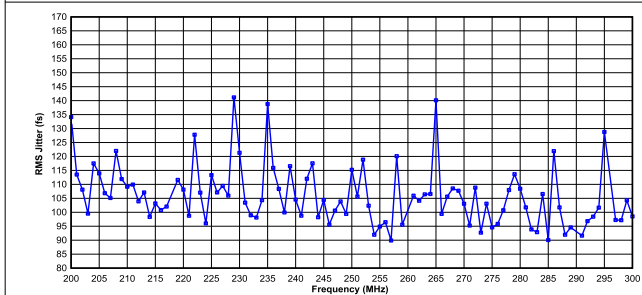

Figure 6-17. RMS Jitter vs Frequency (200MHz to 300MHz) for LVPECL, HCSL; TYPICAL 3.3V, 25°C

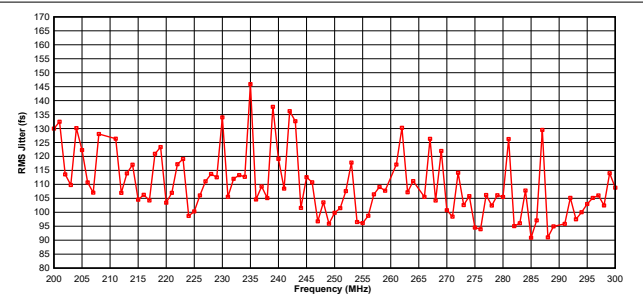

Figure 6-18. RMS Jitter vs Frequency (200MHz to 300MHz) for LVDS; TYPICAL 3.3V, 25°C

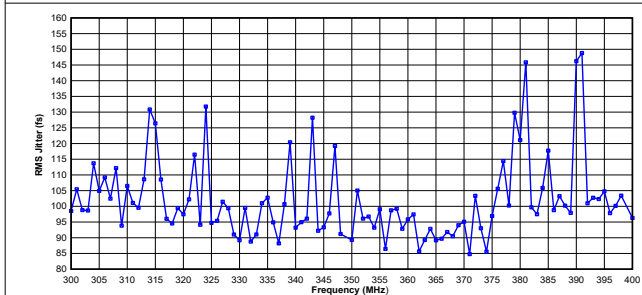

Figure 6-19. RMS Jitter vs Frequency (300MHz to 400MHz) for LVPECL, HCSL; TYPICAL 3.3V, 25°C

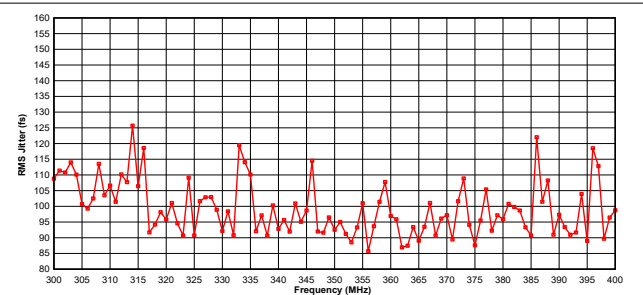

Figure 6-20. RMS Jitter vs Frequency (300MHz to 400MHz) for LVDS; TYPICAL 3.3V, 25°C

6.9 Typical Characteristics (continued)

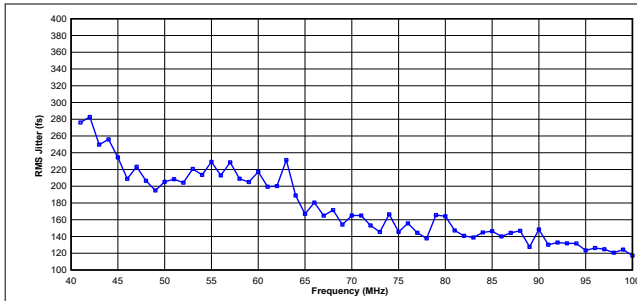

Figure 6-21. RMS Jitter vs Frequency (Below 100MHz) for LVPECL, HCSL; TYPICAL 3.3V, 25°C

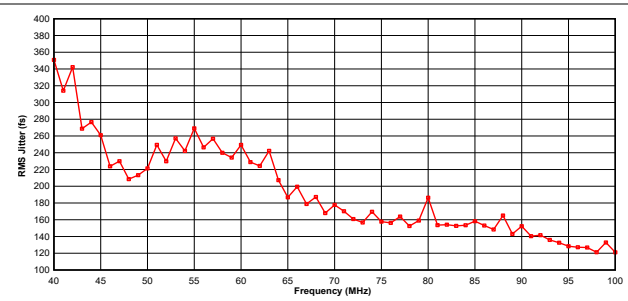

Figure 6-22. RMS Jitter vs Frequency (Below 100MHz) for LVDS; TYPICAL 3.3V, 25°C

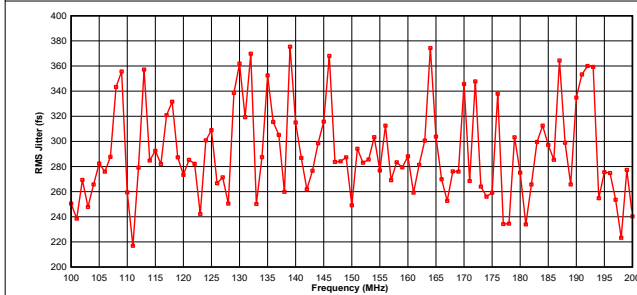

Figure 6-23. RMS Jitter vs Frequency (100MHz - 200MHz) for LVCMOS; TYPICAL 3.3V, 25°C

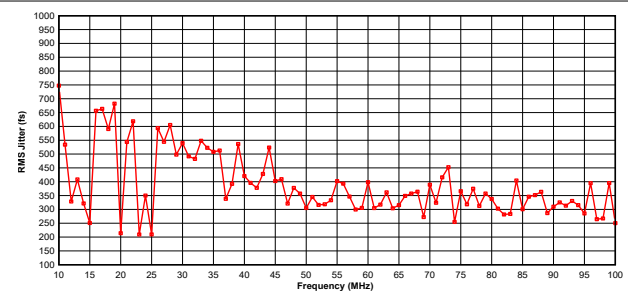

Figure 6-24. RMS Jitter vs Frequency (10MHz - 100MHz) for LVCMOS; TYPICAL 3.3V, 25°C

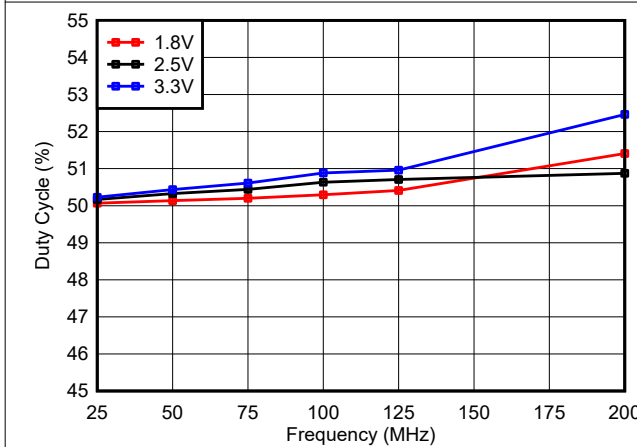

Figure 6-25. Duty Cycle (%) vs Frequency vs Power Supply; 25°C

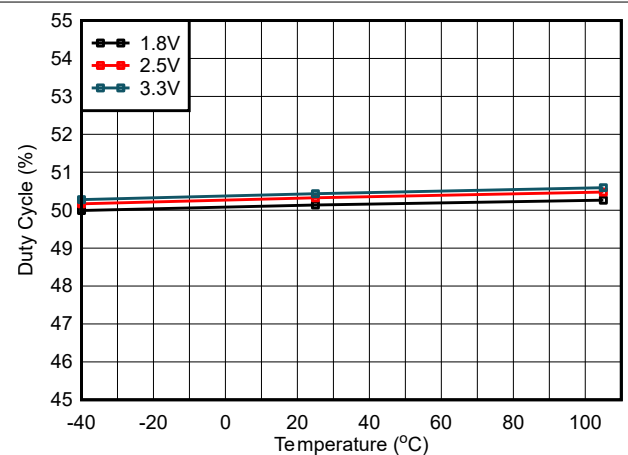

Figure 6-26. Duty Cycle (%) vs Temperature vs Power Supply; 50MHz Frequency

6.9 Typical Characteristics (continued)

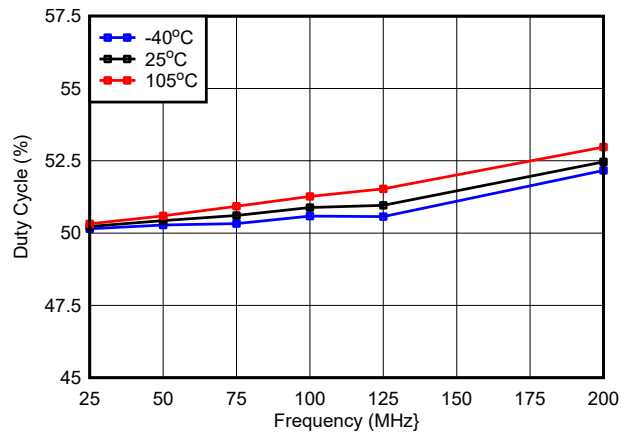

Figure 6-27. Duty Cycle (%) vs Frequency Over Temperature Range for LVC MOS; 3.3V

7 Parameter Measurement Information

7.1 Device Output Configurations

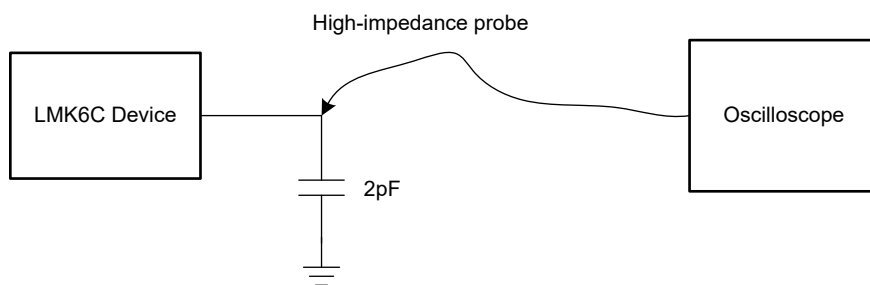

Figure 7-1. LMK6C Output Test Configuration

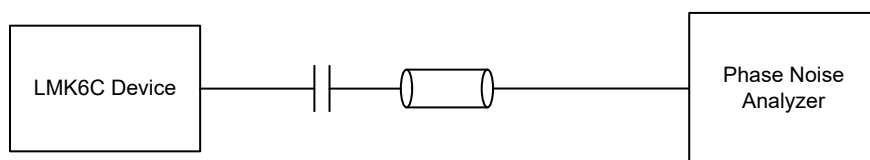

Figure 7-2. LMK6C Output Phase Noise Test Configuration

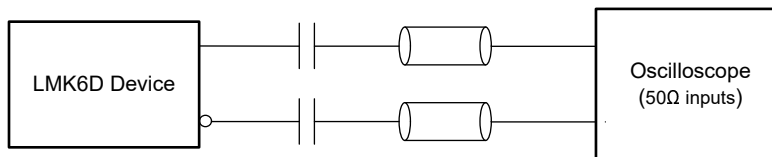

Figure 7-3. LMK6D Output Test Configuration

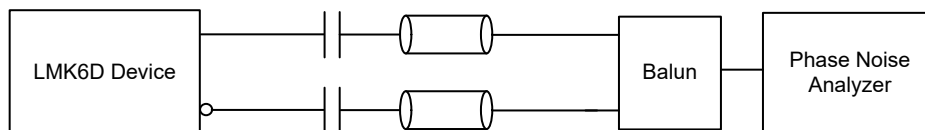

Figure 7-4. LMK6D Output Phase Noise Configuration

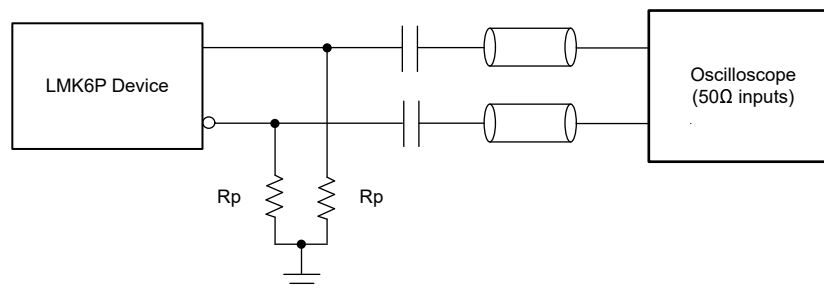

Figure 7-5. LMK6P Output Test Configuration

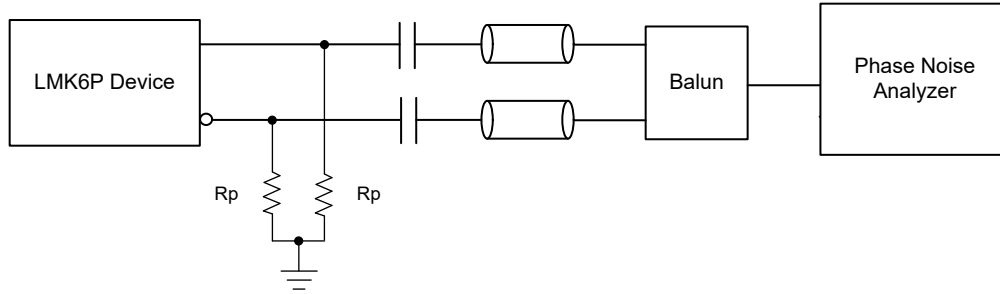

Figure 7-6. LMK6P Output Phase Noise Configuration

Table 7-1. LMK6P Output Test configuration and Phase Noise Configuration R_p Values

SUPPLY (V)	R_p (Ω)
3.3	207.5
2.5	112.5
1.8	83.3

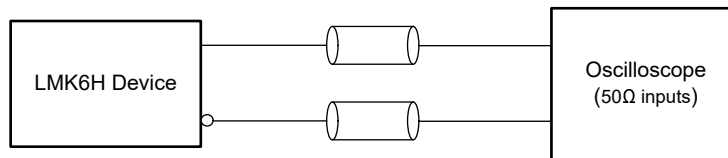

Figure 7-7. LMK6H Output Test Configuration

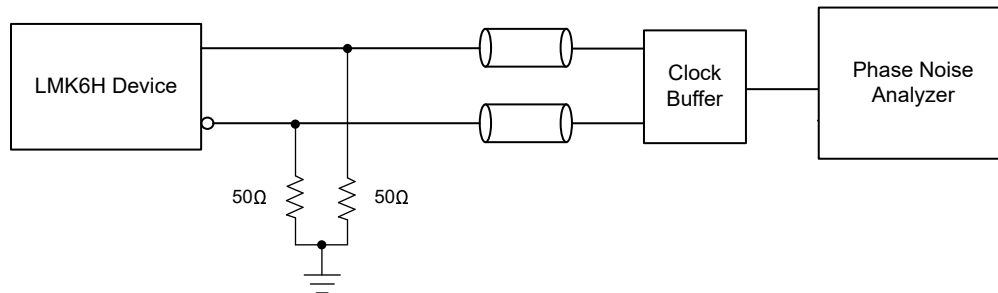

Figure 7-8. LMK6H Output Phase Noise Configuration

8 Detailed Description

8.1 Overview

The LMK6x is a fixed-frequency BAW based oscillator that can provide ultra-low jitter for both differential and single-ended output types.

8.2 Functional Block Diagram

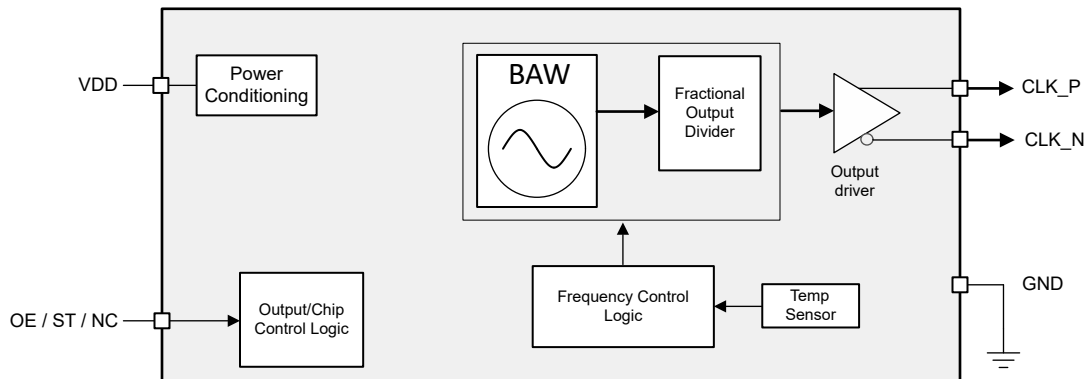

8.3 Feature Description

8.3.1 Bulk Acoustic Wave (BAW)

TI's BAW resonator technology uses piezoelectric transduction to generate high-Q resonance at 2.5GHz. The resonator is defined by the quadrilateral area overlaid by top and bottom electrodes. Alternating high- and low-acoustic impedance layers form acoustic mirrors beneath the resonant body to prevent acoustic energy leakage into the substrate. Furthermore, these acoustic mirrors are also placed on top of the resonator stack to protect the device from contamination and minimize energy leakage into the package materials. This unique dual-Bragg acoustic resonator (DBAR) allows efficient excitation without the need of costly vacuum cavities around the resonator. As a result, TI's BAW resonator is immune to frequency drift caused by adsorption of surface contaminants and can be directly placed in a non-hermetic plastic package with the oscillator IC in small standard oscillator footprints. Refer to [BAW](#) for more details on BAW technology.

8.3.2 Device Block-Level Description

The device contains a BAW oscillator, a Fractional Output Divider (FOD), and output driver, which together generates a pre-programmed output frequency. Temperature variations of oscillation frequency are continuously monitored by internal precision temperature sensor and provided as input to the frequency control logic block. Using this frequency control logic block, frequency corrections are performed internally for maintaining the output frequency within ± 25 ppm across temperature range and aging. The output driver is capable of providing both single-ended LVCMOS and differential LVPECL, LVDS, and HCSL output formats. The device contains an internal LDO which reduces the power supply noise, resulting in low noise clock output.

8.3.3 Function Pins

Pin 1 on the LMK6C and pin 1 or pin 2 on the LMK6P, LMK6D, and LMK6H are the function pins which have multiple functions based on the orderable part number. The function can be used as Output Enable (OE), Stand By (ST) or No Connect (NC). Options for both Active High and Active Low are available for OE and ST. Contact TI for Active Low options. [Table 8-1](#) lists the functions of pin 1 and pin 2 for differential output 6-pin packages and [Table 8-2](#) lists the functions of pin 1 for single-ended outputs.

Table 8-1. Function Pin Descriptions for 6-Pin Packages (LMK6D, LMK6H, LMK6P)

ORDERABLE OPTION	PIN DESCRIPTION	OUTPUT FUNCTION	OTHER FUNCTIONAL PIN CONFIGURATION
E (Pin 1)	Output Enable (Active High / NC)	HIGH or No Connect: Output active at Specified Frequency LOW: Output disabled, high impedance; current consumption is given by I_{DD-PD}	Pin 2 can be left floating or grounded
F (Pin 2)	Output Enable (Active High / NC)	HIGH or No Connect: Output active at Specified Frequency LOW: Output disabled, high impedance; current consumption is given by I_{DD-PD}	Pin 1 can be left floating or grounded
A (Pin 1)	Standby (Active Low)	LOW: High Impedance; standby mode; current consumption is given by standby current $I_{DD-STBY}$ HIGH or No Connect: Output active at Specified Frequency	Pin 2 can be left open or grounded
B (Pin 2)	Standby (Active Low)	LOW: High Impedance; standby mode; current consumption is given by standby current $I_{DD-STBY}$ HIGH or No Connect: Output active at Specified Frequency	Pin 1 can be left open or grounded

Table 8-2. Function Pin Descriptions for 4-Pin Packages (LMK6C)

ORDERABLE OPTION	PIN DESCRIPTION	OUTPUT FUNCTION
E (Pin 1)	Output Enable (Active High / NC)	HIGH or No Connect: Output active at Specified Frequency LOW: Output disabled, high impedance; current consumption is given by I_{DD-PD}
A (Pin 1)	Standby (Active Low)	LOW : High Impedance; standby mode; current consumption is given by standby current $I_{DD-STBY}$ HIGH or No Connect : Output active at Specified Frequency

In standby mode, all blocks are powered down to provide a maximum current consumption savings equivalent to the standby current provided in the *Current Consumption Characteristics* portion of the [Electrical Characteristics](#) table. The return to the output clock active time corresponds to same as the initial start-up time.

The Function Pin is driven internally with resistance greater than 100kΩ.

8.3.4 Clock Output Interfacing and Termination

These figures show the recommended output interfacing and termination circuits.

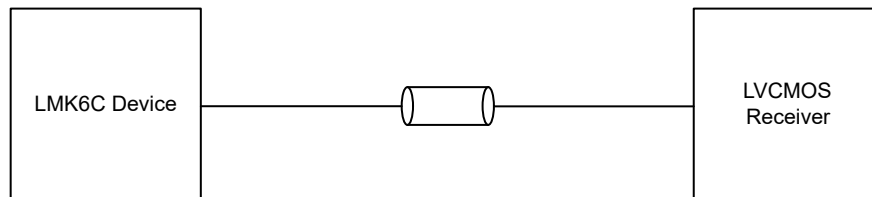

Figure 8-1. LMK6C Output to LVCMOS Receiver

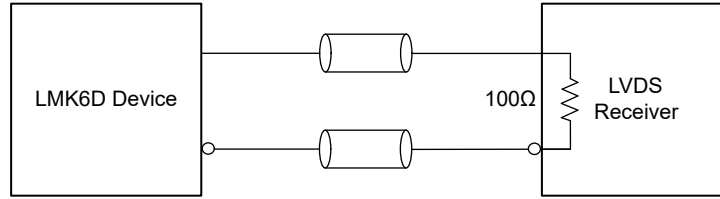

Figure 8-2. LMK6D Output DC-Coupled to LVDS Receiver With Internal Termination/Biasing

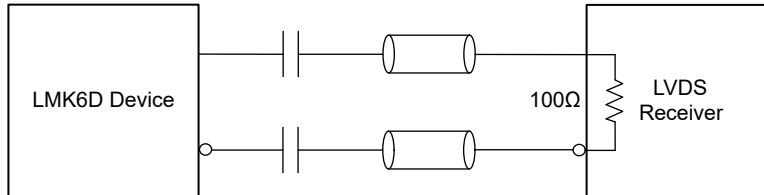

Figure 8-3. LMK6D Output AC Coupled to LVDS Receiver With Internal Termination/Biasing

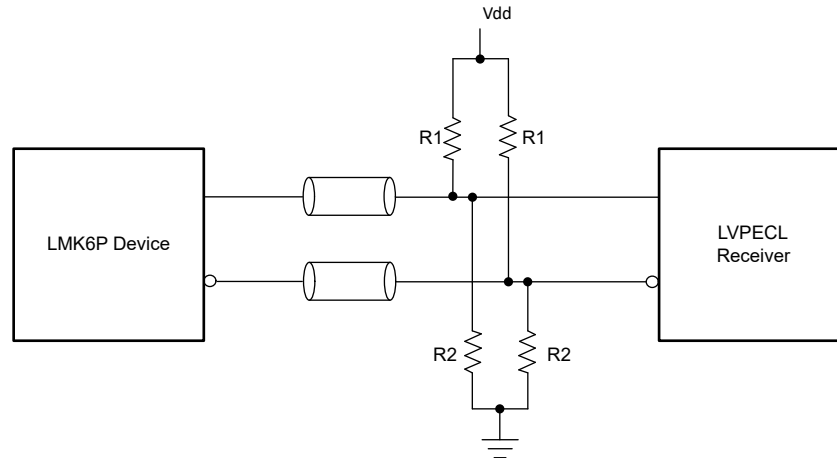

Figure 8-4. LMK6P Output DC-Coupled to LVPECL Receiver With External Termination/Biasing (T-Network)

Table 8-3. LMK6P T-Network DC-Coupled Resistor Values

SUPPLY (V)	R1 (Ω)	R2 (Ω)
3.3	133	82
2.5	250	62.5
1.8	450	56.5

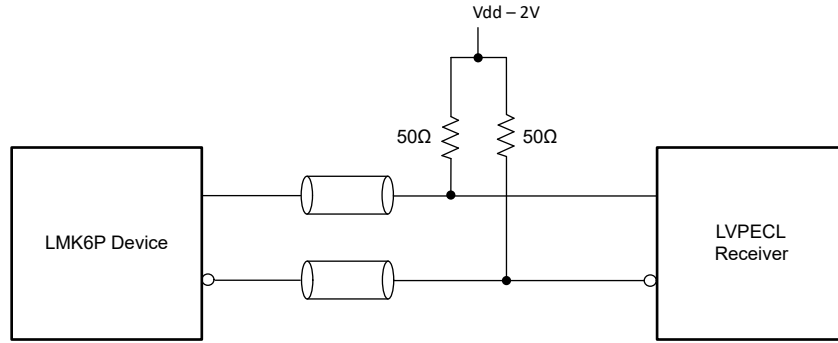

Figure 8-5. LMK6P Output DC-Coupled to LVPECL Receiver With External Termination/Biasing (50Ω to VDD - 2V)

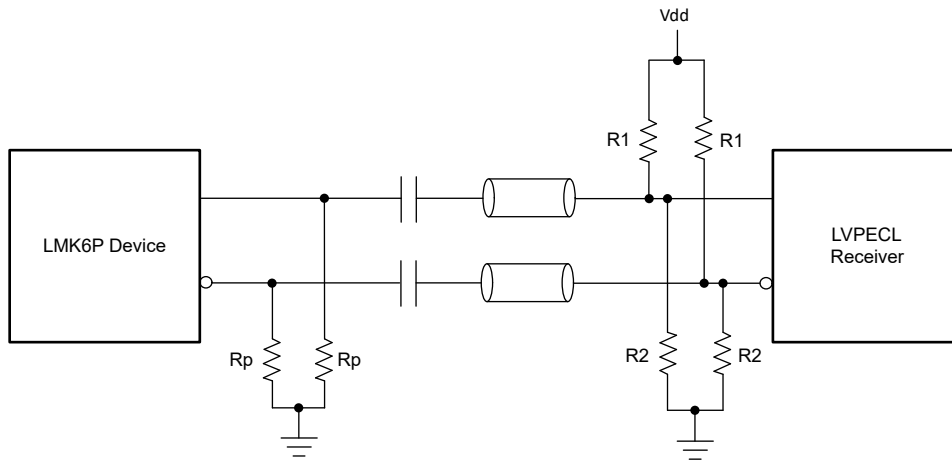

Figure 8-6. LMK6P Output AC-Coupled to LVPECL Receiver With External Termination/Biasing (T-Network)

Table 8-4. LMK6P T-Network AC-Coupled Resistor Values

SUPPLY (V)	R _p (Ω)	R ₁ (Ω)	R ₂ (Ω)
3.3	207.5	133	82
2.5	112.5	250	62.5
1.8	83.3	450	56.6

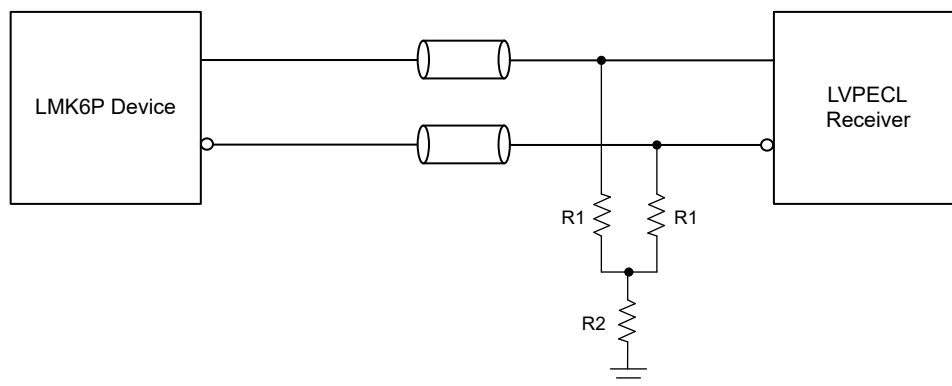

Figure 8-7. LMK6P Output DC-Coupled to LVPECL Receiver With External Termination/Biasing (Y-Network)

Table 8-5. LMK6P Y-Network DC-Coupled Resistor Values

SUPPLY (V)	R1 (Ω)	R2 (Ω)
3.3	50	78.8
2.5	50	31.3
1.8	50	16.7

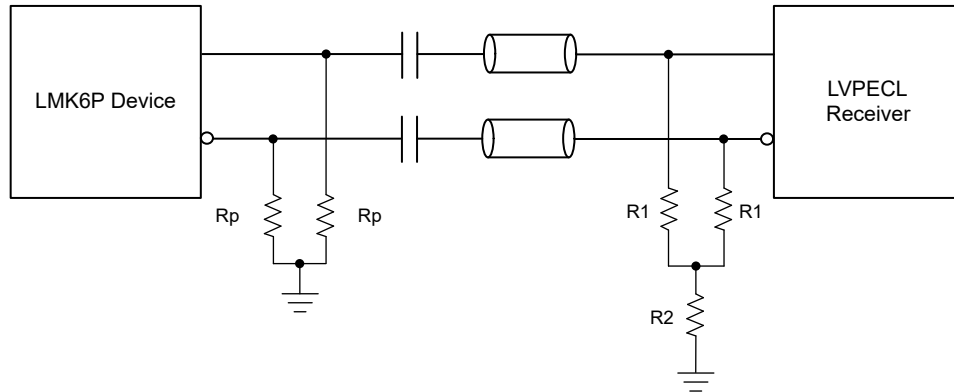

Figure 8-8. LMK6P Output AC-Coupled to LVPECL Receiver With External Termination/Biasing (Y-Network)

Table 8-6. LMK6P Y-Network AC-Coupled Resistor Values

SUPPLY (V)	Rp (Ω)	R1 (Ω)	R2 (Ω)
3.3	207.5	50	78.8
2.5	112.5	50	31.3
1.8	83.3	50	16.7

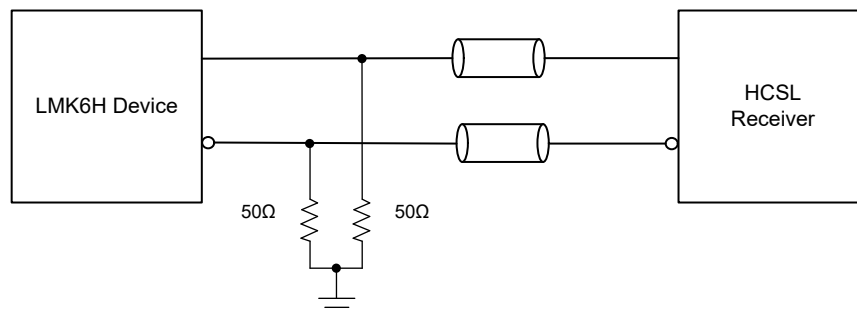

Figure 8-9. LMK6H Output to HCSL Receiver With External Termination

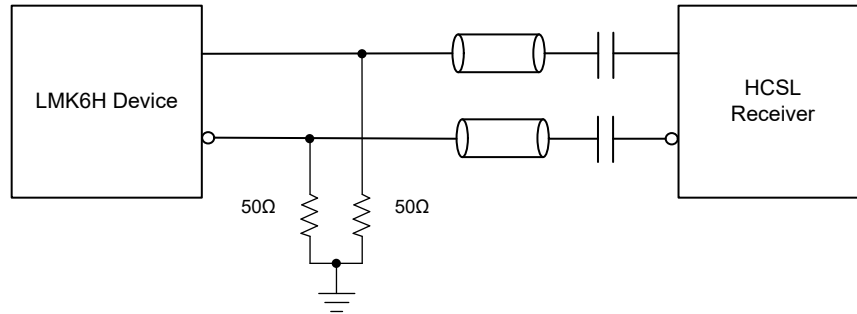

Figure 8-10. LMK6H Output AC-Coupled to HCSL Receiver With External Termination

8.3.5 Temperature Stability

Figure 8-11 shows the frequency variation of the LMK6x differential output oscillator over the temperature range of -40°C to 85°C for total of 60 units. Figure 8-12 shows the frequency variation of the LMK6C single-ended output oscillator over the operating temperature range of -40°C to 105°C . These plots represent the typical temperature stability of the device, remaining below $\pm 10\text{ppm}$. The devices are soldered onto the evaluation board as per the standard soldering profile and frequency variation measurements are carried out. The output frequency is 156.25MHz for these tests.

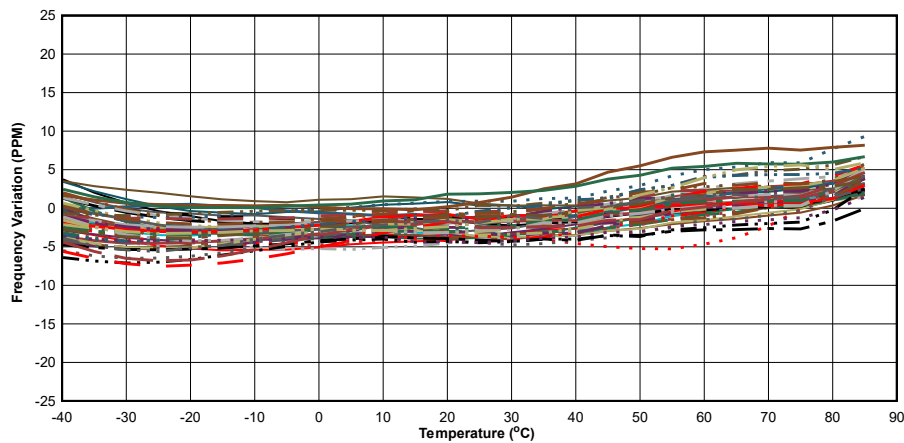

Figure 8-11. Frequency Change Over Temperature (LMK6x Differential Output Device)

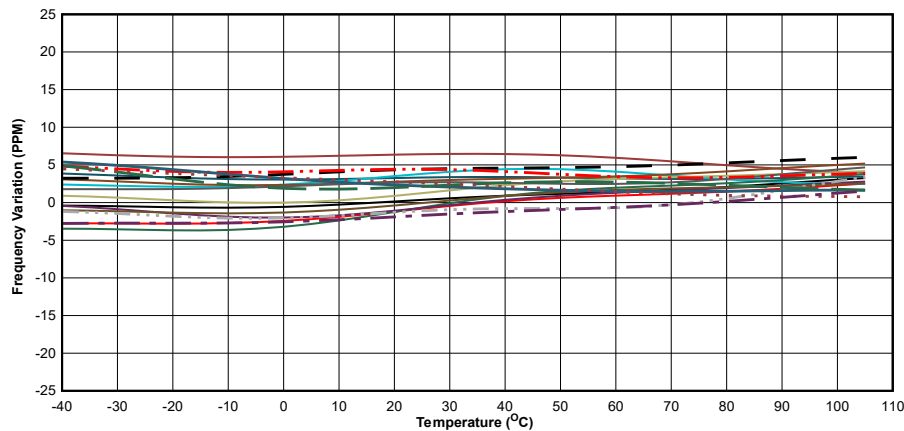

Figure 8-12. Frequency Change Over Temperature (LMK6C Single-Ended Output Device)

8.3.6 Mechanical Robustness

For reference oscillators, vibration and shock are common causes for increased phase noise and jitter, frequency shift and spikes, or even physical damages to the resonator and the package. Compared to quartz crystals, the BAW resonator is more immune to vibration and shock due to the orders of magnitude, smaller mass, and higher frequency, which means force applied to the device from acceleration is much smaller due to smaller mass.

Figure 8-13 shows the LMK6x BAW oscillator vibration performance. In this test, the LMK6x oscillator mounted on an EVM is subject to 10g acceleration force, ranging from 50Hz to 2kHz in x, y, and z-axis. Phase noise trace with spur due to vibration is captured using Keysight® E5052B and frequency deviation is calculated from the spur power. Then the frequency deviation is converted to ppb by noting the carrier frequency and normalized to ppb/g. Finally, the RMS sum of ppb/g along all three axes is reported as the Vibration sensitivity in ppb/g. LMK6x performance under vibration is approximately 2ppb/g while most quartz oscillators best case is 3ppb/g and worse can be above 10ppb/g.

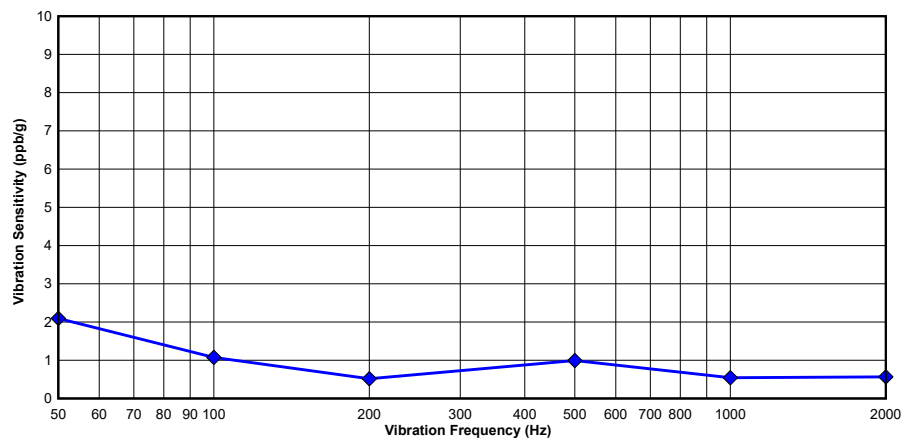

Figure 8-13. LMK6X BAW Oscillator Vibration Performance

8.4 Device Functional Modes

The LMK6x BAW Oscillator is a fixed output frequency device and does not require any programming. The device pin 1 (and pin 2 for a 6-pin device) has different functions. See the [Function Pins](#) section for more information on the function pins.

9 Application and Implementation

Note

Information in the following applications sections is not part of the TI component specification, and TI does not warrant its accuracy or completeness. TI's customers are responsible for determining suitability of components for their purposes, as well as validating and testing their design implementation to confirm system functionality.

9.1 Application Information

The LMK6x is high-performance, fixed-frequency oscillator that can be used as a reference clock. The product family supports any output frequency between 1MHz to 400MHz for differential LMK6D, LMK6H, LMK6P or 1MHz to 200MHz for singled-ended LVCMOS clock output types, and 1.8V or 2.5V through 3.3V supply rails.

9.2 Typical Application

For reference schematic implementation for LMK6x family of oscillators, refer to the [LMK6EVM User's Guide](#) for bypass capacitor and AC-coupling capacitor value recommendations. Refer to the [Clock Output Interfacing and Termination](#) section for output clock required termination and biasing.

Figure 9-1 shows a typical application example. The LMK6D differential oscillator is used as an input to the LVDS buffer input in this example.

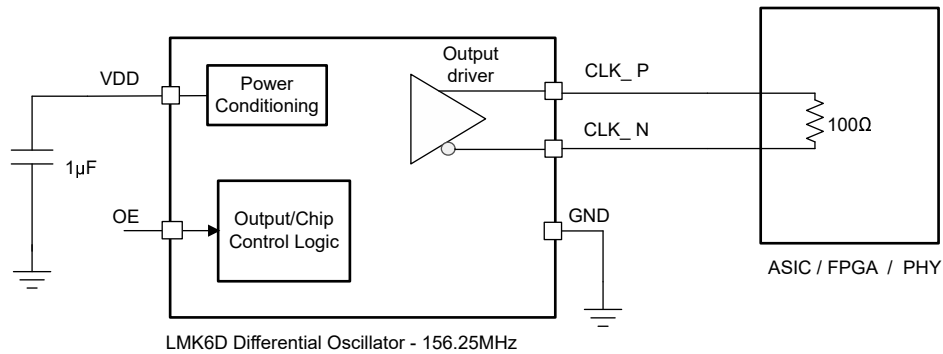

Figure 9-1. Application Example

9.2.1 Design Requirements

The LMK6x is a fixed-frequency oscillator with no programming needed. Make sure to follow the recommended termination options as described in the [Clock Output Interfacing and Termination](#) section closely. Refer to the [Function Pins](#) section to understand the pin 1 and pin 2 functions, and order the part number as per the requirements for Output Enable (OE), Standby (ST) options.

9.2.2 Detailed Design Procedure

The LMK6x has three different options for differential output which are LVDS, LVPECL, HCSL type and one LVCMOS single-ended output type. For designing with the any of the oscillator output type in actual system, use the proper AC or DC termination based on the application requirement. Refer to the [Clock Output Interfacing and Termination](#) section for the details of all the AC and DC termination schemes and use the appropriate option. The figures in this section have all the AC and DC coupling options with the termination resistor values. The LMK6x has an integrated LDO and has excellent PSRR performance as shown in the [Electrical Characteristics](#) table. Refer to the LMK6EVM for the reference layout recommendation while designing the LMK6x BAW oscillator.

For the Function Pin 1 of LMK6C, connect typical 10kΩ or less resistor to VDD for driving the OE pin High. Note this pin can be left open if using the pullup resistor is undesirable as the device has a greater than 100kΩ internal pullup resistor. For driving the OE pin to Low, use the typical 10kΩ or less resistor as a pulldown resistor. For the Function Pin 1 or Functional Pin 2 for LMK6D, LMK6H, LMK6P, you can use the similar approach described for LMK6C.

9.2.3 Application Curves

The LMK6C LVCMOS output connects to different load capacitances based on the actual application use case in a system. With the different load capacitance, the rise time / fall time varies for the specific output frequency. The following graphs shows the Rise / Fall time for load capacitance of 2.2pF, 4.7pF, 10pF, 15pF and 22pF for temperature range from -40°C to 105°C.

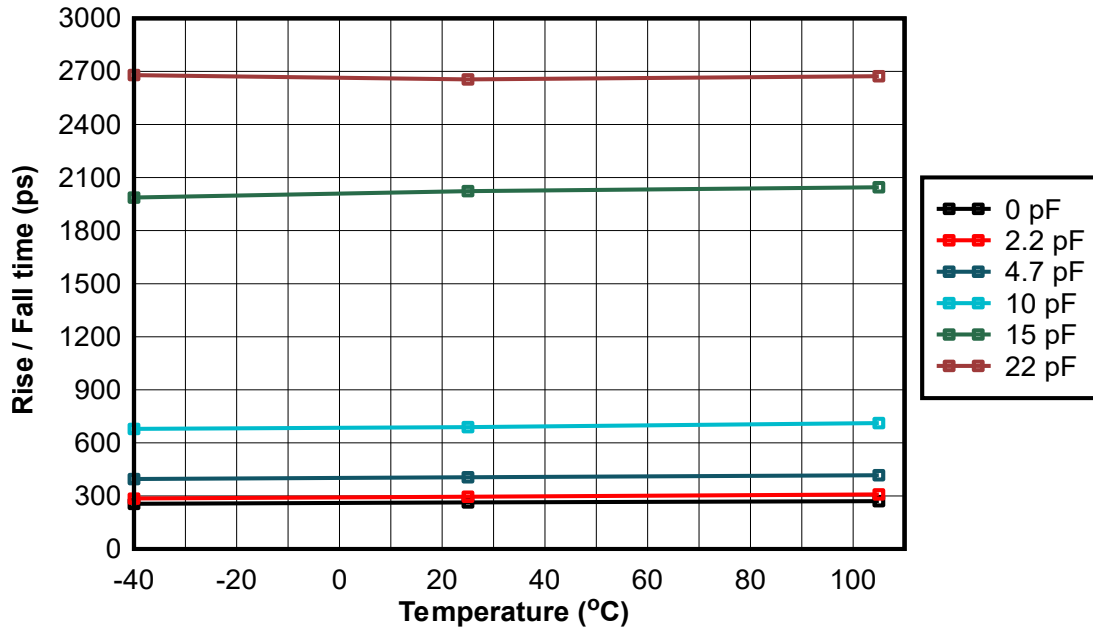

Figure 9-2. Rise / Fall time (ps) vs Temperature for 25MHz Output Frequency, 3.3V Supply

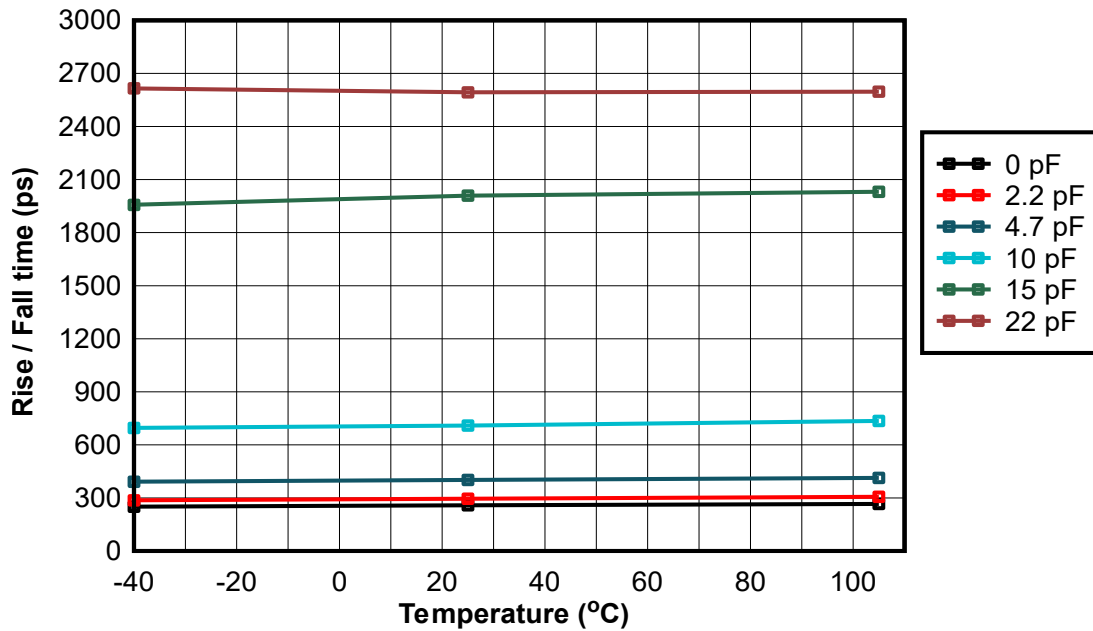

Figure 9-3. Rise / Fall time (ps) vs Temperature for 50MHz Output Frequency, 3.3V Supply

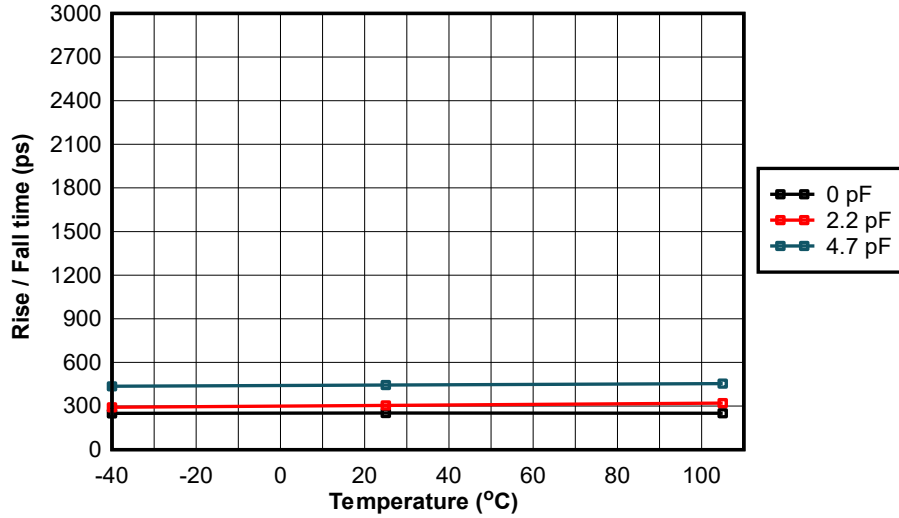

Figure 9-4. Rise / Fall time (ps) vs Temperature for 100MHz Output Frequency, 3.3V Supply

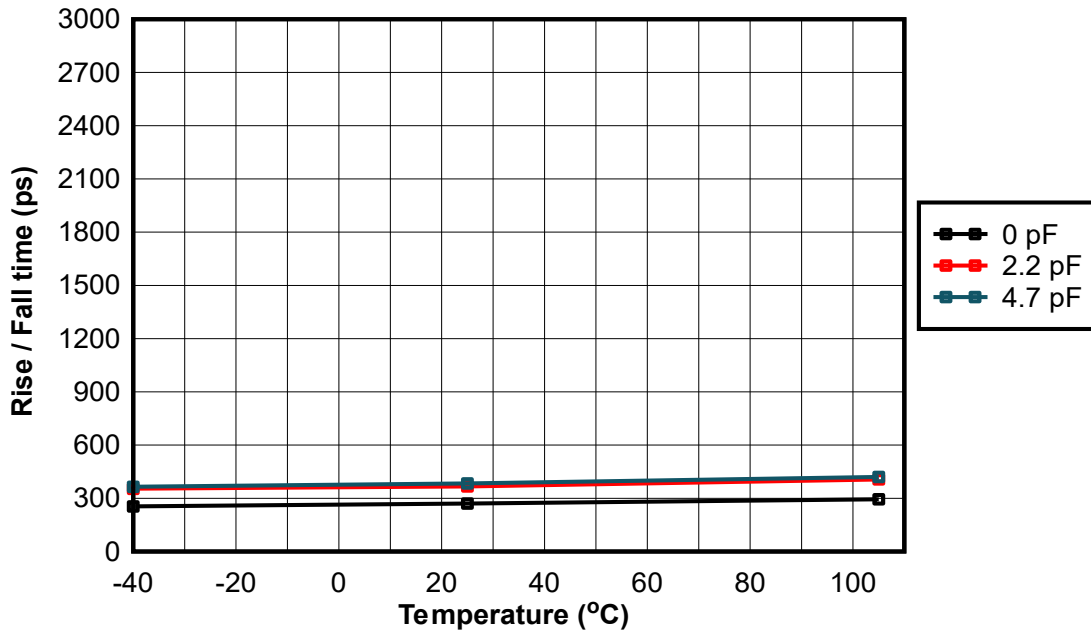

Figure 9-5. Rise / Fall time (ps) vs Temperature for 200MHz Output Frequency, 3.3V Supply

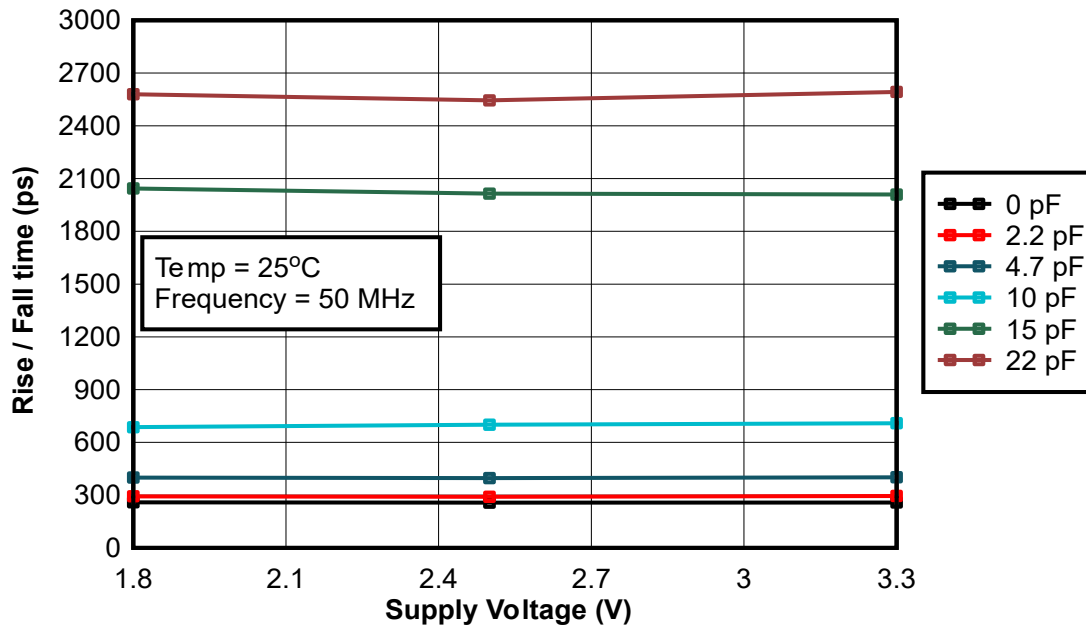

Figure 9-6. Rise / Fall time (ps) vs Supply Voltage vs Load Capacitance

9.3 Power Supply Recommendations

For the best electrical performance of the LMK6x, TI recommends using 1µF capacitor on the device power supply bypass network. TI also recommends using component side mounting of the power-supply bypass capacitors, and best to use 0201 or 0402 body size capacitors to facilitate signal routing. Keep the connections between the bypass capacitors and the power supply on the device as short as possible. Ground the other side of the capacitor using a low impedance connection to the ground plane.

9.4 Layout

9.4.1 Layout Guidelines

The following sections provide recommendations for board layout, solder reflow profile and power-supply bypassing when using the LMK6x to provide good thermal and electrical performance and signal integrity of the entire system.

9.4.1.1 Providing Thermal Reliability

The LMK6x is a high-performance device. Therefore, pay careful attention to device configuration and printed circuit board (PCB) layout with respect to power consumption. The ground pin must be connected to the ground plane of the PCB through three vias or more to maximize thermal dissipation out of the package.

Equation 1 describes the relationship between the PCB temperature around the LMK6x and the junction temperature.

$$T_B = T_J - \Psi_{JB} \times P \tag{1}$$

where

- T_B : PCB temperature around the LMK6x
- T_J : Junction temperature of LMK6x
- Ψ_{JB} : Junction-to-board thermal resistance parameter of LMK6x (refer to the *Thermal Information* tables in the [Specifications](#) section for this information)
- P: On-chip power dissipation of LMK6x

9.4.1.2 Recommended Solder Reflow Profile

TI recommends following the recommendations provided by the solder paste supplier to optimize flux activity and to achieve proper melting temperatures of the alloy within the guidelines of J-STD-20. Processing the LMK6x with the lowest peak temperature possible is preferable while also remaining below the components peak temperature rating as listed on the MSL label. The exact temperature profile depends on several factors including maximum peak temperature for the component as rated on the MSL label, Board thickness, PCB material type, PCB geometries, component locations, sizes, densities within PCB, as well as solder manufacturer's recommended profile, and capability of the reflow equipment to as confirmed by the SMT assembly operation.

9.4.2 Layout

Refer to the [LMK6EVM User's Guide](#) for printed circuit board layout examples for LMK6D, LMK6H, LMK6P and LMK6C devices. The figured below show the PCB layout example as done on the evaluation module for the LMK6x EVM.

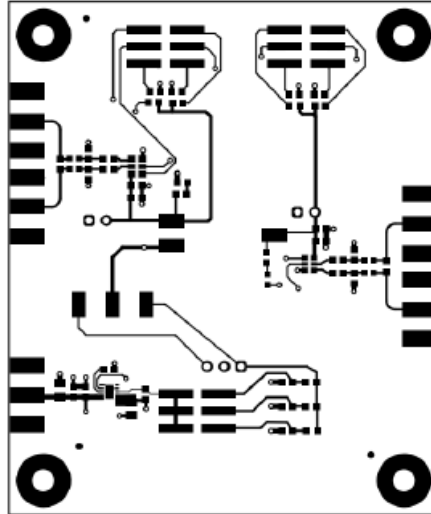

Figure 9-7. PCB Layout Example From LMK6 EVM - Top Layer

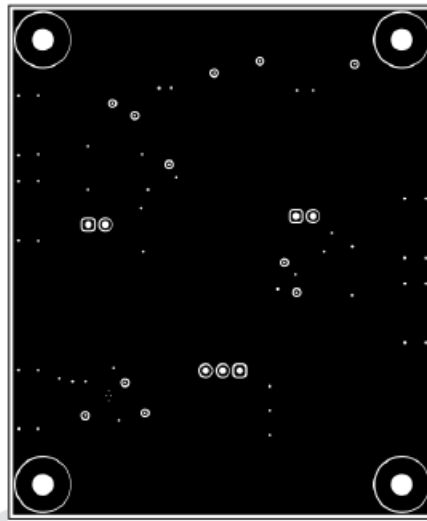

Figure 9-8. PCB Layout Example From LMK6 EVM - GND Layer 1

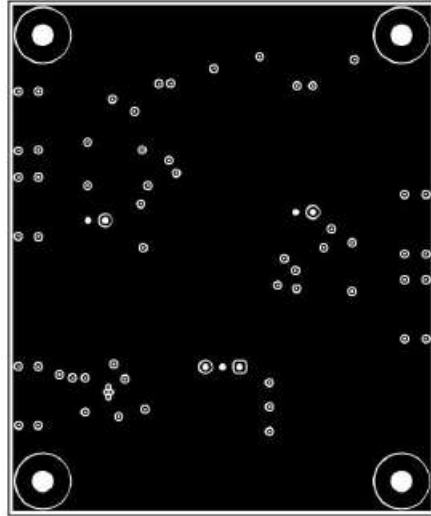

Figure 9-9. PCB Layout Example From LMK6 EVM - GND Layer 2

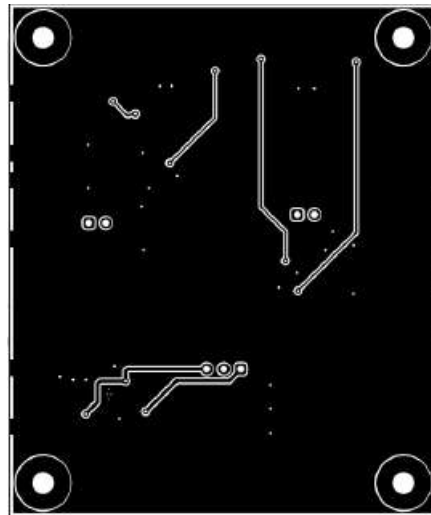

Figure 9-10. PCB Layout Example From LMK6 EVM - Bottom Layer

10 Device and Documentation Support

10.1 Documentation Support

10.1.1 Related Documentation

For related documentation, see the following:

- Texas Instruments, [LMK6EVM User's Guide](#)
- Texas Instruments, [Standalone BAW Oscillators Advantages Over Quartz Oscillators](#), application note
- Texas Instruments, [BAW oscillator solutions for Building Automation](#), application note
- Texas Instruments, [BAW oscillator solutions for Factory Automation](#), application note
- Texas Instruments, [BAW oscillator solutions for Grid Infrastructure](#), application note
- Texas Instruments, [BAW oscillator solutions for Optical Modules](#), application note

10.2 Receiving Notification of Documentation Updates

To receive notification of documentation updates, navigate to the device product folder on ti.com. Click on *Notifications* to register and receive a weekly digest of any product information that has changed. For change details, review the revision history included in any revised document.

10.3 Support Resources

TI E2E™ support forums are an engineer's go-to source for fast, verified answers and design help — straight from the experts. Search existing answers or ask your own question to get the quick design help you need.

Linked content is provided "AS IS" by the respective contributors. They do not constitute TI specifications and do not necessarily reflect TI's views; see TI's [Terms of Use](#).

10.4 Trademarks

TI E2E™ is a trademark of Texas Instruments.
 Keysight® is a registered trademark of Keysight Technologies, Inc..
 All trademarks are the property of their respective owners.

10.5 Electrostatic Discharge Caution



This integrated circuit can be damaged by ESD. Texas Instruments recommends that all integrated circuits be handled with appropriate precautions. Failure to observe proper handling and installation procedures can cause damage.

ESD damage can range from subtle performance degradation to complete device failure. Precision integrated circuits may be more susceptible to damage because very small parametric changes could cause the device not to meet its published specifications.

10.6 Glossary

[TI Glossary](#) This glossary lists and explains terms, acronyms, and definitions.

11 Revision History

NOTE: Page numbers for previous revisions may differ from page numbers in the current version.

Changes from Revision F (February 2025) to Revision G (March 2025)	Page
• Updated the number formatting for tables, figures, and cross-references throughout the document.....	1
• Added jitter specifications with PCIe Gen 7 throughout the document.....	1
• Added <i>LMK6P Output DC-Coupled to LVPECL Receiver With External Termination/Biasing (50Ω to VDD - 2V)</i> to show option for 50Ω to VDD-2V termination for LMK6P.....	23

Changes from Revision E (January 2024) to Revision F (February 2025)	Page
• Updated the number formatting for tables, figures, and cross-references throughout the document.....	1

- Changed the title of the *Device Ordering Information* section to "Device Nomenclature" and moved to the *Device and Documentation Support* section. Updated "Part Number Guide: LMK6C" Figure and added link to LMK6x OPN Decoder application note.....3
- Changed *Ensuring Thermal Reliability* section title to "Providing Thermal Reliability".....32

Changes from Revision D (February 2023) to Revision E (January 2024) Page

- Added values to the list of standard frequencies.....1
- Changed the part number guides in the *Device Ordering Information* section.....3

Changes from Revision C (December 2022) to Revision D (February 2023) Page

- Changed the NO. column to DLE/DLF in the *Pin Functions* table for the DLF package release.....5

Changes from Revision B (November 2022) to Revision C (December 2022) Page

- Changed the data sheet status from Advanced Information to Production Data.....1
- Removed the preview note from the LMK6D, LMK6H, and LMK6P devices.....1

12 Mechanical, Packaging, and Orderable Information

The following pages include mechanical, packaging, and orderable information. This information is the most current data available for the designated devices. This data is subject to change without notice and revision of this document. For browser-based versions of this data sheet, refer to the left-hand navigation.

PACKAGING INFORMATION

Orderable part number	Status (1)	Material type (2)	Package Pins	Package qty Carrier	RoHS (3)	Lead finish/ Ball material (4)	MSL rating/ Peak reflow (5)	Op temp (°C)	Part marking (6)
LMK6CA026214DDLFR	Active	Production	VSON (DLF) 4	3000 LARGE T&R	Yes	Call TI	Level-1-260C-UNLIM	-40 to 105	HC3O
LMK6CA026214DDLFR.A	Active	Production	VSON (DLF) 4	3000 LARGE T&R	Yes	Call TI	Level-1-260C-UNLIM	-40 to 105	HC3O
LMK6CA026214DDLFR.B	Active	Production	VSON (DLF) 4	3000 LARGE T&R	Yes	Call TI	Level-1-260C-UNLIM	-40 to 105	HC3O
LMK6CA032768DDLFR	Active	Production	VSON (DLF) 4	3000 LARGE T&R	Yes	Call TI	Level-1-260C-UNLIM	-40 to 105	HC3P
LMK6CA032768DDLFR.A	Active	Production	VSON (DLF) 4	3000 LARGE T&R	Yes	Call TI	Level-1-260C-UNLIM	-40 to 105	HC3P
LMK6CA032768DDLFR.B	Active	Production	VSON (DLF) 4	3000 LARGE T&R	Yes	Call TI	Level-1-260C-UNLIM	-40 to 105	HC3P
LMK6CA048000CDLFR	Active	Production	VSON (DLF) 4	3000 LARGE T&R	Yes	Call TI	Level-1-260C-UNLIM	-40 to 105	LCDC
LMK6CA048000CDLFR.A	Active	Production	VSON (DLF) 4	3000 LARGE T&R	Yes	Call TI	Level-1-260C-UNLIM	-40 to 105	LCDC
LMK6CA048000CDLFR.B	Active	Production	VSON (DLF) 4	3000 LARGE T&R	Yes	Call TI	Level-1-260C-UNLIM	-40 to 105	LCDC
LMK6CE001000DDLFR	Active	Production	VSON (DLE) 4	3000 LARGE T&R	Yes	Call TI	Level-1-260C-UNLIM	-40 to 105	LC1R
LMK6CE001000DDLFR.A	Active	Production	VSON (DLE) 4	3000 LARGE T&R	Yes	Call TI	Level-1-260C-UNLIM	-40 to 105	LC1R
LMK6CE001000DDLFR.B	Active	Production	VSON (DLE) 4	3000 LARGE T&R	Yes	Call TI	Level-1-260C-UNLIM	-40 to 105	LC1R
LMK6CE001000DDLFR	Active	Production	VSON (DLF) 4	3000 LARGE T&R	Yes	Call TI	Level-1-260C-UNLIM	-40 to 105	LC1R
LMK6CE001000DDLFR.A	Active	Production	VSON (DLF) 4	3000 LARGE T&R	Yes	Call TI	Level-1-260C-UNLIM	-40 to 105	LC1R
LMK6CE001000DDLFR.B	Active	Production	VSON (DLF) 4	3000 LARGE T&R	Yes	Call TI	Level-1-260C-UNLIM	-40 to 105	LC1R
LMK6CE001200CDLFR	Active	Production	VSON (DLF) 4	3000 LARGE T&R	Yes	Call TI	Level-1-260C-UNLIM	-40 to 105	LCBO
LMK6CE001200CDLFR.A	Active	Production	VSON (DLF) 4	3000 LARGE T&R	Yes	Call TI	Level-1-260C-UNLIM	-40 to 105	LCBO
LMK6CE001200CDLFR.B	Active	Production	VSON (DLF) 4	3000 LARGE T&R	Yes	Call TI	Level-1-260C-UNLIM	-40 to 105	LCBO
LMK6CE008000CDLFR	Active	Production	VSON (DLF) 4	3000 LARGE T&R	Yes	Call TI	Level-1-260C-UNLIM	-40 to 105	LCBZ
LMK6CE012288CDLFR	Active	Production	VSON (DLF) 4	3000 LARGE T&R	Yes	Call TI	Level-1-260C-UNLIM	-40 to 105	LCBJ
LMK6CE012288CDLFR.A	Active	Production	VSON (DLF) 4	3000 LARGE T&R	Yes	Call TI	Level-1-260C-UNLIM	-40 to 105	LCBJ
LMK6CE012288CDLFR.B	Active	Production	VSON (DLF) 4	3000 LARGE T&R	Yes	Call TI	Level-1-260C-UNLIM	-40 to 105	LCBJ
LMK6CE016000CDLER	Active	Production	VSON (DLE) 4	3000 LARGE T&R	Yes	Call TI	Level-1-260C-UNLIM	-40 to 105	HCBK
LMK6CE016000CDLER.A	Active	Production	VSON (DLE) 4	3000 LARGE T&R	Yes	Call TI	Level-1-260C-UNLIM	-40 to 105	HCBK
LMK6CE016000CDLER.B	Active	Production	VSON (DLE) 4	3000 LARGE T&R	Yes	Call TI	Level-1-260C-UNLIM	-40 to 105	HCBK
LMK6CE019200CDLER	Active	Production	VSON (DLE) 4	3000 LARGE T&R	Yes	Call TI	Level-1-260C-UNLIM	-40 to 105	HCBB
LMK6CE019200CDLER.A	Active	Production	VSON (DLE) 4	3000 LARGE T&R	Yes	Call TI	Level-1-260C-UNLIM	-40 to 105	HCBB
LMK6CE019200CDLER.B	Active	Production	VSON (DLE) 4	3000 LARGE T&R	Yes	Call TI	Level-1-260C-UNLIM	-40 to 105	HCBB
LMK6CE02000CDLER	Active	Production	VSON (DLE) 4	3000 LARGE T&R	Yes	Call TI	Level-1-260C-UNLIM	-40 to 105	HCBA

Orderable part number	Status (1)	Material type (2)	Package Pins	Package qty Carrier	RoHS (3)	Lead finish/ Ball material (4)	MSL rating/ Peak reflow (5)	Op temp (°C)	Part marking (6)
LMK6CE02000CDLER.A	Active	Production	VSON (DLE) 4	3000 LARGE T&R	Yes	Call TI	Level-1-260C-UNLIM	-40 to 105	HCBA
LMK6CE02000CDLER.B	Active	Production	VSON (DLE) 4	3000 LARGE T&R	Yes	Call TI	Level-1-260C-UNLIM	-40 to 105	HCBA
LMK6CE02000CDLFR	Active	Production	VSON (DLF) 4	3000 LARGE T&R	Yes	Call TI	Level-1-260C-UNLIM	-40 to 105	HCBA
LMK6CE02000CDLFR.A	Active	Production	VSON (DLF) 4	3000 LARGE T&R	Yes	Call TI	Level-1-260C-UNLIM	-40 to 105	HCBA
LMK6CE02000CDLFR.B	Active	Production	VSON (DLF) 4	3000 LARGE T&R	Yes	Call TI	Level-1-260C-UNLIM	-40 to 105	HCBA
LMK6CE02400CDLER	Active	Production	VSON (DLE) 4	3000 LARGE T&R	Yes	Call TI	Level-1-260C-UNLIM	-40 to 105	LCBI
LMK6CE02400CDLER.A	Active	Production	VSON (DLE) 4	3000 LARGE T&R	Yes	Call TI	Level-1-260C-UNLIM	-40 to 105	LCBI
LMK6CE02400CDLER.B	Active	Production	VSON (DLE) 4	3000 LARGE T&R	Yes	Call TI	Level-1-260C-UNLIM	-40 to 105	LCBI
LMK6CE02400CDLFR	Active	Production	VSON (DLF) 4	3000 LARGE T&R	Yes	Call TI	Level-1-260C-UNLIM	-40 to 105	LCBI
LMK6CE02400CDLFR.A	Active	Production	VSON (DLF) 4	3000 LARGE T&R	Yes	Call TI	Level-1-260C-UNLIM	-40 to 105	LCBI
LMK6CE02400CDLFR.B	Active	Production	VSON (DLF) 4	3000 LARGE T&R	Yes	Call TI	Level-1-260C-UNLIM	-40 to 105	LCBI
LMK6CE024576CDLFR	Active	Production	VSON (DLF) 4	3000 LARGE T&R	Yes	Call TI	Level-1-260C-UNLIM	-40 to 105	LCBH
LMK6CE024576CDLFR.A	Active	Production	VSON (DLF) 4	3000 LARGE T&R	Yes	Call TI	Level-1-260C-UNLIM	-40 to 105	LCBH
LMK6CE024576CDLFR.B	Active	Production	VSON (DLF) 4	3000 LARGE T&R	Yes	Call TI	Level-1-260C-UNLIM	-40 to 105	LCBH
LMK6CE02500CDLER	Active	Production	VSON (DLE) 4	3000 LARGE T&R	Yes	Call TI	Level-1-260C-UNLIM	-40 to 105	LCBG
LMK6CE02500CDLER.A	Active	Production	VSON (DLE) 4	3000 LARGE T&R	Yes	Call TI	Level-1-260C-UNLIM	-40 to 105	LCBG
LMK6CE02500CDLER.B	Active	Production	VSON (DLE) 4	3000 LARGE T&R	Yes	Call TI	Level-1-260C-UNLIM	-40 to 105	LCBG
LMK6CE02500CDLFR	Active	Production	VSON (DLF) 4	3000 LARGE T&R	Yes	Call TI	Level-1-260C-UNLIM	-40 to 105	LCBG
LMK6CE02500CDLFR.A	Active	Production	VSON (DLF) 4	3000 LARGE T&R	Yes	Call TI	Level-1-260C-UNLIM	-40 to 105	LCBG
LMK6CE02500CDLFR.B	Active	Production	VSON (DLF) 4	3000 LARGE T&R	Yes	Call TI	Level-1-260C-UNLIM	-40 to 105	LCBG
LMK6CE02500DDLER	Active	Production	VSON (DLE) 4	3000 LARGE T&R	Yes	Call TI	Level-1-260C-UNLIM	-40 to 105	LC1G
LMK6CE02500DDLER.A	Active	Production	VSON (DLE) 4	3000 LARGE T&R	Yes	Call TI	Level-1-260C-UNLIM	-40 to 105	LC1G
LMK6CE02500DDLER.B	Active	Production	VSON (DLE) 4	3000 LARGE T&R	Yes	Call TI	Level-1-260C-UNLIM	-40 to 105	LC1G
LMK6CE02500DDLFR	Active	Production	VSON (DLF) 4	3000 LARGE T&R	Yes	Call TI	Level-1-260C-UNLIM	-40 to 105	LC1G
LMK6CE02500DDLFR.A	Active	Production	VSON (DLF) 4	3000 LARGE T&R	Yes	Call TI	Level-1-260C-UNLIM	-40 to 105	LC1G
LMK6CE02500DDLFR.B	Active	Production	VSON (DLF) 4	3000 LARGE T&R	Yes	Call TI	Level-1-260C-UNLIM	-40 to 105	LC1G
LMK6CE027000CDLER	Active	Production	VSON (DLE) 4	3000 LARGE T&R	Yes	Call TI	Level-1-260C-UNLIM	-40 to 105	HCB9
LMK6CE027000CDLER.A	Active	Production	VSON (DLE) 4	3000 LARGE T&R	Yes	Call TI	Level-1-260C-UNLIM	-40 to 105	HCB9
LMK6CE027000CDLER.B	Active	Production	VSON (DLE) 4	3000 LARGE T&R	Yes	Call TI	Level-1-260C-UNLIM	-40 to 105	HCB9
LMK6CE027000CDLFR	Active	Production	VSON (DLF) 4	3000 LARGE T&R	Yes	Call TI	Level-1-260C-UNLIM	-40 to 105	HCB9
LMK6CE027000CDLFR.A	Active	Production	VSON (DLF) 4	3000 LARGE T&R	Yes	Call TI	Level-1-260C-UNLIM	-40 to 105	HCB9

Orderable part number	Status (1)	Material type (2)	Package Pins	Package qty Carrier	RoHS (3)	Lead finish/ Ball material (4)	MSL rating/ Peak reflow (5)	Op temp (°C)	Part marking (6)
LMK6CE027000CDLFR.B	Active	Production	VSON (DLF) 4	3000 LARGE T&R	Yes	Call TI	Level-1-260C-UNLIM	-40 to 105	HCB9
LMK6CE028125CDLFR	Active	Production	VSON (DLF) 4	3000 LARGE T&R	Yes	Call TI	Level-1-260C-UNLIM	-40 to 105	HCBJ
LMK6CE028125CDLFR.A	Active	Production	VSON (DLF) 4	3000 LARGE T&R	Yes	Call TI	Level-1-260C-UNLIM	-40 to 105	HCBJ
LMK6CE028125CDLFR.B	Active	Production	VSON (DLF) 4	3000 LARGE T&R	Yes	Call TI	Level-1-260C-UNLIM	-40 to 105	HCBJ
LMK6CE030000CDLFR	Active	Production	VSON (DLF) 4	3000 LARGE T&R	Yes	Call TI	Level-1-260C-UNLIM	-40 to 105	LCBD
LMK6CE030000CDLFR.A	Active	Production	VSON (DLF) 4	3000 LARGE T&R	Yes	Call TI	Level-1-260C-UNLIM	-40 to 105	LCBD
LMK6CE030000CDLFR.B	Active	Production	VSON (DLF) 4	3000 LARGE T&R	Yes	Call TI	Level-1-260C-UNLIM	-40 to 105	LCBD
LMK6CE033333DDLFR	Active	Production	VSON (DLF) 4	3000 LARGE T&R	Yes	Call TI	Level-1-260C-UNLIM	-40 to 105	HC18
LMK6CE033333DDLFR.A	Active	Production	VSON (DLF) 4	3000 LARGE T&R	Yes	Call TI	Level-1-260C-UNLIM	-40 to 105	HC18
LMK6CE033333DDLFR.B	Active	Production	VSON (DLF) 4	3000 LARGE T&R	Yes	Call TI	Level-1-260C-UNLIM	-40 to 105	HC18
LMK6CE033333ACDLER	Active	Production	VSON (DLE) 4	3000 LARGE T&R	Yes	Call TI	Level-1-260C-UNLIM	-40 to 105	HCBT
LMK6CE033333ACDLER.A	Active	Production	VSON (DLE) 4	3000 LARGE T&R	Yes	Call TI	Level-1-260C-UNLIM	-40 to 105	HCBT
LMK6CE033333ACDLER.B	Active	Production	VSON (DLE) 4	3000 LARGE T&R	Yes	Call TI	Level-1-260C-UNLIM	-40 to 105	HCBT
LMK6CE033333CDLER	Active	Production	VSON (DLE) 4	3000 LARGE T&R	Yes	Call TI	Level-1-260C-UNLIM	-40 to 105	HCB8
LMK6CE033333CDLER.A	Active	Production	VSON (DLE) 4	3000 LARGE T&R	Yes	Call TI	Level-1-260C-UNLIM	-40 to 105	HCB8
LMK6CE033333CDLER.B	Active	Production	VSON (DLE) 4	3000 LARGE T&R	Yes	Call TI	Level-1-260C-UNLIM	-40 to 105	HCB8
LMK6CE033550CDLER	Active	Production	VSON (DLE) 4	3000 LARGE T&R	Yes	Call TI	Level-1-260C-UNLIM	-40 to 105	LCBY
LMK6CE033550CDLER.A	Active	Production	VSON (DLE) 4	3000 LARGE T&R	Yes	Call TI	Level-1-260C-UNLIM	-40 to 105	LCBY
LMK6CE033550CDLER.B	Active	Production	VSON (DLE) 4	3000 LARGE T&R	Yes	Call TI	Level-1-260C-UNLIM	-40 to 105	LCBY
LMK6CE040000CDLFR	Active	Production	VSON (DLF) 4	3000 LARGE T&R	Yes	Call TI	Level-1-260C-UNLIM	-40 to 105	HCB6
LMK6CE040000CDLFR.A	Active	Production	VSON (DLF) 4	3000 LARGE T&R	Yes	Call TI	Level-1-260C-UNLIM	-40 to 105	HCB6
LMK6CE040000CDLFR.B	Active	Production	VSON (DLF) 4	3000 LARGE T&R	Yes	Call TI	Level-1-260C-UNLIM	-40 to 105	HCB6
LMK6CE048000CDLER	Active	Production	VSON (DLE) 4	3000 LARGE T&R	Yes	Call TI	Level-1-260C-UNLIM	-40 to 105	LCBC
LMK6CE048000CDLER.A	Active	Production	VSON (DLE) 4	3000 LARGE T&R	Yes	Call TI	Level-1-260C-UNLIM	-40 to 105	LCBC
LMK6CE048000CDLER.B	Active	Production	VSON (DLE) 4	3000 LARGE T&R	Yes	Call TI	Level-1-260C-UNLIM	-40 to 105	LCBC
LMK6CE048000CDLFR	Active	Production	VSON (DLF) 4	3000 LARGE T&R	Yes	Call TI	Level-1-260C-UNLIM	-40 to 105	LCBC
LMK6CE048000CDLFR.A	Active	Production	VSON (DLF) 4	3000 LARGE T&R	Yes	Call TI	Level-1-260C-UNLIM	-40 to 105	LCBC
LMK6CE048000CDLFR.B	Active	Production	VSON (DLF) 4	3000 LARGE T&R	Yes	Call TI	Level-1-260C-UNLIM	-40 to 105	LCBC
LMK6CE048000DDLFR	Active	Production	VSON (DLF) 4	3000 LARGE T&R	Yes	Call TI	Level-1-260C-UNLIM	-40 to 105	LC1C
LMK6CE048000DDLFR.A	Active	Production	VSON (DLF) 4	3000 LARGE T&R	Yes	Call TI	Level-1-260C-UNLIM	-40 to 105	LC1C
LMK6CE048000DDLFR.B	Active	Production	VSON (DLF) 4	3000 LARGE T&R	Yes	Call TI	Level-1-260C-UNLIM	-40 to 105	LC1C

Orderable part number	Status (1)	Material type (2)	Package Pins	Package qty Carrier	RoHS (3)	Lead finish/ Ball material (4)	MSL rating/ Peak reflow (5)	Op temp (°C)	Part marking (6)
LMK6CE049152CDLFR	Active	Production	VSON (DLF) 4	3000 LARGE T&R	Yes	Call TI	Level-1-260C-UNLIM	-40 to 105	HCBR
LMK6CE049152CDLFR.A	Active	Production	VSON (DLF) 4	3000 LARGE T&R	Yes	Call TI	Level-1-260C-UNLIM	-40 to 105	HCBR
LMK6CE049152CDLFR.B	Active	Production	VSON (DLF) 4	3000 LARGE T&R	Yes	Call TI	Level-1-260C-UNLIM	-40 to 105	HCBR
LMK6CE050000DDLFR	Active	Production	VSON (DLF) 4	3000 LARGE T&R	Yes	Call TI	Level-1-260C-UNLIM	-40 to 105	LC1B
LMK6CE050000DDLFR.A	Active	Production	VSON (DLF) 4	3000 LARGE T&R	Yes	Call TI	Level-1-260C-UNLIM	-40 to 105	LC1B
LMK6CE050000DDLFR.B	Active	Production	VSON (DLF) 4	3000 LARGE T&R	Yes	Call TI	Level-1-260C-UNLIM	-40 to 105	LC1B
LMK6CE05000CDLER	Active	Production	VSON (DLE) 4	3000 LARGE T&R	Yes	Call TI	Level-1-260C-UNLIM	-40 to 105	LCCB
LMK6CE05000CDLER.A	Active	Production	VSON (DLE) 4	3000 LARGE T&R	Yes	Call TI	Level-1-260C-UNLIM	-40 to 105	LCCB
LMK6CE05000CDLER.B	Active	Production	VSON (DLE) 4	3000 LARGE T&R	Yes	Call TI	Level-1-260C-UNLIM	-40 to 105	LCCB
LMK6CE05000CDLFR	Active	Production	VSON (DLF) 4	3000 LARGE T&R	Yes	Call TI	Level-1-260C-UNLIM	-40 to 105	LCCB
LMK6CE05000CDLFR.A	Active	Production	VSON (DLF) 4	3000 LARGE T&R	Yes	Call TI	Level-1-260C-UNLIM	-40 to 105	LCCB
LMK6CE05000CDLFR.B	Active	Production	VSON (DLF) 4	3000 LARGE T&R	Yes	Call TI	Level-1-260C-UNLIM	-40 to 105	LCCB
LMK6CE05000DDLER	Active	Production	VSON (DLE) 4	3000 LARGE T&R	Yes	Call TI	Level-1-260C-UNLIM	-40 to 105	LC1B
LMK6CE05000DDLER.A	Active	Production	VSON (DLE) 4	3000 LARGE T&R	Yes	Call TI	Level-1-260C-UNLIM	-40 to 105	LC1B
LMK6CE05000DDLER.B	Active	Production	VSON (DLE) 4	3000 LARGE T&R	Yes	Call TI	Level-1-260C-UNLIM	-40 to 105	LC1B
LMK6CE05000DDLFR	Active	Production	VSON (DLF) 4	3000 LARGE T&R	Yes	Call TI	Level-1-260C-UNLIM	-40 to 105	LC1B
LMK6CE05000DDLFR.A	Active	Production	VSON (DLF) 4	3000 LARGE T&R	Yes	Call TI	Level-1-260C-UNLIM	-40 to 105	LC1B
LMK6CE05000DDLFR.B	Active	Production	VSON (DLF) 4	3000 LARGE T&R	Yes	Call TI	Level-1-260C-UNLIM	-40 to 105	LC1B
LMK6CE06666CDLER	Active	Production	VSON (DLE) 4	3000 LARGE T&R	Yes	Call TI	Level-1-260C-UNLIM	-40 to 105	LCBA
LMK6CE06666CDLER.A	Active	Production	VSON (DLE) 4	3000 LARGE T&R	Yes	Call TI	Level-1-260C-UNLIM	-40 to 105	LCBA
LMK6CE06666CDLER.B	Active	Production	VSON (DLE) 4	3000 LARGE T&R	Yes	Call TI	Level-1-260C-UNLIM	-40 to 105	LCBA
LMK6CE07425DDLFR	Active	Production	VSON (DLF) 4	3000 LARGE T&R	Yes	Call TI	Level-1-260C-UNLIM	-40 to 105	LC19
LMK6CE07425DDLFR.A	Active	Production	VSON (DLF) 4	3000 LARGE T&R	Yes	Call TI	Level-1-260C-UNLIM	-40 to 105	LC19
LMK6CE07425DDLFR.B	Active	Production	VSON (DLF) 4	3000 LARGE T&R	Yes	Call TI	Level-1-260C-UNLIM	-40 to 105	LC19
LMK6CE10000CDLER	Active	Production	VSON (DLE) 4	3000 LARGE T&R	Yes	Call TI	Level-1-260C-UNLIM	-40 to 105	LCB8
LMK6CE10000CDLER.A	Active	Production	VSON (DLE) 4	3000 LARGE T&R	Yes	Call TI	Level-1-260C-UNLIM	-40 to 105	LCB8
LMK6CE10000CDLER.B	Active	Production	VSON (DLE) 4	3000 LARGE T&R	Yes	Call TI	Level-1-260C-UNLIM	-40 to 105	LCB8
LMK6CE10000CDLFR	Active	Production	VSON (DLF) 4	3000 LARGE T&R	Yes	Call TI	Level-1-260C-UNLIM	-40 to 105	LCB8
LMK6CE10000CDLFR.A	Active	Production	VSON (DLF) 4	3000 LARGE T&R	Yes	Call TI	Level-1-260C-UNLIM	-40 to 105	LCB8
LMK6CE10000CDLFR.B	Active	Production	VSON (DLF) 4	3000 LARGE T&R	Yes	Call TI	Level-1-260C-UNLIM	-40 to 105	LCB8
LMK6CE10000DDLER	Active	Production	VSON (DLE) 4	3000 LARGE T&R	Yes	Call TI	Level-1-260C-UNLIM	-40 to 105	LC18

Orderable part number	Status (1)	Material type (2)	Package Pins	Package qty Carrier	RoHS (3)	Lead finish/ Ball material (4)	MSL rating/ Peak reflow (5)	Op temp (°C)	Part marking (6)
LMK6CE1000DDLER.A	Active	Production	VSON (DLE) 4	3000 LARGE T&R	Yes	Call TI	Level-1-260C-UNLIM	-40 to 105	LC18
LMK6CE1000DDLER.B	Active	Production	VSON (DLE) 4	3000 LARGE T&R	Yes	Call TI	Level-1-260C-UNLIM	-40 to 105	LC18
LMK6CE1000DDLFR	Active	Production	VSON (DLF) 4	3000 LARGE T&R	Yes	Call TI	Level-1-260C-UNLIM	-40 to 105	LC18
LMK6CE1000DDLFR.A	Active	Production	VSON (DLF) 4	3000 LARGE T&R	Yes	Call TI	Level-1-260C-UNLIM	-40 to 105	LC18
LMK6CE1000DDLFR.B	Active	Production	VSON (DLF) 4	3000 LARGE T&R	Yes	Call TI	Level-1-260C-UNLIM	-40 to 105	LC18
LMK6CE1080DDLFR	Active	Production	VSON (DLF) 4	3000 LARGE T&R	Yes	Call TI	Level-1-260C-UNLIM	-40 to 105	HC11
LMK6CE1080DDLFR.A	Active	Production	VSON (DLF) 4	3000 LARGE T&R	Yes	Call TI	Level-1-260C-UNLIM	-40 to 105	HC11
LMK6CE1080DDLFR.B	Active	Production	VSON (DLF) 4	3000 LARGE T&R	Yes	Call TI	Level-1-260C-UNLIM	-40 to 105	HC11
LMK6CE12500DDLER	Active	Production	VSON (DLE) 4	3000 LARGE T&R	Yes	Call TI	Level-1-260C-UNLIM	-40 to 105	LC16
LMK6CE12500DDLER.A	Active	Production	VSON (DLE) 4	3000 LARGE T&R	Yes	Call TI	Level-1-260C-UNLIM	-40 to 105	LC16
LMK6CE12500DDLER.B	Active	Production	VSON (DLE) 4	3000 LARGE T&R	Yes	Call TI	Level-1-260C-UNLIM	-40 to 105	LC16
LMK6CE12500CDLER	Active	Production	VSON (DLE) 4	3000 LARGE T&R	Yes	Call TI	Level-1-260C-UNLIM	-40 to 105	LCB6
LMK6CE12500CDLER.A	Active	Production	VSON (DLE) 4	3000 LARGE T&R	Yes	Call TI	Level-1-260C-UNLIM	-40 to 105	LCB6
LMK6CE12500CDLER.B	Active	Production	VSON (DLE) 4	3000 LARGE T&R	Yes	Call TI	Level-1-260C-UNLIM	-40 to 105	LCB6
LMK6CE15625DDLFR	Active	Production	VSON (DLF) 4	3000 LARGE T&R	Yes	Call TI	Level-1-260C-UNLIM	-40 to 105	LC12
LMK6CE15625DDLFR.A	Active	Production	VSON (DLF) 4	3000 LARGE T&R	Yes	Call TI	Level-1-260C-UNLIM	-40 to 105	LC12
LMK6CE15625DDLFR.B	Active	Production	VSON (DLF) 4	3000 LARGE T&R	Yes	Call TI	Level-1-260C-UNLIM	-40 to 105	LC12
LMK6DA02500ADLFR	Active	Production	VSON (DLF) 6	3000 LARGE T&R	Yes	Call TI	Level-1-260C-UNLIM	-40 to 85	LDAG
LMK6DA02500ADLFR.A	Active	Production	VSON (DLF) 6	3000 LARGE T&R	Yes	Call TI	Level-1-260C-UNLIM	-40 to 85	LDAG
LMK6DA02500ADLFR.B	Active	Production	VSON (DLF) 6	3000 LARGE T&R	Yes	Call TI	Level-1-260C-UNLIM	-40 to 85	LDAG
LMK6DA05184ADLER	Active	Production	VSON (DLE) 6	3000 LARGE T&R	Yes	Call TI	Level-1-260C-UNLIM	-40 to 85	HDAH
LMK6DA05184ADLER.A	Active	Production	VSON (DLE) 6	3000 LARGE T&R	Yes	Call TI	Level-1-260C-UNLIM	-40 to 85	HDAH
LMK6DA05184ADLER.B	Active	Production	VSON (DLE) 6	3000 LARGE T&R	Yes	Call TI	Level-1-260C-UNLIM	-40 to 85	HDAH
LMK6DA10000ADLER	Active	Production	VSON (DLE) 6	3000 LARGE T&R	Yes	Call TI	Level-1-260C-UNLIM	-40 to 85	LDA8
LMK6DA10000ADLER.A	Active	Production	VSON (DLE) 6	3000 LARGE T&R	Yes	Call TI	Level-1-260C-UNLIM	-40 to 85	LDA8
LMK6DA10000ADLER.B	Active	Production	VSON (DLE) 6	3000 LARGE T&R	Yes	Call TI	Level-1-260C-UNLIM	-40 to 85	LDA8
LMK6DA10000ADLFR	Active	Production	VSON (DLF) 6	3000 LARGE T&R	Yes	Call TI	Level-1-260C-UNLIM	-40 to 85	LDA8
LMK6DA10000ADLFR.A	Active	Production	VSON (DLF) 6	3000 LARGE T&R	Yes	Call TI	Level-1-260C-UNLIM	-40 to 85	LDA8
LMK6DA10000ADLFR.B	Active	Production	VSON (DLF) 6	3000 LARGE T&R	Yes	Call TI	Level-1-260C-UNLIM	-40 to 85	LDA8
LMK6DA12288ADLER	Active	Production	VSON (DLE) 6	3000 LARGE T&R	Yes	Call TI	Level-1-260C-UNLIM	-40 to 85	HDA4
LMK6DA12288ADLER.A	Active	Production	VSON (DLE) 6	3000 LARGE T&R	Yes	Call TI	Level-1-260C-UNLIM	-40 to 85	HDA4

Orderable part number	Status (1)	Material type (2)	Package Pins	Package qty Carrier	RoHS (3)	Lead finish/ Ball material (4)	MSL rating/ Peak reflow (5)	Op temp (°C)	Part marking (6)
LMK6DA12288ADLER.B	Active	Production	VSON (DLE) 6	3000 LARGE T&R	Yes	Call TI	Level-1-260C-UNLIM	-40 to 85	HDA4
LMK6DA12288ADLFR	Active	Production	VSON (DLF) 6	3000 LARGE T&R	Yes	Call TI	Level-1-260C-UNLIM	-40 to 85	HDA4
LMK6DA12288ADLFR.A	Active	Production	VSON (DLF) 6	3000 LARGE T&R	Yes	Call TI	Level-1-260C-UNLIM	-40 to 85	HDA4
LMK6DA12288ADLFR.B	Active	Production	VSON (DLF) 6	3000 LARGE T&R	Yes	Call TI	Level-1-260C-UNLIM	-40 to 85	HDA4
LMK6DA125000ADLER	Active	Production	VSON (DLE) 6	3000 LARGE T&R	Yes	Call TI	Level-1-260C-UNLIM	-40 to 85	LDA6
LMK6DA125000ADLER.A	Active	Production	VSON (DLE) 6	3000 LARGE T&R	Yes	Call TI	Level-1-260C-UNLIM	-40 to 85	LDA6
LMK6DA125000ADLER.B	Active	Production	VSON (DLE) 6	3000 LARGE T&R	Yes	Call TI	Level-1-260C-UNLIM	-40 to 85	LDA6
LMK6DA12500ADLFR	Active	Production	VSON (DLF) 6	3000 LARGE T&R	Yes	Call TI	Level-1-260C-UNLIM	-40 to 85	LDA6
LMK6DA12500ADLFR.A	Active	Production	VSON (DLF) 6	3000 LARGE T&R	Yes	Call TI	Level-1-260C-UNLIM	-40 to 85	LDA6
LMK6DA12500ADLFR.B	Active	Production	VSON (DLF) 6	3000 LARGE T&R	Yes	Call TI	Level-1-260C-UNLIM	-40 to 85	LDA6
LMK6DA14850ADLFR	Active	Production	VSON (DLF) 6	3000 LARGE T&R	Yes	Call TI	Level-1-260C-UNLIM	-40 to 85	LDA3
LMK6DA14850ADLFR.A	Active	Production	VSON (DLF) 6	3000 LARGE T&R	Yes	Call TI	Level-1-260C-UNLIM	-40 to 85	LDA3
LMK6DA14850ADLFR.B	Active	Production	VSON (DLF) 6	3000 LARGE T&R	Yes	Call TI	Level-1-260C-UNLIM	-40 to 85	LDA3
LMK6DA15552ADLER	Active	Production	VSON (DLE) 6	3000 LARGE T&R	Yes	Call TI	Level-1-260C-UNLIM	-40 to 85	HDA3
LMK6DA15552ADLER.A	Active	Production	VSON (DLE) 6	3000 LARGE T&R	Yes	Call TI	Level-1-260C-UNLIM	-40 to 85	HDA3
LMK6DA15552ADLER.B	Active	Production	VSON (DLE) 6	3000 LARGE T&R	Yes	Call TI	Level-1-260C-UNLIM	-40 to 85	HDA3
LMK6DA15625ADLER	Active	Production	VSON (DLE) 6	3000 LARGE T&R	Yes	Call TI	Level-1-260C-UNLIM	-40 to 85	LDA2
LMK6DA15625ADLER.A	Active	Production	VSON (DLE) 6	3000 LARGE T&R	Yes	Call TI	Level-1-260C-UNLIM	-40 to 85	LDA2
LMK6DA15625ADLER.B	Active	Production	VSON (DLE) 6	3000 LARGE T&R	Yes	Call TI	Level-1-260C-UNLIM	-40 to 85	LDA2
LMK6DA15625ADLFR	Active	Production	VSON (DLF) 6	3000 LARGE T&R	Yes	Call TI	Level-1-260C-UNLIM	-40 to 85	LDA2
LMK6DA15625ADLFR.A	Active	Production	VSON (DLF) 6	3000 LARGE T&R	Yes	Call TI	Level-1-260C-UNLIM	-40 to 85	LDA2
LMK6DA15625ADLFR.B	Active	Production	VSON (DLF) 6	3000 LARGE T&R	Yes	Call TI	Level-1-260C-UNLIM	-40 to 85	LDA2
LMK6DA16113AADLFR	Active	Production	VSON (DLF) 6	3000 LARGE T&R	Yes	Call TI	Level-1-260C-UNLIM	-40 to 85	LDA1
LMK6DA16113AADLFR.A	Active	Production	VSON (DLF) 6	3000 LARGE T&R	Yes	Call TI	Level-1-260C-UNLIM	-40 to 85	LDA1
LMK6DA16113AADLFR.B	Active	Production	VSON (DLF) 6	3000 LARGE T&R	Yes	Call TI	Level-1-260C-UNLIM	-40 to 85	LDA1
LMK6DA20000ADLER	Active	Production	VSON (DLE) 6	3000 LARGE T&R	Yes	Call TI	Level-1-260C-UNLIM	-40 to 85	HDA1
LMK6DA20000ADLER.A	Active	Production	VSON (DLE) 6	3000 LARGE T&R	Yes	Call TI	Level-1-260C-UNLIM	-40 to 85	HDA1
LMK6DA20000ADLER.B	Active	Production	VSON (DLE) 6	3000 LARGE T&R	Yes	Call TI	Level-1-260C-UNLIM	-40 to 85	HDA1
LMK6DA20000ADLFR	Active	Production	VSON (DLF) 6	3000 LARGE T&R	Yes	Call TI	Level-1-260C-UNLIM	-40 to 85	HDA1
LMK6DA20000ADLFR.A	Active	Production	VSON (DLF) 6	3000 LARGE T&R	Yes	Call TI	Level-1-260C-UNLIM	-40 to 85	HDA1
LMK6DA20000ADLFR.B	Active	Production	VSON (DLF) 6	3000 LARGE T&R	Yes	Call TI	Level-1-260C-UNLIM	-40 to 85	HDA1

Orderable part number	Status (1)	Material type (2)	Package Pins	Package qty Carrier	RoHS (3)	Lead finish/ Ball material (4)	MSL rating/ Peak reflow (5)	Op temp (°C)	Part marking (6)
LMK6DA31250ADLFR	Active	Production	VSON (DLF) 6	3000 LARGE T&R	Yes	Call TI	Level-1-260C-UNLIM	-40 to 85	LDA0
LMK6DA31250ADLFR.A	Active	Production	VSON (DLF) 6	3000 LARGE T&R	Yes	Call TI	Level-1-260C-UNLIM	-40 to 85	LDA0
LMK6DA31250ADLFR.B	Active	Production	VSON (DLF) 6	3000 LARGE T&R	Yes	Call TI	Level-1-260C-UNLIM	-40 to 85	LDA0
LMK6DA40000ADLFR	Active	Production	VSON (DLF) 6	3000 LARGE T&R	Yes	Call TI	Level-1-260C-UNLIM	-40 to 85	LDAM
LMK6DA40000ADLFR.A	Active	Production	VSON (DLF) 6	3000 LARGE T&R	Yes	Call TI	Level-1-260C-UNLIM	-40 to 85	LDAM
LMK6DA40000ADLFR.B	Active	Production	VSON (DLF) 6	3000 LARGE T&R	Yes	Call TI	Level-1-260C-UNLIM	-40 to 85	LDAM
LMK6DE026000ADLFR	Active	Production	VSON (DLF) 6	-	Yes	Call TI	Level-1-260C-UNLIM	-40 to 85	LDGF
LMK6DE026000ADLFR.A	Active	Production	VSON (DLF) 6	3000 LARGE T&R	Yes	Call TI	Level-1-260C-UNLIM	-40 to 85	LDGF
LMK6DE026000ADLFR.B	Active	Production	VSON (DLF) 6	3000 LARGE T&R	Yes	Call TI	Level-1-260C-UNLIM	-40 to 85	LDGF
LMK6DE050000ADLER	Active	Production	VSON (DLE) 6	3000 LARGE T&R	Yes	Call TI	Level-1-260C-UNLIM	-40 to 85	LDGB
LMK6DE050000ADLER.A	Active	Production	VSON (DLE) 6	3000 LARGE T&R	Yes	Call TI	Level-1-260C-UNLIM	-40 to 85	LDGB
LMK6DE050000ADLER.B	Active	Production	VSON (DLE) 6	3000 LARGE T&R	Yes	Call TI	Level-1-260C-UNLIM	-40 to 85	LDGB
LMK6DE133330ADLER	Active	Production	VSON (DLE) 6	3000 LARGE T&R	Yes	Call TI	Level-1-260C-UNLIM	-40 to 85	LDG5
LMK6DE133330ADLER.A	Active	Production	VSON (DLE) 6	3000 LARGE T&R	Yes	Call TI	Level-1-260C-UNLIM	-40 to 85	LDG5
LMK6DE133330ADLER.B	Active	Production	VSON (DLE) 6	3000 LARGE T&R	Yes	Call TI	Level-1-260C-UNLIM	-40 to 85	LDG5
LMK6DE156250BDLER	Active	Production	VSON (DLE) 6	3000 LARGE T&R	Yes	Call TI	Level-1-260C-UNLIM	-40 to 85	LD72
LMK6DE156250BDLER.A	Active	Production	VSON (DLE) 6	3000 LARGE T&R	Yes	Call TI	Level-1-260C-UNLIM	-40 to 85	LD72
LMK6DE156250BDLER.B	Active	Production	VSON (DLE) 6	3000 LARGE T&R	Yes	Call TI	Level-1-260C-UNLIM	-40 to 85	LD72
LMK6DE322265ADLFR	Active	Production	VSON (DLF) 6	3000 LARGE T&R	Yes	Call TI	Level-1-260C-UNLIM	-40 to 85	HDGS
LMK6DE322265ADLFR.A	Active	Production	VSON (DLF) 6	3000 LARGE T&R	Yes	Call TI	Level-1-260C-UNLIM	-40 to 85	HDGS
LMK6DE322265ADLFR.B	Active	Production	VSON (DLF) 6	3000 LARGE T&R	Yes	Call TI	Level-1-260C-UNLIM	-40 to 85	HDGS
LMK6DE400000BDLER	Active	Production	VSON (DLE) 6	3000 LARGE T&R	Yes	Call TI	Level-1-260C-UNLIM	-40 to 85	LD7M
LMK6DE400000BDLER.A	Active	Production	VSON (DLE) 6	3000 LARGE T&R	Yes	Call TI	Level-1-260C-UNLIM	-40 to 85	LD7M
LMK6DE400000BDLER.B	Active	Production	VSON (DLE) 6	3000 LARGE T&R	Yes	Call TI	Level-1-260C-UNLIM	-40 to 85	LD7M
LMK6HA10000ADLER	Active	Production	VSON (DLE) 6	3000 LARGE T&R	Yes	Call TI	Level-1-260C-UNLIM	-40 to 85	LHA8
LMK6HA10000ADLER.A	Active	Production	VSON (DLE) 6	3000 LARGE T&R	Yes	Call TI	Level-1-260C-UNLIM	-40 to 85	LHA8
LMK6HA10000ADLER.B	Active	Production	VSON (DLE) 6	3000 LARGE T&R	Yes	Call TI	Level-1-260C-UNLIM	-40 to 85	LHA8
LMK6HA10000ADLFR	Active	Production	VSON (DLF) 6	3000 LARGE T&R	Yes	Call TI	Level-1-260C-UNLIM	-40 to 85	LHA8
LMK6HA10000ADLFR.A	Active	Production	VSON (DLF) 6	3000 LARGE T&R	Yes	Call TI	Level-1-260C-UNLIM	-40 to 85	LHA8
LMK6HA10000ADLFR.B	Active	Production	VSON (DLF) 6	3000 LARGE T&R	Yes	Call TI	Level-1-260C-UNLIM	-40 to 85	LHA8
LMK6HA10000BDLFR	Active	Production	VSON (DLF) 6	3000 LARGE T&R	Yes	Call TI	Level-1-260C-UNLIM	-40 to 85	LH18

Orderable part number	Status (1)	Material type (2)	Package Pins	Package qty Carrier	RoHS (3)	Lead finish/ Ball material (4)	MSL rating/ Peak reflow (5)	Op temp (°C)	Part marking (6)
LMK6HA10000BDLFR.A	Active	Production	VSON (DLF) 6	3000 LARGE T&R	Yes	Call TI	Level-1-260C-UNLIM	-40 to 85	LH18
LMK6HA10000BDLFR.B	Active	Production	VSON (DLF) 6	3000 LARGE T&R	Yes	Call TI	Level-1-260C-UNLIM	-40 to 85	LH18
LMK6HA15625ADLER	Active	Production	VSON (DLE) 6	3000 LARGE T&R	Yes	Call TI	Level-1-260C-UNLIM	-40 to 85	LHA2
LMK6HA15625ADLER.A	Active	Production	VSON (DLE) 6	3000 LARGE T&R	Yes	Call TI	Level-1-260C-UNLIM	-40 to 85	LHA2
LMK6HA15625ADLER.B	Active	Production	VSON (DLE) 6	3000 LARGE T&R	Yes	Call TI	Level-1-260C-UNLIM	-40 to 85	LHA2
LMK6HA40000ADLER	Active	Production	VSON (DLE) 6	3000 LARGE T&R	Yes	Call TI	Level-1-260C-UNLIM	-40 to 85	LHAM
LMK6HA40000ADLER.A	Active	Production	VSON (DLE) 6	3000 LARGE T&R	Yes	Call TI	Level-1-260C-UNLIM	-40 to 85	LHAM
LMK6HA40000ADLER.B	Active	Production	VSON (DLE) 6	3000 LARGE T&R	Yes	Call TI	Level-1-260C-UNLIM	-40 to 85	LHAM
LMK6HE025000ADLER	Active	Production	VSON (DLE) 6	3000 LARGE T&R	Yes	Call TI	Level-1-260C-UNLIM	-40 to 85	LHGG
LMK6HE025000ADLER.A	Active	Production	VSON (DLE) 6	3000 LARGE T&R	Yes	Call TI	Level-1-260C-UNLIM	-40 to 85	LHGG
LMK6HE025000ADLER.B	Active	Production	VSON (DLE) 6	3000 LARGE T&R	Yes	Call TI	Level-1-260C-UNLIM	-40 to 85	LHGG
LMK6HE100000ADLER	Active	Production	VSON (DLE) 6	3000 LARGE T&R	Yes	Call TI	Level-1-260C-UNLIM	-40 to 85	LHG8
LMK6HE100000ADLER.A	Active	Production	VSON (DLE) 6	3000 LARGE T&R	Yes	Call TI	Level-1-260C-UNLIM	-40 to 85	LHG8
LMK6HE100000ADLER.B	Active	Production	VSON (DLE) 6	3000 LARGE T&R	Yes	Call TI	Level-1-260C-UNLIM	-40 to 85	LHG8
LMK6HE156250BDLFR	Active	Production	VSON (DLF) 6	3000 LARGE T&R	Yes	Call TI	Level-1-260C-UNLIM	-40 to 85	LH22
LMK6HE156250BDLFR.A	Active	Production	VSON (DLF) 6	3000 LARGE T&R	Yes	Call TI	Level-1-260C-UNLIM	-40 to 85	LH22
LMK6HE156250BDLFR.B	Active	Production	VSON (DLF) 6	3000 LARGE T&R	Yes	Call TI	Level-1-260C-UNLIM	-40 to 85	LH22
LMK6HE400000BDLER	Active	Production	VSON (DLE) 6	3000 LARGE T&R	Yes	Call TI	Level-1-260C-UNLIM	-40 to 85	LH7M
LMK6HE400000BDLER.A	Active	Production	VSON (DLE) 6	3000 LARGE T&R	Yes	Call TI	Level-1-260C-UNLIM	-40 to 85	LH7M
LMK6HE400000BDLER.B	Active	Production	VSON (DLE) 6	3000 LARGE T&R	Yes	Call TI	Level-1-260C-UNLIM	-40 to 85	LH7M
LMK6HE40000ADLFR	Active	Production	VSON (DLF) 6	3000 LARGE T&R	Yes	Call TI	Level-1-260C-UNLIM	-40 to 85	LHGM
LMK6HE40000ADLFR.A	Active	Production	VSON (DLF) 6	3000 LARGE T&R	Yes	Call TI	Level-1-260C-UNLIM	-40 to 85	LHGM
LMK6HE40000ADLFR.B	Active	Production	VSON (DLF) 6	3000 LARGE T&R	Yes	Call TI	Level-1-260C-UNLIM	-40 to 85	LHGM
LMK6PA15625ADLER	Active	Production	VSON (DLE) 6	3000 LARGE T&R	Yes	Call TI	Level-1-260C-UNLIM	-40 to 85	LPA2
LMK6PA15625ADLER.A	Active	Production	VSON (DLE) 6	3000 LARGE T&R	Yes	Call TI	Level-1-260C-UNLIM	-40 to 85	LPA2
LMK6PA15625ADLER.B	Active	Production	VSON (DLE) 6	3000 LARGE T&R	Yes	Call TI	Level-1-260C-UNLIM	-40 to 85	LPA2
LMK6PA15625ADLFR	Active	Production	VSON (DLF) 6	3000 LARGE T&R	Yes	Call TI	Level-1-260C-UNLIM	-40 to 85	LPA2
LMK6PA15625ADLFR.A	Active	Production	VSON (DLF) 6	3000 LARGE T&R	Yes	Call TI	Level-1-260C-UNLIM	-40 to 85	LPA2
LMK6PA15625ADLFR.B	Active	Production	VSON (DLF) 6	3000 LARGE T&R	Yes	Call TI	Level-1-260C-UNLIM	-40 to 85	LPA2
LMK6PE025000ADLER	Active	Production	VSON (DLE) 6	3000 LARGE T&R	Yes	Call TI	Level-1-260C-UNLIM	-40 to 85	LPGG
LMK6PE025000ADLER.A	Active	Production	VSON (DLE) 6	3000 LARGE T&R	Yes	Call TI	Level-1-260C-UNLIM	-40 to 85	LPGG

Orderable part number	Status (1)	Material type (2)	Package Pins	Package qty Carrier	RoHS (3)	Lead finish/ Ball material (4)	MSL rating/ Peak reflow (5)	Op temp (°C)	Part marking (6)
LMK6PE025000ADLER.B	Active	Production	VSON (DLE) 6	3000 LARGE T&R	Yes	Call TI	Level-1-260C-UNLIM	-40 to 85	LPGG
LMK6PE025000BDLFR	Active	Production	VSON (DLF) 6	3000 LARGE T&R	Yes	Call TI	Level-1-260C-UNLIM	-40 to 85	LP7G
LMK6PE025000BDLFR.A	Active	Production	VSON (DLF) 6	3000 LARGE T&R	Yes	Call TI	Level-1-260C-UNLIM	-40 to 85	LP7G
LMK6PE025000BDLFR.B	Active	Production	VSON (DLF) 6	3000 LARGE T&R	Yes	Call TI	Level-1-260C-UNLIM	-40 to 85	LP7G
LMK6PE050000ADLER	Active	Production	VSON (DLE) 6	3000 LARGE T&R	Yes	Call TI	Level-1-260C-UNLIM	-40 to 85	LPGB
LMK6PE100000ADLER	Active	Production	VSON (DLE) 6	3000 LARGE T&R	Yes	Call TI	Level-1-260C-UNLIM	-40 to 85	LPG8
LMK6PE100000ADLER.A	Active	Production	VSON (DLE) 6	3000 LARGE T&R	Yes	Call TI	Level-1-260C-UNLIM	-40 to 85	LPG8
LMK6PE100000ADLER.B	Active	Production	VSON (DLE) 6	3000 LARGE T&R	Yes	Call TI	Level-1-260C-UNLIM	-40 to 85	LPG8
LMK6PE150000ADLER	Active	Production	VSON (DLE) 6	3000 LARGE T&R	Yes	Call TI	Level-1-260C-UNLIM	-40 to 85	LPGQ
LMK6PE150000ADLER.A	Active	Production	VSON (DLE) 6	3000 LARGE T&R	Yes	Call TI	Level-1-260C-UNLIM	-40 to 85	LPGQ
LMK6PE150000ADLER.B	Active	Production	VSON (DLE) 6	3000 LARGE T&R	Yes	Call TI	Level-1-260C-UNLIM	-40 to 85	LPGQ
LMK6PE161132ADLER	Active	Production	VSON (DLE) 6	3000 LARGE T&R	Yes	Call TI	Level-1-260C-UNLIM	-40 to 85	LPG1
LMK6PE161132ADLER.A	Active	Production	VSON (DLE) 6	3000 LARGE T&R	Yes	Call TI	Level-1-260C-UNLIM	-40 to 85	LPG1
LMK6PE161132ADLER.B	Active	Production	VSON (DLE) 6	3000 LARGE T&R	Yes	Call TI	Level-1-260C-UNLIM	-40 to 85	LPG1

(1) **Status:** For more details on status, see our [product life cycle](#).

(2) **Material type:** When designated, preproduction parts are prototypes/experimental devices, and are not yet approved or released for full production. Testing and final process, including without limitation quality assurance, reliability performance testing, and/or process qualification, may not yet be complete, and this item is subject to further changes or possible discontinuation. If available for ordering, purchases will be subject to an additional waiver at checkout, and are intended for early internal evaluation purposes only. These items are sold without warranties of any kind.

(3) **RoHS values:** Yes, No, RoHS Exempt. See the [TI RoHS Statement](#) for additional information and value definition.

(4) **Lead finish/Ball material:** Parts may have multiple material finish options. Finish options are separated by a vertical ruled line. Lead finish/Ball material values may wrap to two lines if the finish value exceeds the maximum column width.

(5) **MSL rating/Peak reflow:** The moisture sensitivity level ratings and peak solder (reflow) temperatures. In the event that a part has multiple moisture sensitivity ratings, only the lowest level per JEDEC standards is shown. Refer to the shipping label for the actual reflow temperature that will be used to mount the part to the printed circuit board.

(6) **Part marking:** There may be an additional marking, which relates to the logo, the lot trace code information, or the environmental category of the part.

Multiple part markings will be inside parentheses. Only one part marking contained in parentheses and separated by a "-" will appear on a part. If a line is indented then it is a continuation of the previous line and the two combined represent the entire part marking for that device.

Important Information and Disclaimer: The information provided on this page represents TI's knowledge and belief as of the date that it is provided. TI bases its knowledge and belief on information provided by third parties, and makes no representation or warranty as to the accuracy of such information. Efforts are underway to better integrate information from third parties. TI has taken and continues to take reasonable steps to provide representative and accurate information but may not have conducted destructive testing or chemical analysis on incoming materials and chemicals. TI and TI suppliers consider certain information to be proprietary, and thus CAS numbers and other limited information may not be available for release.

In no event shall TI's liability arising out of such information exceed the total purchase price of the TI part(s) at issue in this document sold by TI to Customer on an annual basis.

TAPE AND REEL INFORMATION



QUADRANT ASSIGNMENTS FOR PIN 1 ORIENTATION IN TAPE



*All dimensions are nominal

Device	Package Type	Package Drawing	Pins	SPQ	Reel Diameter (mm)	Reel Width W1 (mm)	A0 (mm)	B0 (mm)	K0 (mm)	P1 (mm)	W (mm)	Pin1 Quadrant
LMK6CA026214DDLFR	VSON	DLF	4	3000	180.0	8.4	2.25	2.8	1.1	4.0	8.0	Q1
LMK6CA032768DDLFR	VSON	DLF	4	3000	180.0	8.4	2.25	2.8	1.1	4.0	8.0	Q1
LMK6CA048000CDLFR	VSON	DLF	4	3000	180.0	8.4	2.25	2.8	1.1	4.0	8.0	Q1
LMK6CE001000DDLFR	VSON	DLE	4	3000	330.0	12.4	2.8	3.5	1.2	4.0	12.0	Q1
LMK6CE001000DDLFR	VSON	DLF	4	3000	180.0	8.4	2.25	2.8	1.1	4.0	8.0	Q1
LMK6CE001200CDLFR	VSON	DLF	4	3000	180.0	8.4	2.25	2.8	1.1	4.0	8.0	Q1
LMK6CE008000CDLFR	VSON	DLF	4	3000	180.0	8.4	2.25	2.8	1.1	4.0	8.0	Q1
LMK6CE012288CDLFR	VSON	DLF	4	3000	180.0	8.4	2.25	2.8	1.1	4.0	8.0	Q1
LMK6CE016000CDLER	VSON	DLE	4	3000	330.0	12.4	2.8	3.5	1.2	4.0	12.0	Q1
LMK6CE019200CDLER	VSON	DLE	4	3000	330.0	12.4	2.8	3.5	1.2	4.0	12.0	Q1
LMK6CE02000CDLER	VSON	DLE	4	3000	330.0	12.4	2.8	3.5	1.2	4.0	12.0	Q1
LMK6CE02000CDLFR	VSON	DLF	4	3000	180.0	8.4	2.25	2.8	1.1	4.0	8.0	Q1
LMK6CE02400CDLER	VSON	DLE	4	3000	330.0	12.4	2.8	3.5	1.2	4.0	12.0	Q1
LMK6CE02400CDLFR	VSON	DLF	4	3000	180.0	8.4	2.25	2.8	1.1	4.0	8.0	Q1
LMK6CE024576CDLFR	VSON	DLF	4	3000	180.0	8.4	2.25	2.8	1.1	4.0	8.0	Q1
LMK6CE02500CDLER	VSON	DLE	4	3000	330.0	12.4	2.8	3.5	1.2	4.0	12.0	Q1

Device	Package Type	Package Drawing	Pins	SPQ	Reel Diameter (mm)	Reel Width W1 (mm)	A0 (mm)	B0 (mm)	K0 (mm)	P1 (mm)	W (mm)	Pin1 Quadrant
LMK6CE02500CDLFR	VSON	DLF	4	3000	180.0	8.4	2.25	2.8	1.1	4.0	8.0	Q1
LMK6CE02500DDLFR	VSON	DLE	4	3000	330.0	12.4	2.8	3.5	1.2	4.0	12.0	Q1
LMK6CE02500DDLFR	VSON	DLF	4	3000	180.0	8.4	2.25	2.8	1.1	4.0	8.0	Q1
LMK6CE027000CDLER	VSON	DLE	4	3000	330.0	12.4	2.8	3.5	1.2	4.0	12.0	Q1
LMK6CE027000CDLFR	VSON	DLF	4	3000	180.0	8.4	2.25	2.8	1.1	4.0	8.0	Q1
LMK6CE028125CDLFR	VSON	DLF	4	3000	180.0	8.4	2.25	2.8	1.1	4.0	8.0	Q1
LMK6CE030000CDLFR	VSON	DLF	4	3000	180.0	8.4	2.25	2.8	1.1	4.0	8.0	Q1
LMK6CE03333DDLFR	VSON	DLF	4	3000	180.0	8.4	2.25	2.8	1.1	4.0	8.0	Q1
LMK6CE03333ADLER	VSON	DLE	4	3000	330.0	12.4	2.8	3.5	1.2	4.0	12.0	Q1
LMK6CE03333CDLER	VSON	DLE	4	3000	330.0	12.4	2.8	3.5	1.2	4.0	12.0	Q1
LMK6CE033550CDLER	VSON	DLE	4	3000	330.0	12.4	2.8	3.5	1.2	4.0	12.0	Q1
LMK6CE04000CDLFR	VSON	DLF	4	3000	180.0	8.4	2.25	2.8	1.1	4.0	8.0	Q1
LMK6CE048000CDLER	VSON	DLE	4	3000	330.0	12.4	2.8	3.5	1.2	4.0	12.0	Q1
LMK6CE048000CDLFR	VSON	DLF	4	3000	180.0	8.4	2.25	2.8	1.1	4.0	8.0	Q1
LMK6CE04800DDLFR	VSON	DLF	4	3000	180.0	8.4	2.25	2.8	1.1	4.0	8.0	Q1
LMK6CE049152CDLFR	VSON	DLF	4	3000	180.0	8.4	2.25	2.8	1.1	4.0	8.0	Q1
LMK6CE050000DDLFR	VSON	DLF	4	3000	180.0	8.4	2.25	2.8	1.1	4.0	8.0	Q1
LMK6CE05000CDLER	VSON	DLE	4	3000	330.0	12.4	2.8	3.5	1.2	4.0	12.0	Q1
LMK6CE05000CDLFR	VSON	DLF	4	3000	180.0	8.4	2.25	2.8	1.1	4.0	8.0	Q1
LMK6CE05000DDLFR	VSON	DLE	4	3000	330.0	12.4	2.8	3.5	1.2	4.0	12.0	Q1
LMK6CE05000DDLFR	VSON	DLF	4	3000	180.0	8.4	2.25	2.8	1.1	4.0	8.0	Q1
LMK6CE06666CDLER	VSON	DLE	4	3000	330.0	12.4	2.8	3.5	1.2	4.0	12.0	Q1
LMK6CE07425DDLFR	VSON	DLF	4	3000	180.0	8.4	2.25	2.8	1.1	4.0	8.0	Q1
LMK6CE10000CDLER	VSON	DLE	4	3000	330.0	12.4	2.8	3.5	1.2	4.0	12.0	Q1
LMK6CE10000CDLFR	VSON	DLF	4	3000	180.0	8.4	2.25	2.8	1.1	4.0	8.0	Q1
LMK6CE10000DDLFR	VSON	DLE	4	3000	330.0	12.4	2.8	3.5	1.2	4.0	12.0	Q1
LMK6CE10000DDLFR	VSON	DLF	4	3000	180.0	8.4	2.25	2.8	1.1	4.0	8.0	Q1
LMK6CE10800DDLFR	VSON	DLF	4	3000	180.0	8.4	2.25	2.8	1.1	4.0	8.0	Q1
LMK6CE125000DDLFR	VSON	DLE	4	3000	330.0	12.4	2.8	3.5	1.2	4.0	12.0	Q1
LMK6CE12500CDLER	VSON	DLE	4	3000	330.0	12.4	2.8	3.5	1.2	4.0	12.0	Q1
LMK6CE15625DDLFR	VSON	DLF	4	3000	180.0	8.4	2.25	2.8	1.1	4.0	8.0	Q1
LMK6DA02500ADLFR	VSON	DLF	6	3000	180.0	8.4	2.25	2.8	1.1	4.0	8.0	Q1
LMK6DA05184ADLER	VSON	DLE	6	3000	330.0	12.4	2.8	3.5	1.2	4.0	12.0	Q1
LMK6DA10000ADLER	VSON	DLE	6	3000	330.0	12.4	2.8	3.5	1.2	4.0	12.0	Q1
LMK6DA10000ADLFR	VSON	DLF	6	3000	180.0	8.4	2.25	2.8	1.1	4.0	8.0	Q1
LMK6DA12288ADLER	VSON	DLE	6	3000	330.0	12.4	2.8	3.5	1.2	4.0	12.0	Q1
LMK6DA12288ADLFR	VSON	DLF	6	3000	180.0	8.4	2.25	2.8	1.1	4.0	8.0	Q1
LMK6DA125000ADLER	VSON	DLE	6	3000	330.0	12.4	2.8	3.5	1.2	4.0	12.0	Q1
LMK6DA12500ADLFR	VSON	DLF	6	3000	180.0	8.4	2.25	2.8	1.1	4.0	8.0	Q1
LMK6DA14850ADLFR	VSON	DLF	6	3000	180.0	8.4	2.25	2.8	1.1	4.0	8.0	Q1
LMK6DA15552ADLER	VSON	DLE	6	3000	330.0	12.4	2.8	3.5	1.2	4.0	12.0	Q1

Device	Package Type	Package Drawing	Pins	SPQ	Reel Diameter (mm)	Reel Width W1 (mm)	A0 (mm)	B0 (mm)	K0 (mm)	P1 (mm)	W (mm)	Pin1 Quadrant
LMK6DA15625ADLER	VSON	DLE	6	3000	330.0	12.4	2.8	3.5	1.2	4.0	12.0	Q1
LMK6DA15625ADLFR	VSON	DLF	6	3000	180.0	8.4	2.25	2.8	1.1	4.0	8.0	Q1
LMK6DA16113AADLFR	VSON	DLF	6	3000	180.0	8.4	2.25	2.8	1.1	4.0	8.0	Q1
LMK6DA20000ADLER	VSON	DLE	6	3000	330.0	12.4	2.8	3.5	1.2	4.0	12.0	Q1
LMK6DA20000ADLFR	VSON	DLF	6	3000	180.0	8.4	2.25	2.8	1.1	4.0	8.0	Q1
LMK6DA31250ADLFR	VSON	DLF	6	3000	180.0	8.4	2.25	2.8	1.1	4.0	8.0	Q1
LMK6DA40000ADLFR	VSON	DLF	6	3000	180.0	8.4	2.25	2.8	1.1	4.0	8.0	Q1
LMK6DE026000ADLFR	VSON	DLF	6	0	180.0	8.4	2.25	2.8	1.1	4.0	8.0	Q1
LMK6DE050000ADLER	VSON	DLE	6	3000	330.0	12.4	2.8	3.5	1.2	4.0	12.0	Q1
LMK6DE133330ADLER	VSON	DLE	6	3000	330.0	12.4	2.8	3.5	1.2	4.0	12.0	Q1
LMK6DE156250BDLER	VSON	DLE	6	3000	330.0	12.4	2.8	3.5	1.2	4.0	12.0	Q1
LMK6DE322265ADLFR	VSON	DLF	6	3000	180.0	8.4	2.25	2.8	1.1	4.0	8.0	Q1
LMK6DE400000BDLER	VSON	DLE	6	3000	330.0	12.4	2.8	3.5	1.2	4.0	12.0	Q1
LMK6HA10000ADLER	VSON	DLE	6	3000	330.0	12.4	2.8	3.5	1.2	4.0	12.0	Q1
LMK6HA10000ADLFR	VSON	DLF	6	3000	180.0	8.4	2.25	2.8	1.1	4.0	8.0	Q1
LMK6HA10000BDLFR	VSON	DLF	6	3000	180.0	8.4	2.25	2.8	1.1	4.0	8.0	Q1
LMK6HA15625ADLER	VSON	DLE	6	3000	330.0	12.4	2.8	3.5	1.2	4.0	12.0	Q1
LMK6HA40000ADLER	VSON	DLE	6	3000	330.0	12.4	2.8	3.5	1.2	4.0	12.0	Q1
LMK6HE025000ADLER	VSON	DLE	6	3000	330.0	12.4	2.8	3.5	1.2	4.0	12.0	Q1
LMK6HE100000ADLER	VSON	DLE	6	3000	330.0	12.4	2.8	3.5	1.2	4.0	12.0	Q1
LMK6HE156250BDLFR	VSON	DLF	6	3000	180.0	8.4	2.25	2.8	1.1	4.0	8.0	Q1
LMK6HE400000BDLER	VSON	DLE	6	3000	330.0	12.4	2.8	3.5	1.2	4.0	12.0	Q1
LMK6HE40000ADLFR	VSON	DLF	6	3000	180.0	8.4	2.25	2.8	1.1	4.0	8.0	Q1
LMK6PA15625ADLER	VSON	DLE	6	3000	330.0	12.4	2.8	3.5	1.2	4.0	12.0	Q1
LMK6PA15625ADLFR	VSON	DLF	6	3000	180.0	8.4	2.25	2.8	1.1	4.0	8.0	Q1
LMK6PE025000ADLER	VSON	DLE	6	3000	330.0	12.4	2.8	3.5	1.2	4.0	12.0	Q1
LMK6PE025000BDLFR	VSON	DLF	6	3000	180.0	8.4	2.25	2.8	1.1	4.0	8.0	Q1
LMK6PE050000ADLER	VSON	DLE	6	3000	330.0	12.4	2.8	3.5	1.2	4.0	12.0	Q1
LMK6PE100000ADLER	VSON	DLE	6	3000	330.0	12.4	2.8	3.5	1.2	4.0	12.0	Q1
LMK6PE150000ADLER	VSON	DLE	6	3000	330.0	12.4	2.8	3.5	1.2	4.0	12.0	Q1
LMK6PE161132ADLER	VSON	DLE	6	3000	330.0	12.4	2.8	3.5	1.2	4.0	12.0	Q1

TAPE AND REEL BOX DIMENSIONS

*All dimensions are nominal

Device	Package Type	Package Drawing	Pins	SPQ	Length (mm)	Width (mm)	Height (mm)
LMK6CA026214DDLFR	VSON	DLF	4	3000	182.0	182.0	20.0
LMK6CA032768DDLFR	VSON	DLF	4	3000	182.0	182.0	20.0
LMK6CA048000CDLFR	VSON	DLF	4	3000	182.0	182.0	20.0
LMK6CE001000DDLFR	VSON	DLE	4	3000	367.0	367.0	35.0
LMK6CE001000DDLFR	VSON	DLF	4	3000	182.0	182.0	20.0
LMK6CE001200CDLFR	VSON	DLF	4	3000	182.0	182.0	20.0
LMK6CE008000CDLFR	VSON	DLF	4	3000	182.0	182.0	20.0
LMK6CE012288CDLFR	VSON	DLF	4	3000	182.0	182.0	20.0
LMK6CE016000CDLER	VSON	DLE	4	3000	367.0	367.0	35.0
LMK6CE019200CDLER	VSON	DLE	4	3000	367.0	367.0	35.0
LMK6CE02000CDLER	VSON	DLE	4	3000	367.0	367.0	35.0
LMK6CE02000CDLFR	VSON	DLF	4	3000	182.0	182.0	20.0
LMK6CE02400CDLER	VSON	DLE	4	3000	367.0	367.0	35.0
LMK6CE02400CDLFR	VSON	DLF	4	3000	182.0	182.0	20.0
LMK6CE024576CDLFR	VSON	DLF	4	3000	182.0	182.0	20.0
LMK6CE02500CDLER	VSON	DLE	4	3000	367.0	367.0	35.0
LMK6CE02500CDLFR	VSON	DLF	4	3000	182.0	182.0	20.0
LMK6CE02500DDLFR	VSON	DLE	4	3000	367.0	367.0	35.0

Device	Package Type	Package Drawing	Pins	SPQ	Length (mm)	Width (mm)	Height (mm)
LMK6CE02500DDLFR	VSON	DLF	4	3000	182.0	182.0	20.0
LMK6CE027000CDLER	VSON	DLE	4	3000	367.0	367.0	35.0
LMK6CE027000CDLFR	VSON	DLF	4	3000	182.0	182.0	20.0
LMK6CE028125CDLFR	VSON	DLF	4	3000	182.0	182.0	20.0
LMK6CE030000CDLFR	VSON	DLF	4	3000	182.0	182.0	20.0
LMK6CE033333DDLFR	VSON	DLF	4	3000	182.0	182.0	20.0
LMK6CE033333ADLER	VSON	DLE	4	3000	367.0	367.0	35.0
LMK6CE033333CDLER	VSON	DLE	4	3000	346.0	346.0	33.0
LMK6CE033550CDLER	VSON	DLE	4	3000	367.0	367.0	35.0
LMK6CE040000CDLFR	VSON	DLF	4	3000	182.0	182.0	20.0
LMK6CE048000CDLER	VSON	DLE	4	3000	367.0	367.0	35.0
LMK6CE048000CDLFR	VSON	DLF	4	3000	182.0	182.0	20.0
LMK6CE048000DDLFR	VSON	DLF	4	3000	182.0	182.0	20.0
LMK6CE049152CDLFR	VSON	DLF	4	3000	182.0	182.0	20.0
LMK6CE050000DDLFR	VSON	DLF	4	3000	182.0	182.0	20.0
LMK6CE050000CDLER	VSON	DLE	4	3000	367.0	367.0	35.0
LMK6CE050000CDLFR	VSON	DLF	4	3000	182.0	182.0	20.0
LMK6CE050000DDLER	VSON	DLE	4	3000	367.0	367.0	35.0
LMK6CE050000DDLFR	VSON	DLF	4	3000	182.0	182.0	20.0
LMK6CE066666CDLER	VSON	DLE	4	3000	367.0	367.0	35.0
LMK6CE07425DDLFR	VSON	DLF	4	3000	182.0	182.0	20.0
LMK6CE10000CDLER	VSON	DLE	4	3000	367.0	367.0	35.0
LMK6CE10000CDLFR	VSON	DLF	4	3000	182.0	182.0	20.0
LMK6CE10000DDLER	VSON	DLE	4	3000	367.0	367.0	35.0
LMK6CE10000DDLFR	VSON	DLF	4	3000	182.0	182.0	20.0
LMK6CE10800DDLFR	VSON	DLF	4	3000	182.0	182.0	20.0
LMK6CE125000DDLER	VSON	DLE	4	3000	367.0	367.0	35.0
LMK6CE125000CDLER	VSON	DLE	4	3000	367.0	367.0	35.0
LMK6CE15625DDLFR	VSON	DLF	4	3000	182.0	182.0	20.0
LMK6DA02500ADLFR	VSON	DLF	6	3000	182.0	182.0	20.0
LMK6DA05184ADLER	VSON	DLE	6	3000	346.0	346.0	33.0
LMK6DA10000ADLER	VSON	DLE	6	3000	367.0	367.0	35.0
LMK6DA10000ADLFR	VSON	DLF	6	3000	182.0	182.0	20.0
LMK6DA12288ADLER	VSON	DLE	6	3000	346.0	346.0	33.0
LMK6DA12288ADLFR	VSON	DLF	6	3000	182.0	182.0	20.0
LMK6DA125000ADLER	VSON	DLE	6	3000	367.0	367.0	35.0
LMK6DA125000ADLFR	VSON	DLF	6	3000	182.0	182.0	20.0
LMK6DA14850ADLFR	VSON	DLF	6	3000	182.0	182.0	20.0
LMK6DA15552ADLER	VSON	DLE	6	3000	346.0	346.0	33.0
LMK6DA15625ADLER	VSON	DLE	6	3000	367.0	367.0	35.0
LMK6DA15625ADLFR	VSON	DLF	6	3000	182.0	182.0	20.0
LMK6DA16113AADLFR	VSON	DLF	6	3000	182.0	182.0	20.0
LMK6DA20000ADLER	VSON	DLE	6	3000	346.0	346.0	33.0

Device	Package Type	Package Drawing	Pins	SPQ	Length (mm)	Width (mm)	Height (mm)
LMK6DA20000ADLFR	VSON	DLF	6	3000	182.0	182.0	20.0
LMK6DA31250ADLFR	VSON	DLF	6	3000	182.0	182.0	20.0
LMK6DA40000ADLFR	VSON	DLF	6	3000	182.0	182.0	20.0
LMK6DE026000ADLFR	VSON	DLF	6	0	182.0	182.0	20.0
LMK6DE050000ADLER	VSON	DLE	6	3000	367.0	367.0	35.0
LMK6DE133330ADLER	VSON	DLE	6	3000	367.0	367.0	35.0
LMK6DE156250BDLER	VSON	DLE	6	3000	367.0	367.0	35.0
LMK6DE322265ADLFR	VSON	DLF	6	3000	182.0	182.0	20.0
LMK6DE400000BDLER	VSON	DLE	6	3000	367.0	367.0	35.0
LMK6HA10000ADLER	VSON	DLE	6	3000	346.0	346.0	33.0
LMK6HA10000ADLFR	VSON	DLF	6	3000	182.0	182.0	20.0
LMK6HA10000BDLFR	VSON	DLF	6	3000	182.0	182.0	20.0
LMK6HA15625ADLER	VSON	DLE	6	3000	367.0	367.0	35.0
LMK6HA40000ADLER	VSON	DLE	6	3000	367.0	367.0	35.0
LMK6HE025000ADLER	VSON	DLE	6	3000	367.0	367.0	35.0
LMK6HE100000ADLER	VSON	DLE	6	3000	367.0	367.0	35.0
LMK6HE156250BDLFR	VSON	DLF	6	3000	182.0	182.0	20.0
LMK6HE400000BDLER	VSON	DLE	6	3000	367.0	367.0	35.0
LMK6HE40000ADLFR	VSON	DLF	6	3000	182.0	182.0	20.0
LMK6PA15625ADLER	VSON	DLE	6	3000	346.0	346.0	33.0
LMK6PA15625ADLFR	VSON	DLF	6	3000	182.0	182.0	20.0
LMK6PE025000ADLER	VSON	DLE	6	3000	367.0	367.0	35.0
LMK6PE025000BDLFR	VSON	DLF	6	3000	182.0	182.0	20.0
LMK6PE050000ADLER	VSON	DLE	6	3000	367.0	367.0	35.0
LMK6PE100000ADLER	VSON	DLE	6	3000	367.0	367.0	35.0
LMK6PE150000ADLER	VSON	DLE	6	3000	367.0	367.0	35.0
LMK6PE161132ADLER	VSON	DLE	6	3000	367.0	367.0	35.0

GENERIC PACKAGE VIEW

DLE 6

VSON - 1 mm max height

2.5 x 3.2, multiple pitch

PLASTIC SMALL OUTLINE - NO LEAD

This image is a representation of the package family, actual package may vary.
Refer to the product data sheet for package details.

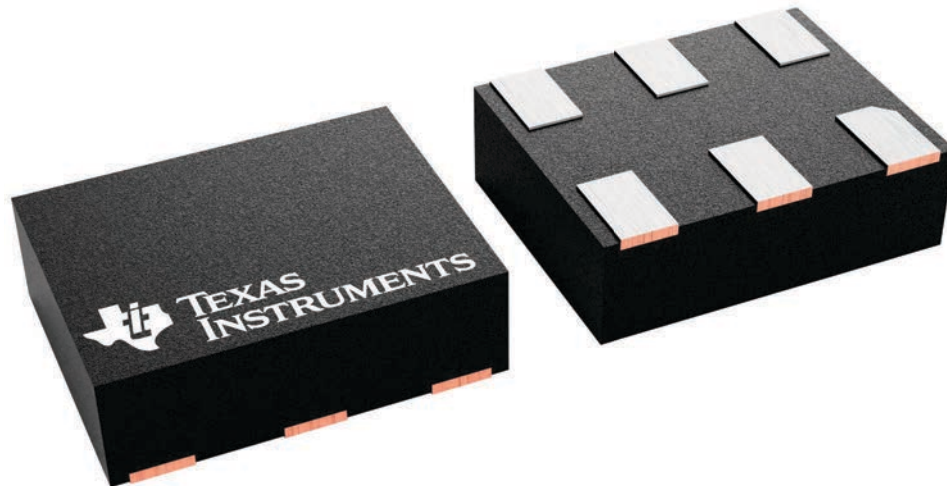

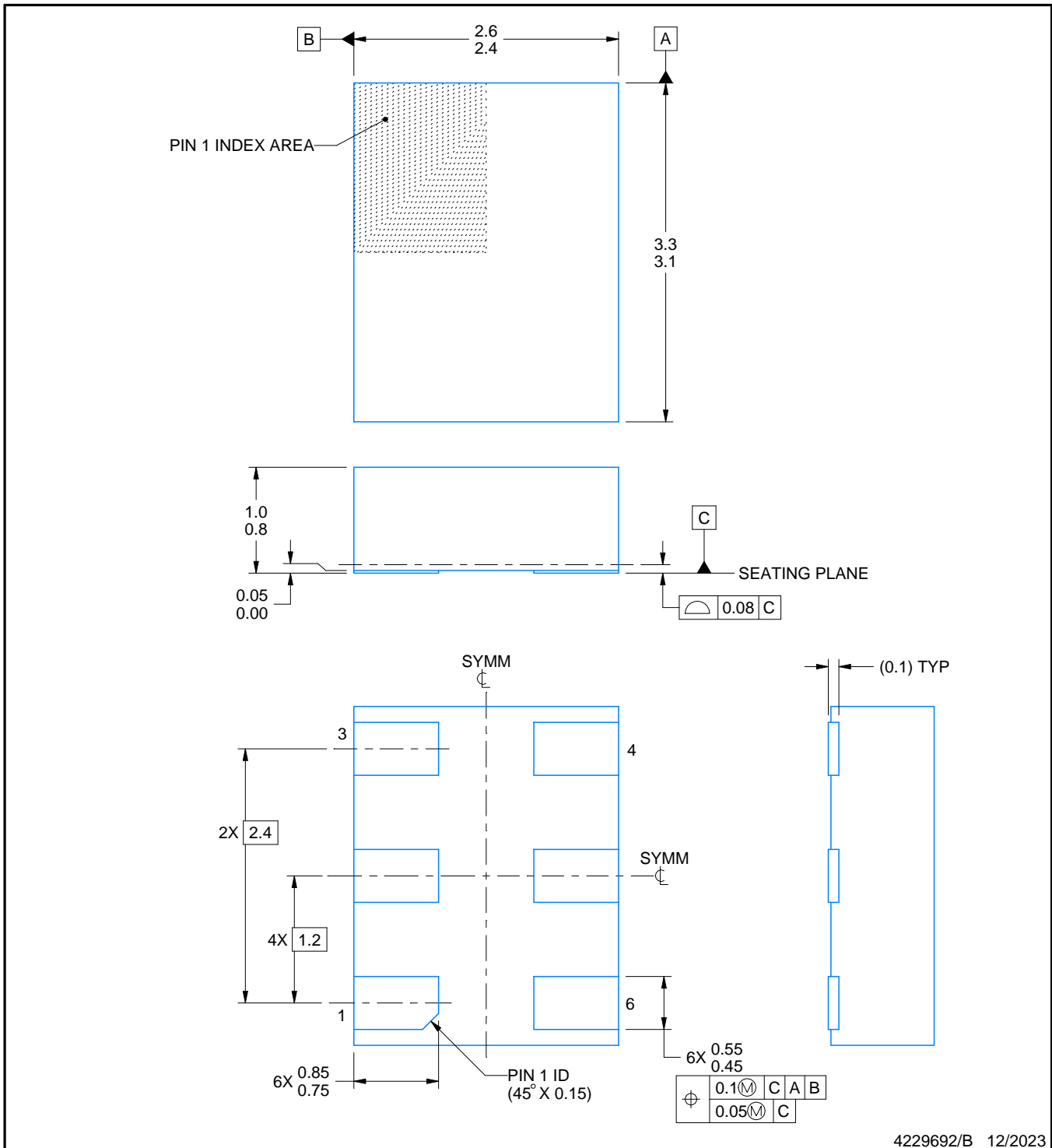
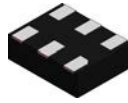

4229692/B 12/2023

NOTES:

1. All linear dimensions are in millimeters. Any dimensions in parenthesis are for reference only. Dimensioning and tolerancing per ASME Y14.5M.
2. This drawing is subject to change without notice.

EXAMPLE BOARD LAYOUT

DLE0006B

VSON - 1 mm max height

PLASTIC SMALL OUTLINE - NO LEAD

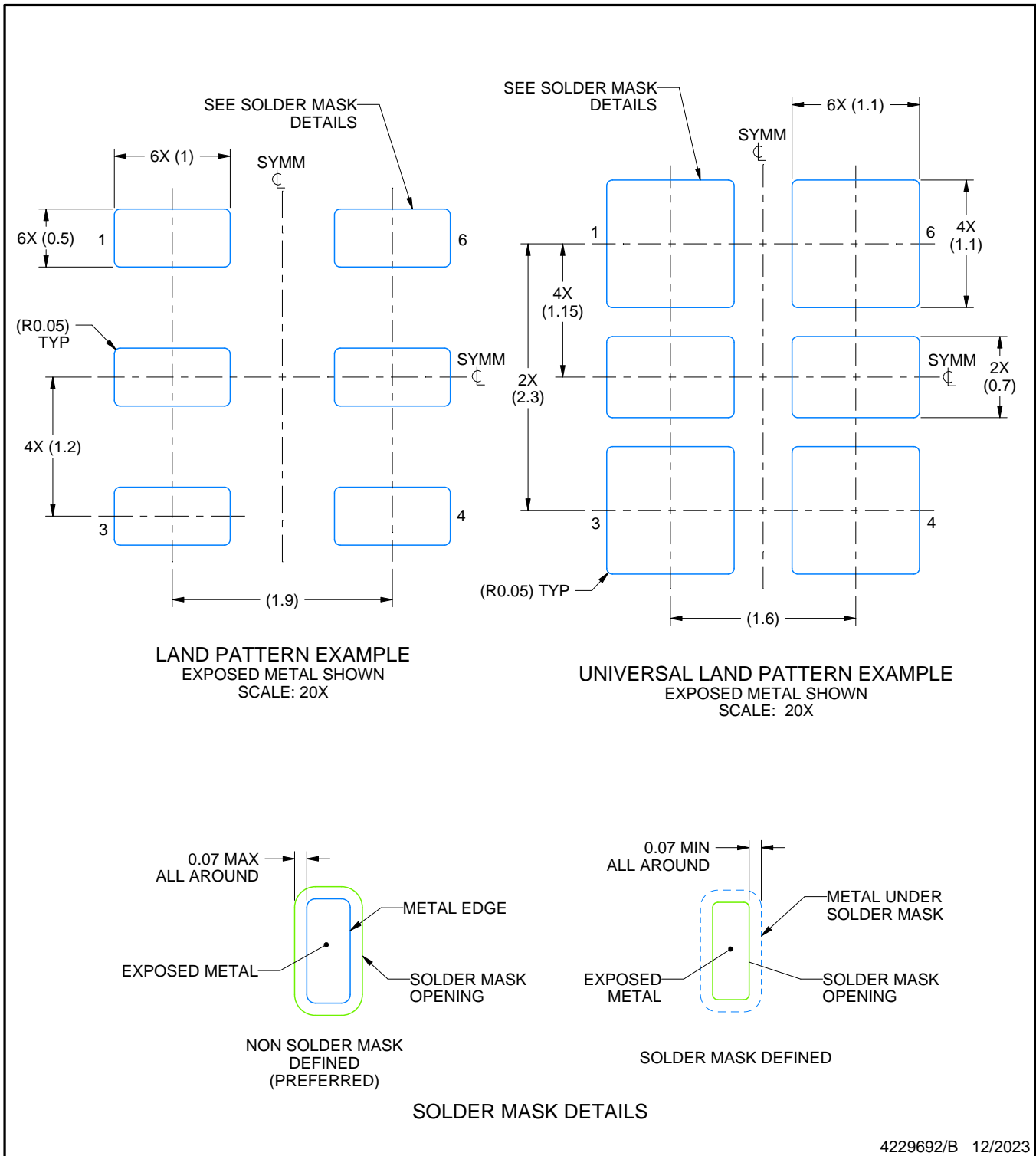

4229692/B 12/2023

NOTES: (continued)

3. For more information, see Texas Instruments literature number SLUA271 (www.ti.com/lit/slua271).

EXAMPLE STENCIL DESIGN

DLE0006B

VSON - 1 mm max height

PLASTIC SMALL OUTLINE - NO LEAD

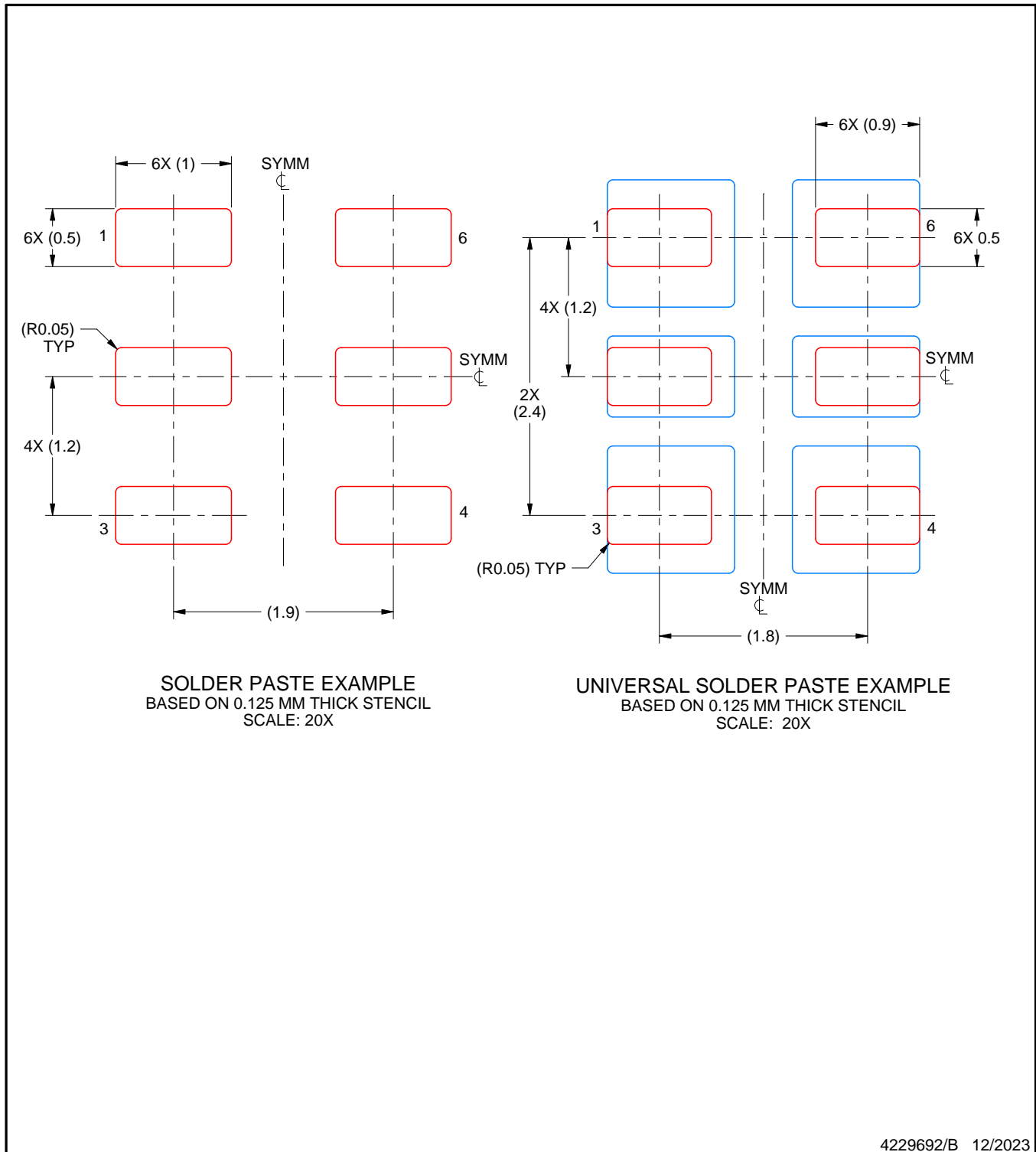

NOTES: (continued)

4. Laser cutting apertures with trapezoidal walls and rounded corners may offer better paste release. IPC-7525 may have alternate design recommendations.

GENERIC PACKAGE VIEW

DLF 6

VSON - 1 mm max height

2 x 2.5, multiple pitch

PLASTIC SMALL OUTLINE - NO LEAD

This image is a representation of the package family, actual package may vary.
Refer to the product data sheet for package details.

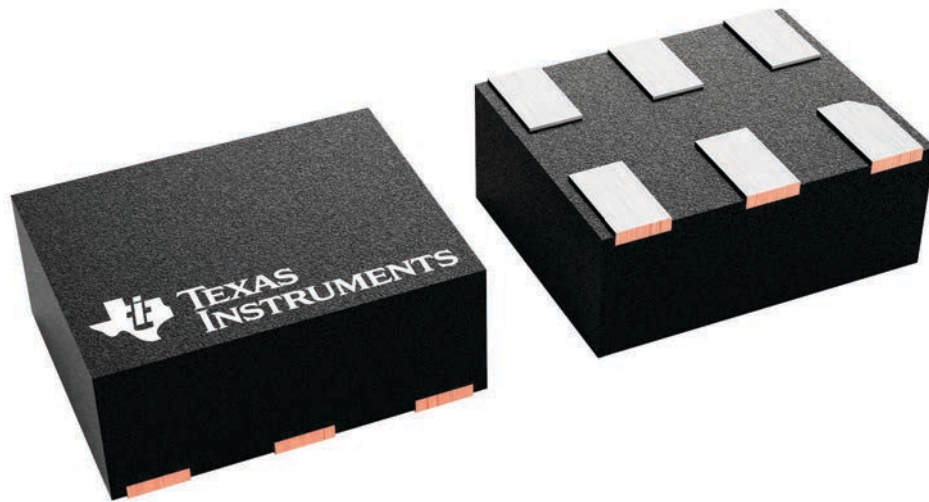

4229715/A

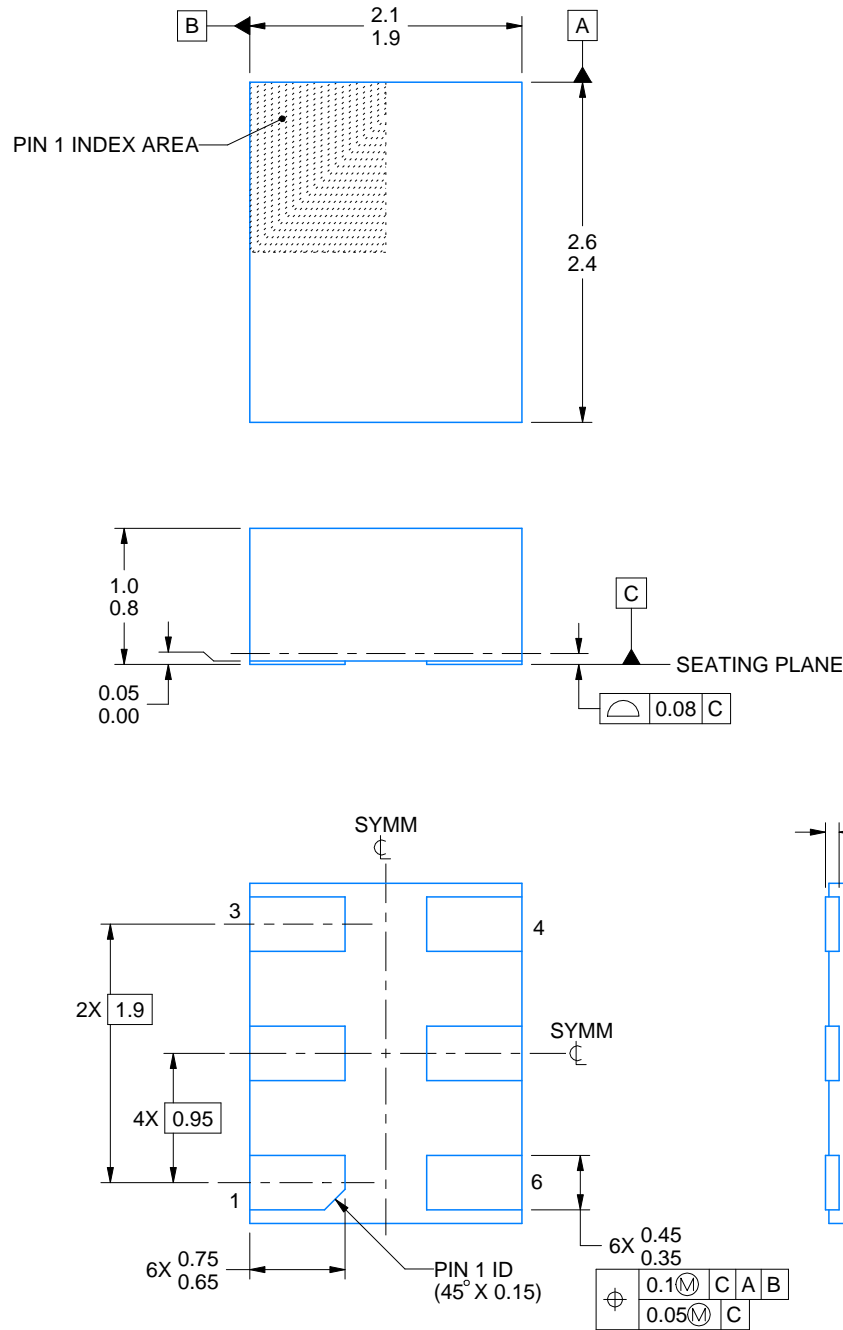
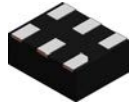

4229693/B 12/2023

NOTES:

1. All linear dimensions are in millimeters. Any dimensions in parenthesis are for reference only. Dimensioning and tolerancing per ASME Y14.5M.
2. This drawing is subject to change without notice.

EXAMPLE BOARD LAYOUT

DLF0006B

VSON - 1 mm max height

PLASTIC SMALL OUTLINE - NO LEAD

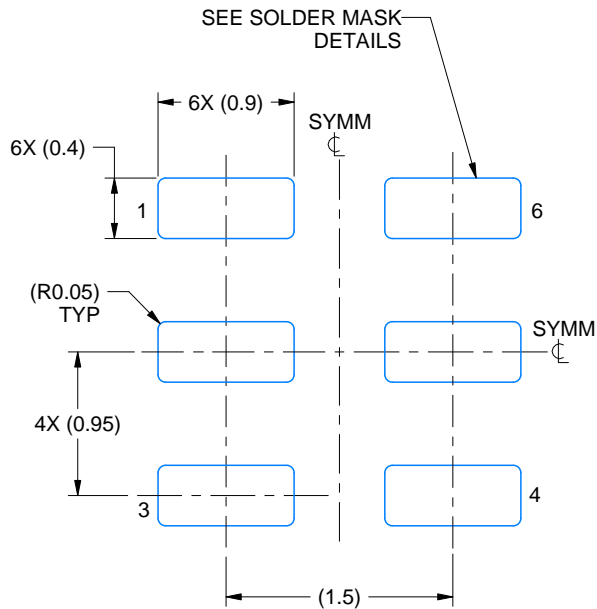

LAND PATTERN EXAMPLE
EXPOSED METAL SHOWN
SCALE: 20X

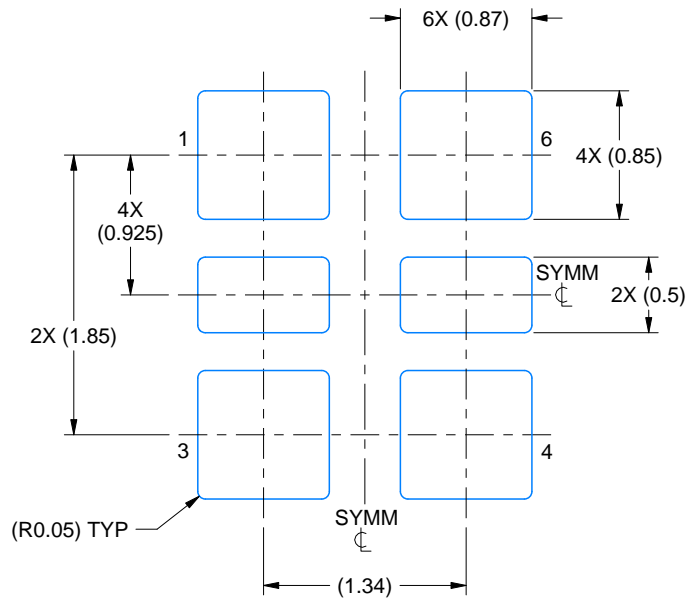

UNIVERSAL LAND PATTERN EXAMPLE
EXPOSED METAL SHOWN
SCALE: 20X

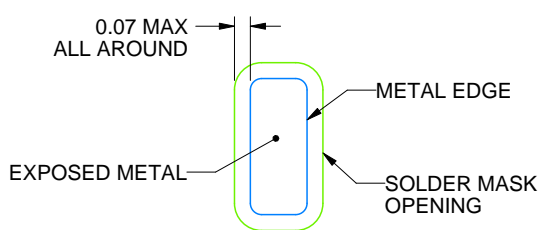

NON SOLDER MASK DEFINED (PREFERRED)

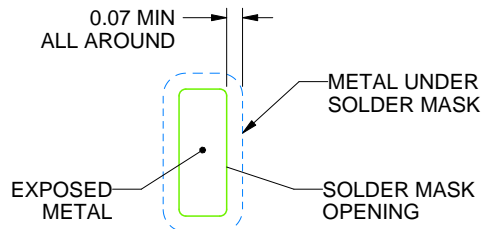

SOLDER MASK DEFINED

SOLDER MASK DETAILS

4229693/B 12/2023

NOTES: (continued)

3. For more information, see Texas Instruments literature number SLUA271 (www.ti.com/lit/slua271).

EXAMPLE STENCIL DESIGN

DLF0006B

VSON - 1 mm max height

PLASTIC SMALL OUTLINE - NO LEAD

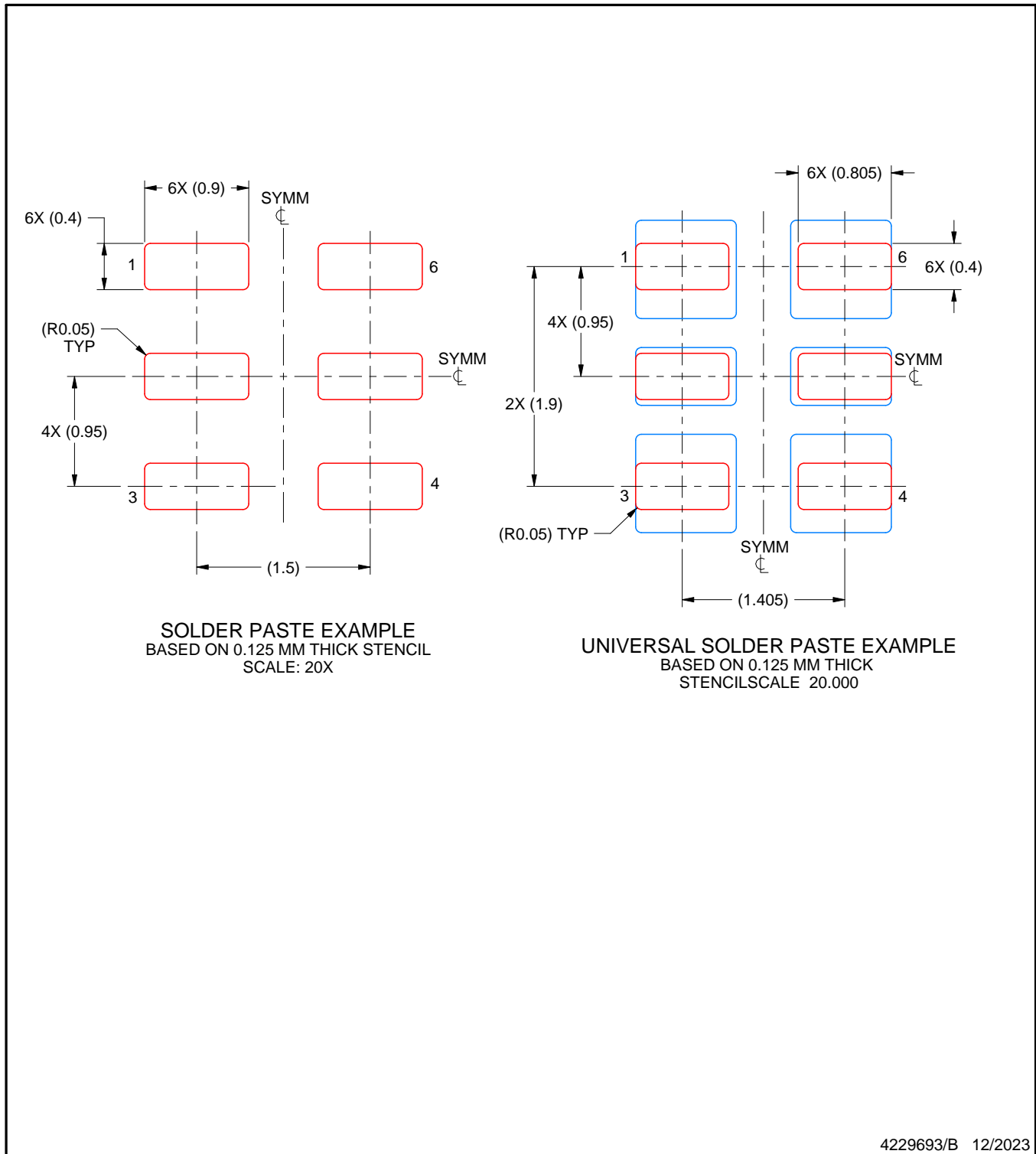

4229693/B 12/2023

NOTES: (continued)

4. Laser cutting apertures with trapezoidal walls and rounded corners may offer better paste release. IPC-7525 may have alternate design recommendations.

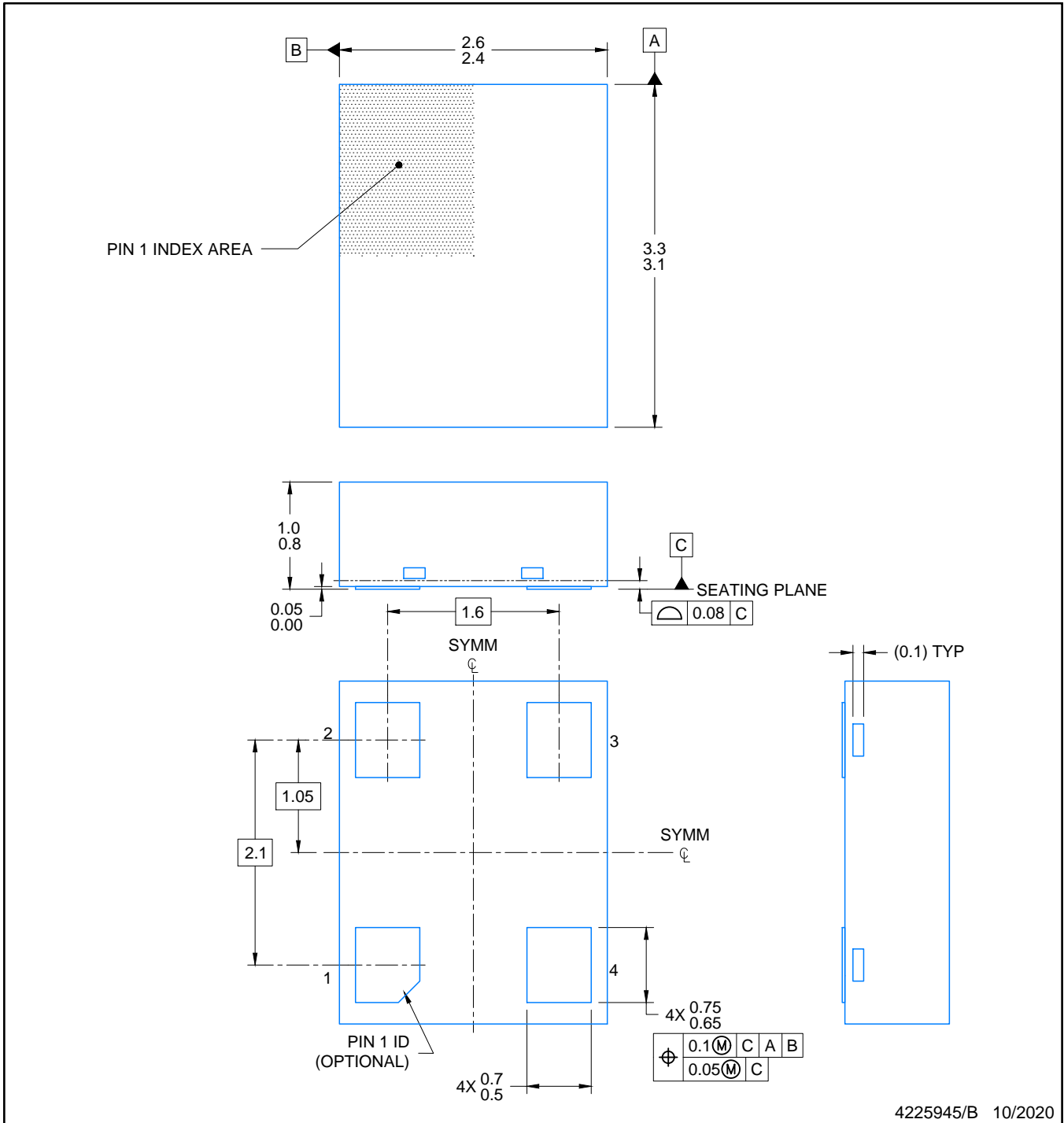

4225945/B 10/2020

NOTES:

- All linear dimensions are in millimeters. Any dimensions in parenthesis are for reference only. Dimensioning and tolerancing per ASME Y14.5M.
- This drawing is subject to change without notice.

EXAMPLE BOARD LAYOUT

DLE0004A

VSON - 1 mm max height

PLASTIC QUAD FLAT PACK-NO LEAD

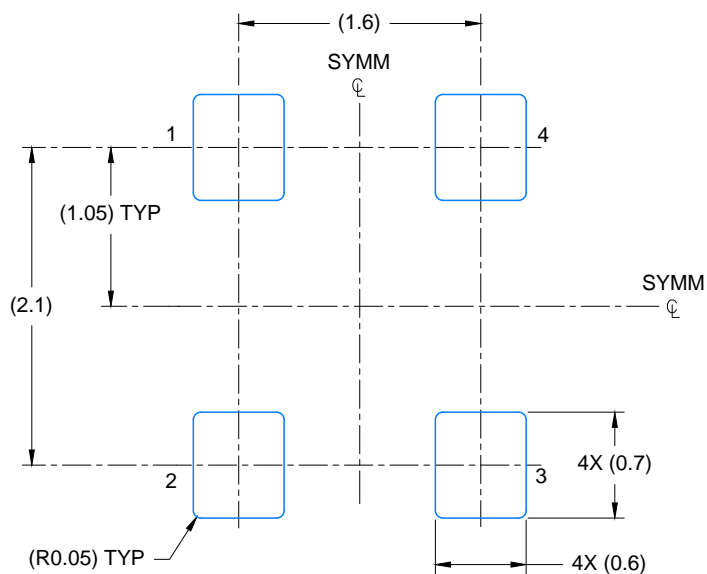

LAND PATTERN EXAMPLE
EXPOSED METAL SHOWN
SCALE: 20X

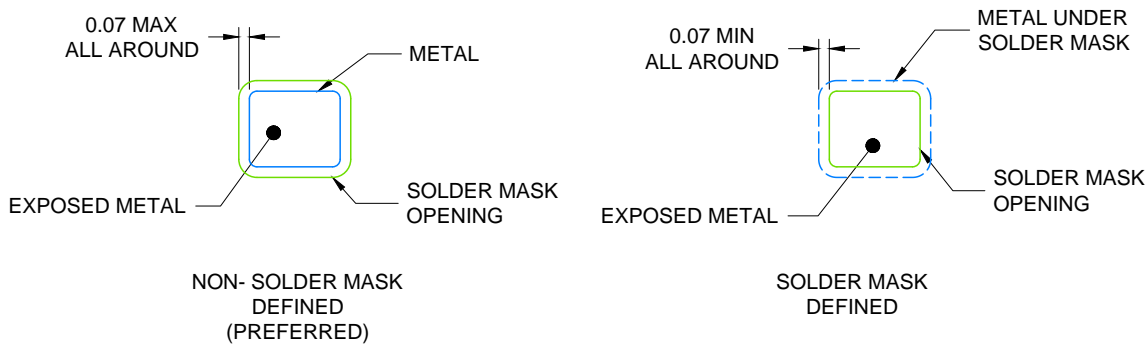

SOLDER MASK DETAILS

4225945/B 10/2020

NOTES: (continued)

- For more information, see Texas Instruments literature number SLUA271 (www.ti.com/lit/slua271) .

EXAMPLE STENCIL DESIGN

VSON - 1 mm max height

DLE0004A

PLASTIC QUAD FLAT PACK-NO LEAD

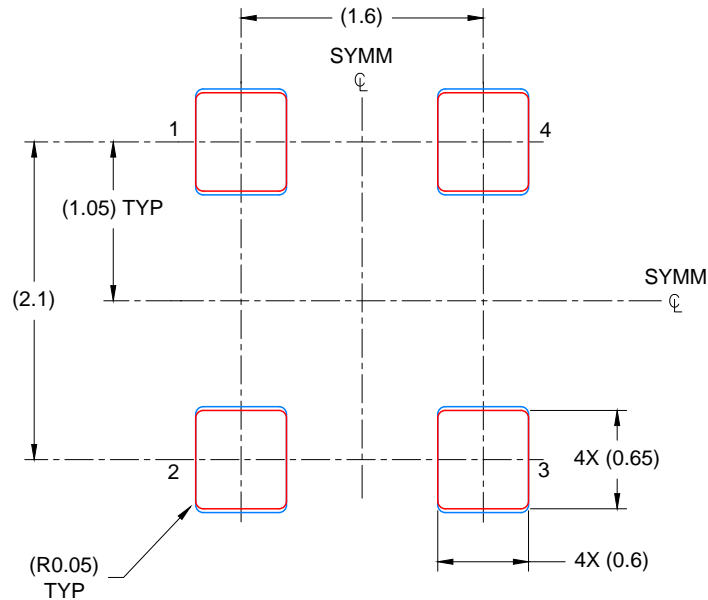

SOLDER PASTE EXAMPLE
BASED ON 0.125 mm THICK STENCIL
PRINTED SOLDER COVERAGE BY AREA UNDER PACKAGE
ALL PADS: 93%
SCALE: 20X

4225945/B 10/2020

NOTES: (continued)

4. Laser cutting apertures with trapezoidal walls and rounded corners may offer better paste release. IPC-7525 may have alternate design recommendations.

GENERIC PACKAGE VIEW

DLF 4

VSON - 1 mm max height

2 x 2.5, 1.65 mm pitch

PLASTIC QUAD FLAT PACK-NO LEAD

This image is a representation of the package family, actual package may vary.
Refer to the product data sheet for package details.

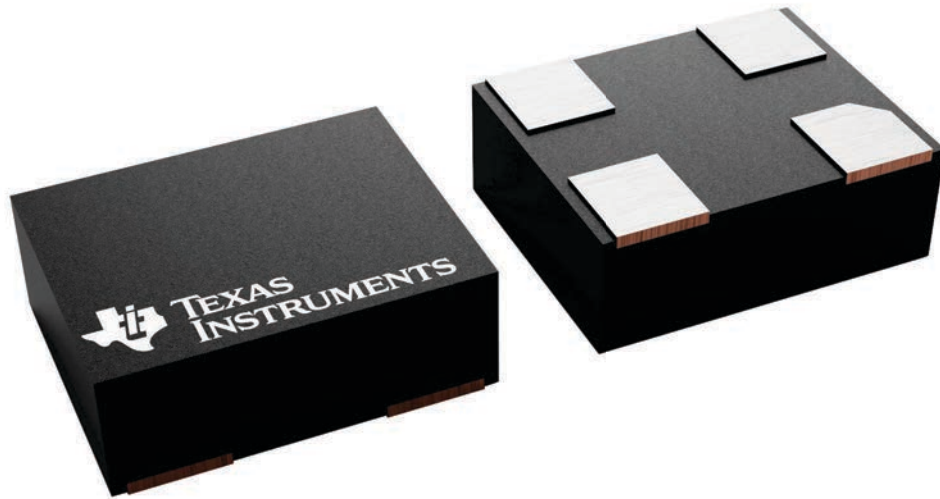

4231598/A

EXAMPLE BOARD LAYOUT

DLF0004A

VSON - 1 mm max height

PLASTIC QUAD FLAT PACK-NO LEAD

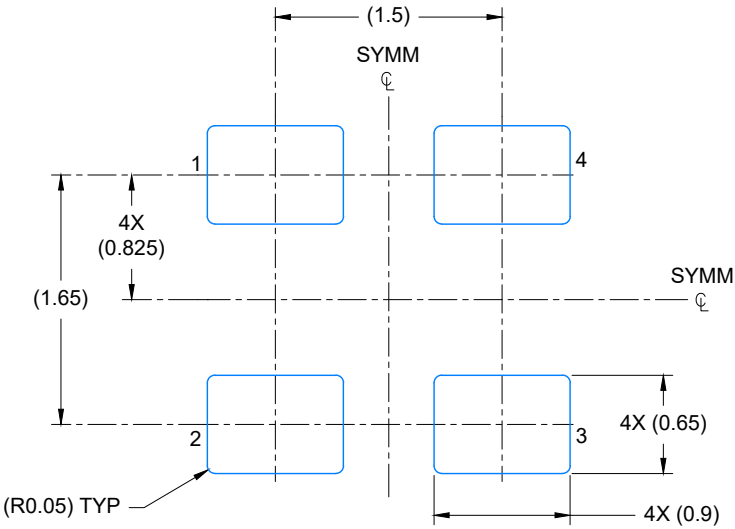

LAND PATTERN EXAMPLE
EXPOSED METAL SHOWN
SCALE: 20X

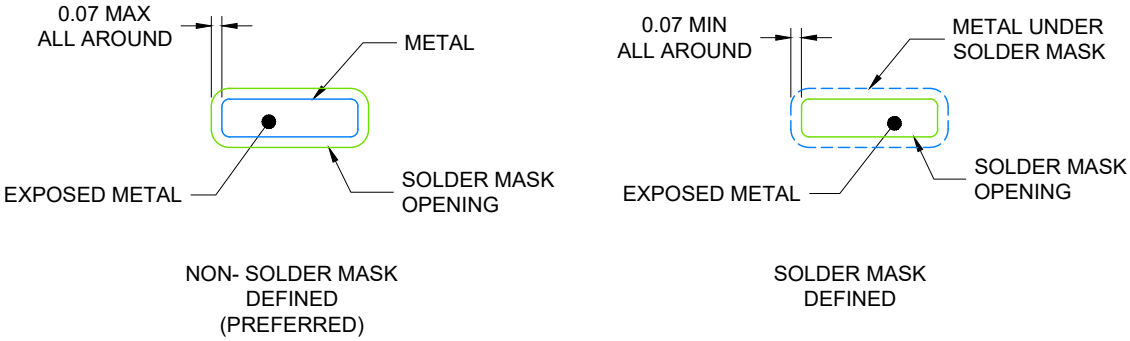

SOLDER MASK DETAILS

4225946/D 03/2023

NOTES: (continued)

- 3. For more information, see Texas Instruments literature number SLUA271 (www.ti.com/lit/slua271).

EXAMPLE STENCIL DESIGN

DLF0004A

VSON - 1 mm max height

PLASTIC QUAD FLAT PACK-NO LEAD

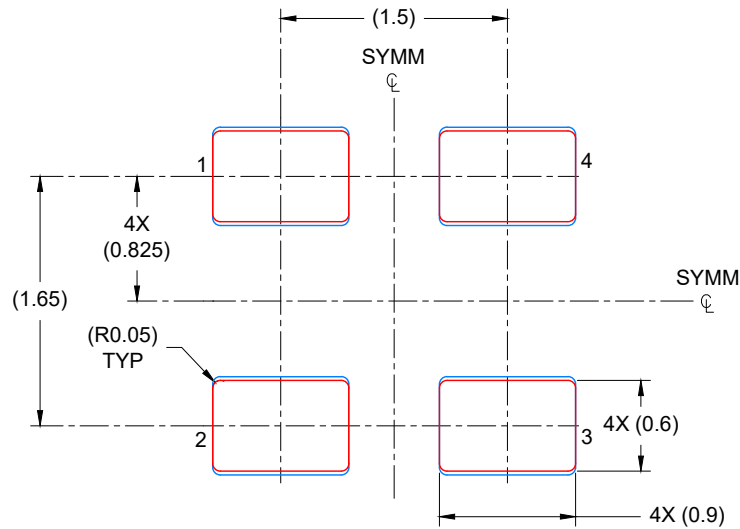

SOLDER PASTE EXAMPLE
BASED ON 0.125 mm THICK STENCIL

PRINTED SOLDER COVERAGE BY AREA UNDER PACKAGE
PADS 1,3,4 & 6: 92%
SCALE: 20X

4225946/D 03/2023

NOTES: (continued)

4. Laser cutting apertures with trapezoidal walls and rounded corners may offer better paste release. IPC-7525 may have alternate design recommendations.

IMPORTANT NOTICE AND DISCLAIMER

TI PROVIDES TECHNICAL AND RELIABILITY DATA (INCLUDING DATA SHEETS), DESIGN RESOURCES (INCLUDING REFERENCE DESIGNS), APPLICATION OR OTHER DESIGN ADVICE, WEB TOOLS, SAFETY INFORMATION, AND OTHER RESOURCES "AS IS" AND WITH ALL FAULTS, AND DISCLAIMS ALL WARRANTIES, EXPRESS AND IMPLIED, INCLUDING WITHOUT LIMITATION ANY IMPLIED WARRANTIES OF MERCHANTABILITY, FITNESS FOR A PARTICULAR PURPOSE OR NON-INFRINGEMENT OF THIRD PARTY INTELLECTUAL PROPERTY RIGHTS.

These resources are intended for skilled developers designing with TI products. You are solely responsible for (1) selecting the appropriate TI products for your application, (2) designing, validating and testing your application, and (3) ensuring your application meets applicable standards, and any other safety, security, regulatory or other requirements.

These resources are subject to change without notice. TI grants you permission to use these resources only for development of an application that uses the TI products described in the resource. Other reproduction and display of these resources is prohibited. No license is granted to any other TI intellectual property right or to any third party intellectual property right. TI disclaims responsibility for, and you will fully indemnify TI and its representatives against, any claims, damages, costs, losses, and liabilities arising out of your use of these resources.

TI's products are provided subject to [TI's Terms of Sale](#) or other applicable terms available either on [ti.com](https://www.ti.com) or provided in conjunction with such TI products. TI's provision of these resources does not expand or otherwise alter TI's applicable warranties or warranty disclaimers for TI products.

TI objects to and rejects any additional or different terms you may have proposed.

Mailing Address: Texas Instruments, Post Office Box 655303, Dallas, Texas 75265

Copyright © 2025, Texas Instruments Incorporated